

GaAs N-channel Dual Gate MES FET

Description

The SGM2014AM is an N-channel dual gate GaAs MES FET for UHF band low-noise amplification. This FET is suitable for a wide range of applications including TV tuners, cellular radios, and DBS IF amplifiers.

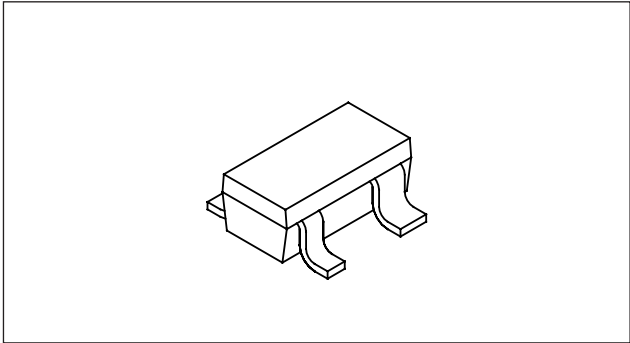

Features

- Low voltage operation
- Low noise: NF = 1.5dB (typ.) at 900MHz
- High gain: Ga = 18dB (typ.) at 900MHz
- Low cross-modulation
- High stability
- Built-in gate-protection diode

Application

UHF band amplifier, mixer and oscillator

Structure

GaAs N-channel dual-gate metal semiconductor field-effect transistor

Absolute Maximum Ratings (Ta = 25°C)

• Drain to source voltage	V _{DSX}	12	V
• Gate 1 to source voltage	V _{G1S}	-5	V
• Gate 2 to source voltage	V _{G2S}	-5	V
• Drain current	I _D	55	mA
• Allowable power dissipation	P _D	150	mW
• Channel temperature	T _{ch}	150	°C
• Storage temperature	T _{stg}	-55 to +150	°C

Sony reserves the right to change products and specifications without prior notice. This information does not convey any license by any implication or otherwise under any patents or other right. Application circuits shown, if any, are typical examples illustrating the operation of the devices. Sony cannot assume responsibility for any problems arising out of the use of these circuits.

Electrical Characteristics

(Ta = 25°C)

Item	Symbol	Condition	Min.	Typ.	Max.	unit
Drain cut-off current	I_{DSX}	$V_{DS} = 12V$ $V_{G1S} = -4V$ $V_{G2S} = 0V$			50	μA
Gate 1 to source current	I_{G1SS}	$V_{G1S} = -4.5V$ $V_{G2S} = 0V$ $V_{DS} = 0V$			-8	μA
Gate 2 to source current	I_{G2SS}	$V_{G2S} = -4.5V$ $V_{G1S} = 0V$ $V_{DS} = 0V$			-8	μA
Drain saturation current	I_{DSS}	$V_{DS} = 5V$ $V_{G1S} = 0V$ $V_{G2S} = 0V$	8		28	mA
Gate 1 to source cut-off voltage	$V_{G1S} (OFF)$	$V_{DS} = 5V$ $I_D = 100\mu A$ $V_{G2S} = 0V$			-2.5	V
Gate 2 to source cut-off voltage	$V_{G2S} (OFF)$	$V_{DS} = 5V$ $I_D = 100\mu A$ $V_{G1S} = 0V$			-2.5	V
Forward transfer admittance	g_m	$V_{DS} = 5V$ $I_D = 10mA$ $V_{G2S} = 1.5V$ $f = 1kHz$	13	17		ms
Input capacitance	C_{iss}	$V_{DS} = 5V$ $I_D = 10mA$ $V_{G2S} = 1.5V$ $f = 1MHz$		0.9	2	pF
Feedback capacitance	C_{rss}	$f = 1MHz$		25	50	fF
Noise figure	NF	$V_{DS} = 5V$ $I_D = 10mA$ $V_{G2S} = 1.5V$ $f = 900MHz$		1.5	2.5	dB
Associated gain	G_a	$f = 900MHz$	15	18		dB

Typical Characteristics (Ta = 25°C)

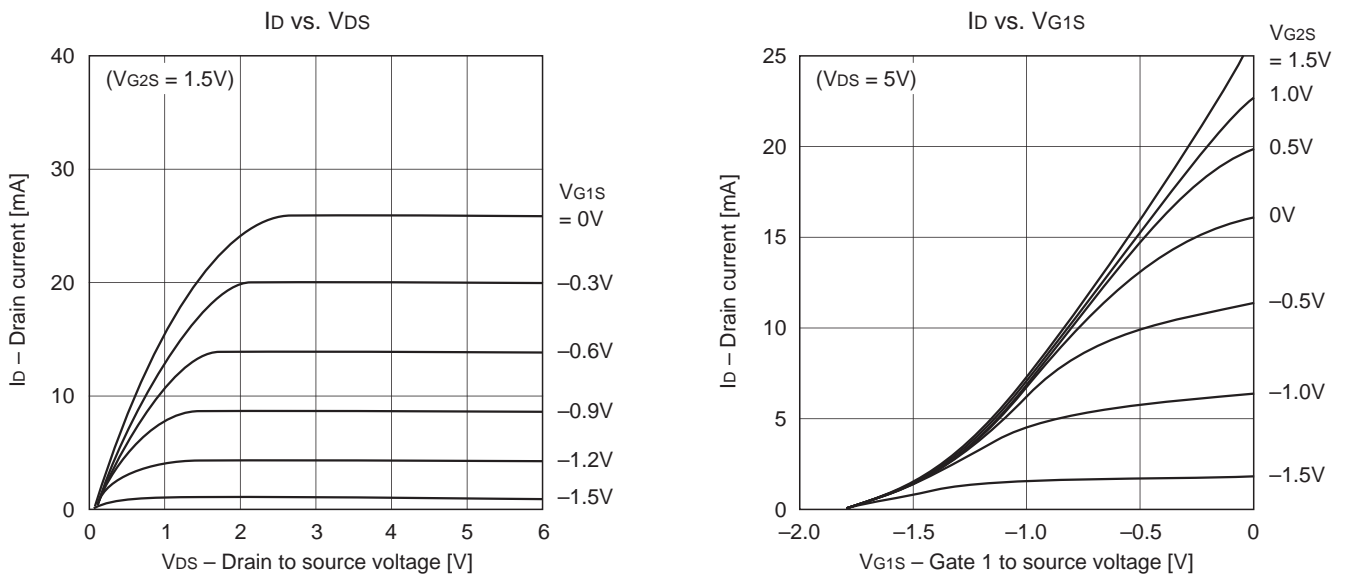

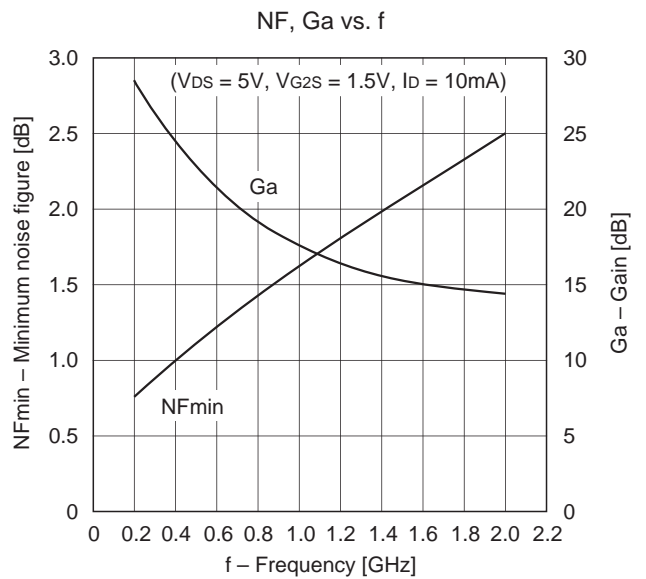
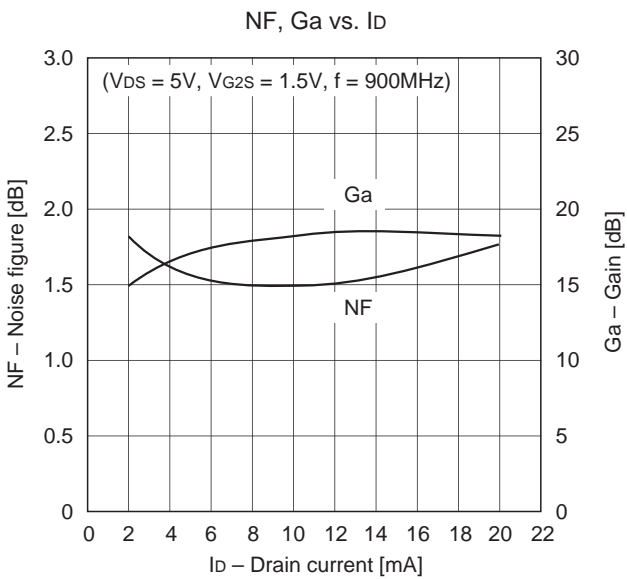
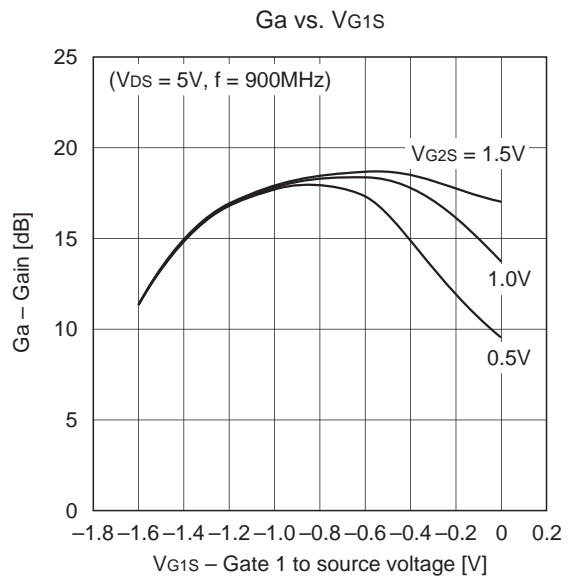
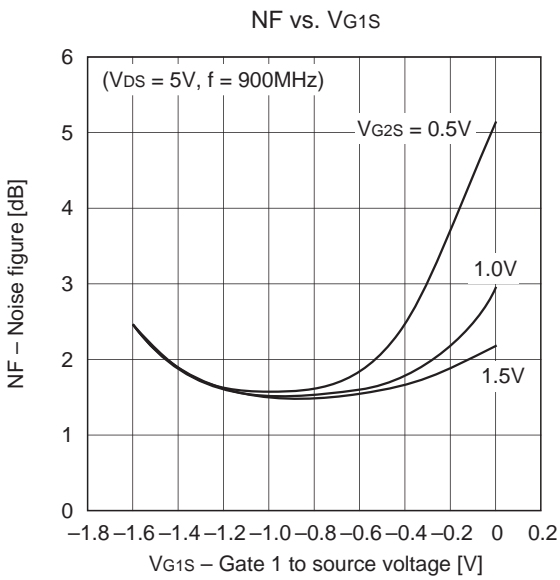
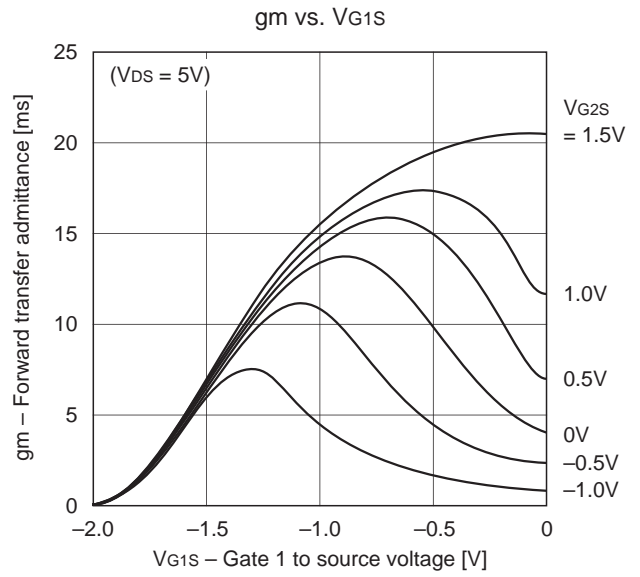
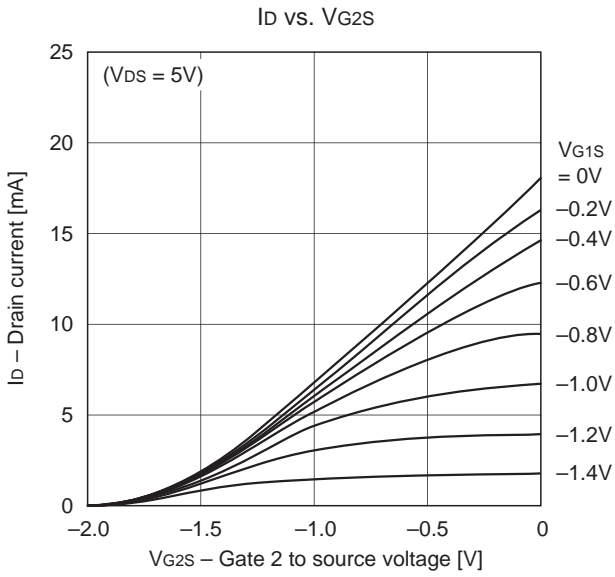

S-parameter vs. Frequency Characteristics ($V_{DS} = 5V$, $V_{G2S} = 1.5V$, $I_D = 10mA$)

($Z_0 = 50\Omega$)

f (MHz)	S11		S21		S12		S22	
	MAG	ANG	MAG	ANG	MAG	ANG	MAG	ANG
100	0.999	-2.8	1.531	175.1	0.001	87.1	0.979	-1.9
200	0.997	-5.9	1.527	170.2	0.003	78.7	0.979	-4.0
300	0.991	-9.0	1.526	165.4	0.003	81.9	0.975	-6.1
400	0.981	-12.3	1.520	160.3	0.005	82.0	0.974	-8.2
500	0.968	-15.5	1.506	155.6	0.006	78.7	0.970	-10.2
600	0.956	-18.9	1.497	150.7	0.008	83.6	0.969	-12.1
700	0.944	-21.8	1.486	146.1	0.008	83.0	0.968	-14.2
800	0.929	-24.7	1.478	141.5	0.009	77.8	0.967	-16.3
900	0.917	-27.4	1.468	136.7	0.010	77.2	0.967	-18.2
1000	0.898	-30.4	1.454	131.8	0.011	79.9	0.967	-20.3
1100	0.877	-32.8	1.440	127.4	0.012	81.0	0.962	-22.3
1200	0.855	-35.4	1.422	122.8	0.012	78.3	0.959	-24.4
1300	0.831	-38.0	1.412	118.4	0.013	76.9	0.956	-26.5
1400	0.809	-40.8	1.399	113.8	0.013	76.6	0.955	-28.9
1500	0.785	-43.3	1.387	109.3	0.013	74.7	0.952	-31.4
1600	0.762	-45.8	1.366	104.6	0.013	76.7	0.950	-33.9
1700	0.737	-48.2	1.349	100.3	0.013	76.4	0.950	-36.9
1800	0.721	-50.5	1.333	95.8	0.013	80.2	0.950	-39.5
1900	0.685	-52.7	1.316	91.5	0.013	79.8	0.949	-42.4
2000	0.655	-54.5	1.298	87.2	0.013	83.2	0.945	-45.0

Noise Figure Characteristics ($V_{DS} = 5V$, $V_{G2S} = 1.5V$, $I_D = 10mA$)

f (MHz)	NFmin (dB)	Gamma Optimum		Rn (Ω)
		ANG	MAG	
200	0.76	0.94	5.8	59.7
300	0.88	0.91	8.4	59.6
400	0.99	0.88	11.0	59.4
500	1.11	0.86	13.4	59.1
600	1.23	0.83	15.6	58.8
700	1.34	0.81	17.8	58.4
800	1.45	0.79	19.9	58.0
900	1.54	0.77	22.0	57.4
1000	1.62	0.75	24.0	56.8
1100	1.71	0.73	25.9	56.2
1200	1.80	0.71	27.8	55.4
1300	1.90	0.69	29.7	54.6
1400	1.99	0.67	31.6	53.8
1500	2.09	0.65	33.5	52.8
1600	2.18	0.63	35.5	51.8
1700	2.26	0.61	37.5	50.7
1800	2.34	0.59	39.5	49.6
1900	2.42	0.56	41.6	48.3
2000	2.50	0.54	43.8	47.0

Package Outline

Unit: mm

M-254

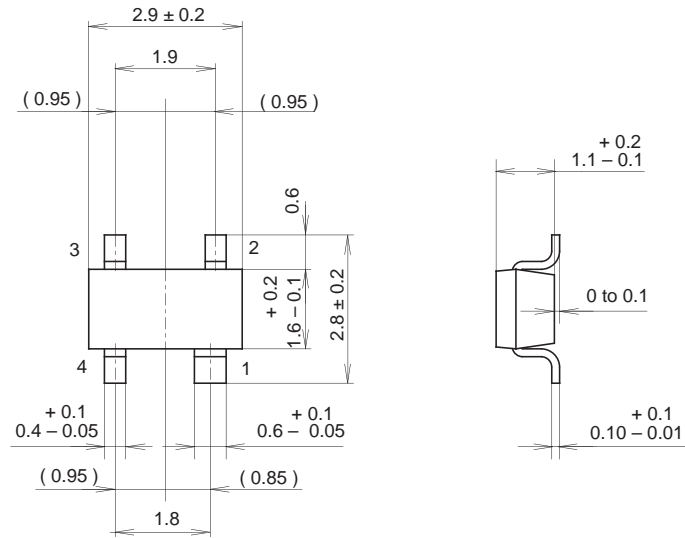

- 1. Source
- 2. Gate1
- 3. Gate2
- 4. Drain

SONY CODE	M-254
EIAJ CODE	_____
JEDEC CODE	_____

PACKAGE MASS	0.01g
--------------	-------