

### FEATURES

- Miniature Package (SOT-23L-6)
- Few External Components
- Internal Rectifier and Regulator
- Wide Input Voltage Range (1.1 to 18 V)
- Selectable Output Voltages
- Single Battery Cell Operation

### DESCRIPTION

The TK1181x series devices generate DC output voltages ranging from 7.2 to 32 V. Each device provides two regulated output voltages selectable by a single jumper. Designed for step-up operation, these devices will operate with an input voltage as low as 1.1 V, thus allowing single battery cell operation.

These converters have a built-in relaxation oscillator. The frequency of operation is determined by external component values. The built-in rectifier combined with an internal temperature compensated reference allows stable output voltages with minimal external components.

These devices are available in a miniature SOT-23L-6 surface mount package. An optimized surface mount inductor is available from TOKO (P/N: 395GN-0091B).

### APPLICATIONS

- Variable Capacitance and PIN Diode Bias
- Portable Instrumentation
- Radio Control Systems
- Mobile Radios
- Cellular Telephones
- Cordless Telephones
- Fiber-Optic Receivers
- Local Area Network (LAN) Receivers
- Battery Operated Equipment

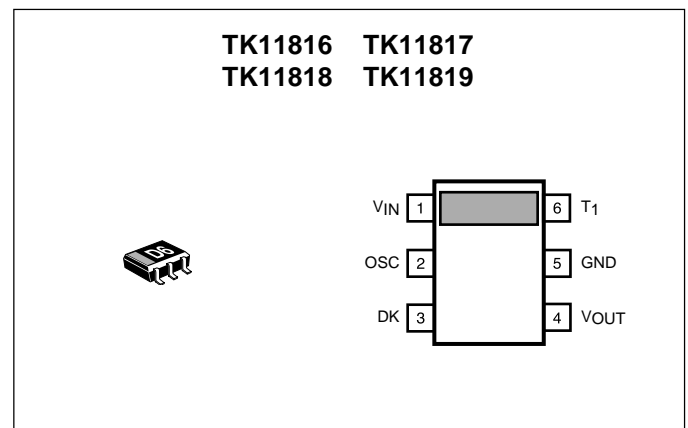

| ORDERING INFORMATION |    |
|----------------------|----|
| TK11816M             | □□ |
| TK11817M             | □□ |
| TK11818M             | □□ |
| TK11819M             | □□ |

Tape/Reel Code  
TAPE/REEL CODE  
TL: Tape Left

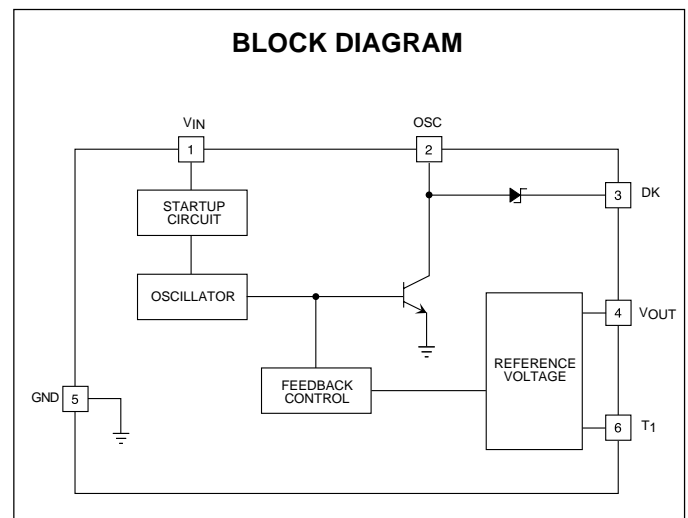

# TK11816, TK11817, TK11818, TK11819

## ABSOLUTE MAXIMUM RATINGS

|   |             |   |                |
|---|-------------|---|----------------|
| Input Voltage .....                     | 20 V        | Operating Voltage Range (TK11818) ..... | 1.1 to 18 V    |
| Power Dissipation (Note 1) .....        | 200 mW      | Operating Voltage Range (TK11819) ..... | 1.1 to 18 V    |
| Junction Temperature .....              | 150 °C      | Storage Temperature Range .....         | -55 to +150 °C |
| Operating Voltage Range (TK11816) ..... | 1.1 to 13 V | Operating Temperature Range .....       | -20 to +70 °C  |
| Operating Voltage Range (TK11817) ..... | 1.1 to 15 V | Lead Soldering Temperature (10 s) ..... | 235 °C         |

## TK11816 ELECTRICAL CHARACTERISTICS

Test Conditions:  $V_{IN} = 5\text{ V}$ ,  $T_A = 25\text{ °C}$  (Notes 3 & 5), unless otherwise specified.

| SYMBOL                    | PARAMETER               | TEST CONDITIONS                                    | MIN  | TYP  | MAX  | UNITS |
|---------------------------|-------------------------|--|------|------|------|-------|
| $I_{IN}$                  | Supply Current          | $V_{OUT} = 12.8\text{ V}, I_{OUT} = 0.1\text{ mA}$ |      | 4.7  | 9.0  | mA    |
|                           |                         | $V_{OUT} = 7.2\text{ V}, I_{OUT} = 1.0\text{ mA}$  |      | 12.1 | 19.0 | mA    |
| $V_{OUT}$                 | Output Voltage          | $1.1\text{ V} \leq V_{IN} \leq 10\text{ V}$        | 12.1 | 12.8 | 13.5 | V     |
|                           |                         | $1.1\text{ V} \leq V_{IN} \leq 6\text{ V}$         | 6.85 | 7.20 | 7.50 | V     |
| $I_{OUT}$                 | Output Current          | $V_{OUT} = 12.8\text{ V}$                          | 3.5  | 4.5  |      | mA    |
|                           |                         | $V_{OUT} = 7.2\text{ V}$                           | 4.0  | 6.0  |      | mA    |
| Load Reg                  | Load Regulation         | (Note 4)   |      | 0.06 | 0.3  | %     |
| $\Delta V_{OUT}/\Delta T$ | Temperature Coefficient | $V_{OUT} = 12.8\text{ V}, I_{OUT} = 0.1\text{ mA}$ |      | 1.01 |      | mV/°C |
|                           |                         | $V_{OUT} = 7.2\text{ V}, I_{OUT} = 0.1\text{ mA}$  |      | 2.02 |      | mV/°C |

## TK11817 ELECTRICAL CHARACTERISTICS

Test Conditions:  $V_{IN} = 5\text{ V}$ ,  $T_A = 25\text{ °C}$  (Notes 3 & 5), unless otherwise specified.

| SYMBOL                    | PARAMETER               | TEST CONDITIONS                                    | MIN  | TYP  | MAX  | UNITS |
|---------------------------|-------------------------|--|------|------|------|-------|
| $I_{IN}$                  | Supply Current          | $V_{OUT} = 16.8\text{ V}, I_{OUT} = 0.1\text{ mA}$ |      | 4.7  | 9.0  | mA    |
|                           |                         | $V_{OUT} = 9.3\text{ V}, I_{OUT} = 1.0\text{ mA}$  |      | 12.1 | 19.0 | mA    |
| $V_{OUT}$                 | Output Voltage          | $1.1\text{ V} \leq V_{IN} \leq 15\text{ V}$        | 16.0 | 16.8 | 17.6 | V     |
|                           |                         | $1.1\text{ V} \leq V_{IN} \leq 8\text{ V}$         | 8.85 | 9.30 | 9.80 | V     |
| $I_{OUT}$                 | Output Current          | $V_{OUT} = 16.8\text{ V}$                          | 3.5  | 4.5  |      | mA    |
|                           |                         | $V_{OUT} = 9.3\text{ V}$                           | 4.0  | 6.0  |      | mA    |
| Load Reg                  | Load Regulation         | (Note 4)   |      | 0.06 | 0.3  | %     |
| $\Delta V_{OUT}/\Delta T$ | Temperature Coefficient | $V_{OUT} = 16.8\text{ V}, I_{OUT} = 0.1\text{ mA}$ |      | 1.81 |      | mV/°C |
|                           |                         | $V_{OUT} = 9.3\text{ V}, I_{OUT} = 0.1\text{ mA}$  |      | 2.31 |      | mV/°C |

## TK11818 ELECTRICAL CHARACTERISTICS

Test Conditions:  $V_{IN} = 5\text{ V}$ ,  $T_A = 25\text{ °C}$  (Notes 3 & 5), unless otherwise specified.

| SYMBOL                    | PARAMETER               | TEST CONDITIONS                                       | MIN  | TYP  | MAX  | UNITS |
|---------------------------|-------------------------|---|------|------|------|-------|
| $I_{IN}$                  | Supply Current          | $V_{OUT} = 28\text{ V}$ , $I_{OUT} = 0.1\text{ mA}$   |      | 4.7  | 9.0  | mA    |
|                           |                         | $V_{OUT} = 20.4\text{ V}$ , $I_{OUT} = 1.0\text{ mA}$ |      | 12.1 | 19.0 | mA    |
| $V_{OUT}$                 | Output Voltage          | $1.1\text{ V} \leq V_{IN} \leq 18\text{ V}$           | 26.4 | 28.0 | 29.6 | V     |
|                           |                         | $1.1\text{ V} \leq V_{IN} \leq 18\text{ V}$           | 19.3 | 20.4 | 21.5 | V     |
| $I_{OUT}$                 | Output Current          | $V_{OUT} = 28\text{ V}$                               | 1.8  | 3.0  |      | mA    |
|                           |                         | $V_{OUT} = 20.4\text{ V}$                             | 2.5  | 4.0  |      | mA    |
| Load Reg                  | Load Regulation         | (Note 4)  |      | 0.06 | 0.3  | %     |
| $\Delta V_{OUT}/\Delta T$ | Temperature Coefficient | $V_{OUT} = 28\text{ V}$ , $I_{OUT} = 0.1\text{ mA}$   |      | 0.2  |      | mV/°C |
|                           |                         | $V_{OUT} = 20.4\text{ V}$ , $I_{OUT} = 0.1\text{ mA}$ |      | 0.6  |      | mV/°C |

## TK11819 ELECTRICAL CHARACTERISTICS

Test Conditions:  $V_{IN} = 5\text{ V}$ ,  $T_A = 25\text{ °C}$  (Notes 3 & 5), unless otherwise specified.

| SYMBOL                    | PARAMETER               | TEST CONDITIONS                                     | MIN  | TYP  | MAX  | UNITS |
|---------------------------|-------------------------|---|------|------|------|-------|
| $I_{IN}$                  | Supply Current          | $V_{OUT} = 32\text{ V}$ , $I_{OUT} = 0.1\text{ mA}$ |      | 4.7  | 9.0  | mA    |
|                           |                         | $V_{OUT} = 24\text{ V}$ , $I_{OUT} = 1.0\text{ mA}$ |      | 12.1 | 19.0 | mA    |
| $V_{OUT}$                 | Output Voltage          | $1.1\text{ V} \leq V_{IN} \leq 18\text{ V}$         | 30.0 | 32.0 | 34.0 | V     |
|                           |                         | $1.1\text{ V} \leq V_{IN} \leq 18\text{ V}$         | 22.5 | 24.0 | 25.5 | V     |
| $I_{OUT}$                 | Output Current          | $V_{OUT} = 32\text{ V}$                             | 1.8  | 3.0  |      | mA    |
|                           |                         | $V_{OUT} = 24\text{ V}$                             | 2.5  | 4.0  |      | mA    |
| Load Reg                  | Load Regulation         | (Note 4)  |      | 0.06 | 0.3  | %     |
| $\Delta V_{OUT}/\Delta T$ | Temperature Coefficient | $V_{OUT} = 32\text{ V}$ , $I_{OUT} = 0.1\text{ mA}$ |      | 0.91 |      | mV/°C |
|                           |                         | $V_{OUT} = 24\text{ V}$ , $I_{OUT} = 0.1\text{ mA}$ |      | 1.37 |      | mV/°C |

Note 1: Power dissipation is 400 mW when mounted. Derate at 3.2 mW/°C for operation above 25 °C. Power dissipation is 200 mW in free air. Derate at 1.6 mW/°C for operation above 25 °C.

Note 2: When operating below 25 °C, the output capacitor degradation may increase output ripple noise.

Note 3:  $V_{IN} = 5.0\text{ V}$ , No load.

Note 4: Load Regulation =  $(\Delta V_{OUT} / V_{OUT}) \times 100\%$ , where  $\Delta V_{OUT} = V_{OUT}(\text{no load}) - V_{OUT}(I_{OUT} = 1.0\text{ mA})$

Note 5: Specifications are based upon a Toko 395GN-0091IB inductor. The use of other inductors may degrade performance.

Note 6: See Output Voltage Selection Table for connections to obtain desired output voltage.

# TK11816, TK11817, TK11818, TK11819

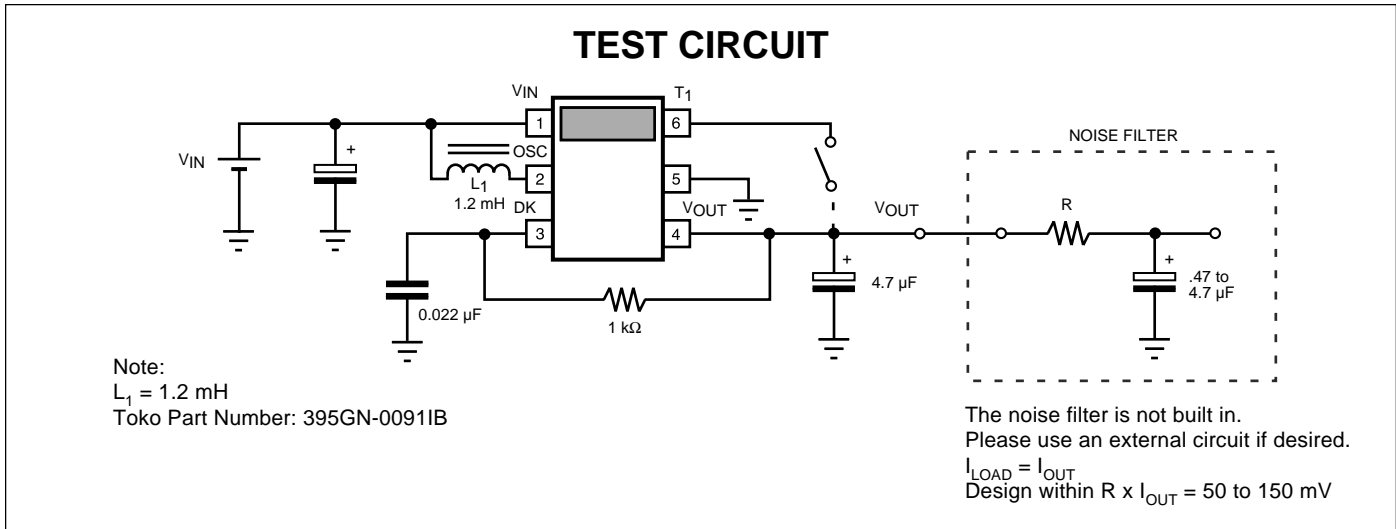

## OUTPUT VOLTAGE SELECTION

| PART NUMBER | MARKING | OUTPUT VOLTAGE         |                            |
|-------------|---------|------------------------|----------------------------|
|             |         | $V_{OUT} - T_1$ (OPEN) | $V_{OUT} - T_1$ (JUMPERED) |
| TK11816     | D6      | 12.8 V                 | 7.2 V                      |
| TK11817     | D7      | 16.8 V                 | 9.3 V                      |
| TK11818     | D8      | 28.0 V                 | 20.4 V                     |
| TK11819     | D9      | 32.0 V                 | 24.0 V                     |

**TYPICAL PERFORMANCE CHARACTERISTICS**

$T_A = 25\text{ }^\circ\text{C}$ , unless otherwise specified.

**TK11816 ( $V_{OUT} - T_1$  JUMPERED)**

OUTPUT VOLTAGE vs. OUTPUT CURRENT

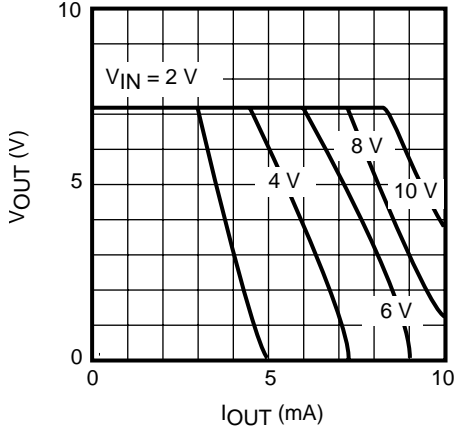

OUTPUT VOLTAGE CHANGE vs. TEMPERATURE

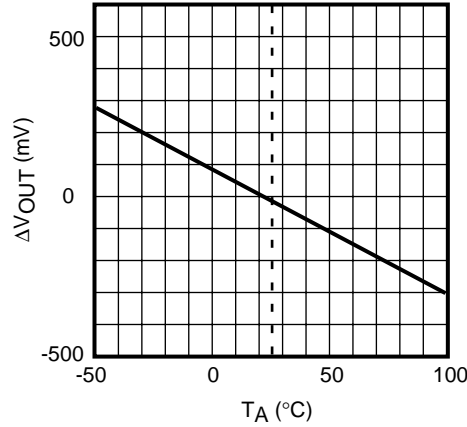

OUTPUT VOLTAGE AND SUPPLY CURRENT vs. INPUT VOLTAGE

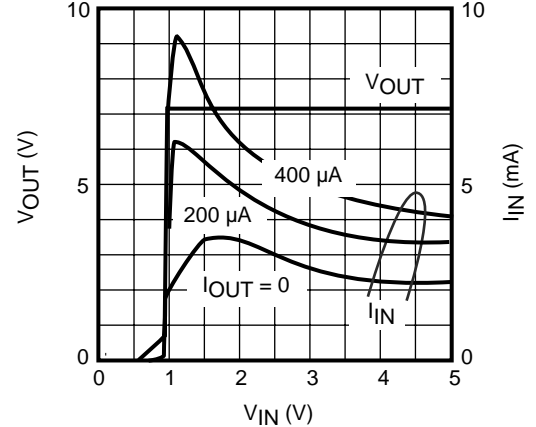

**TK11816 ( $V_{OUT} - T_1$  OPEN)**

OUTPUT VOLTAGE vs. OUTPUT CURRENT

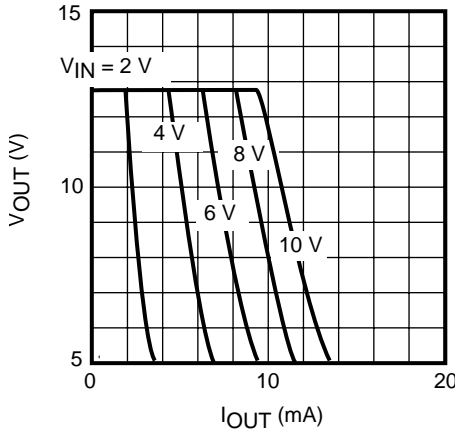

OUTPUT VOLTAGE CHANGE vs. TEMPERATURE

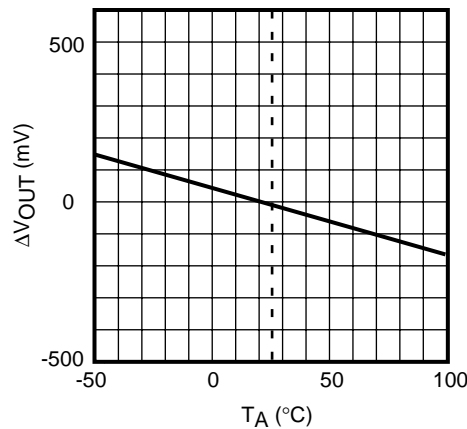

OUTPUT VOLTAGE AND SUPPLY CURRENT vs. INPUT VOLTAGE

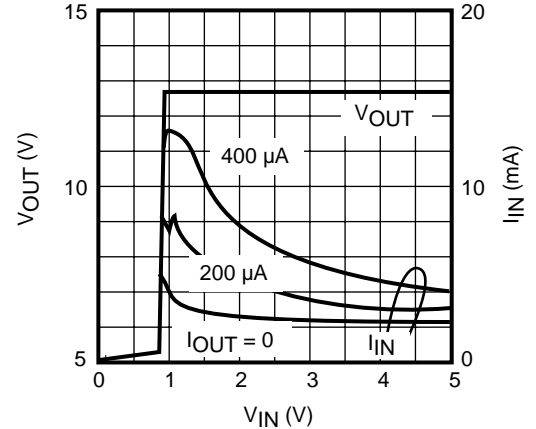

**TK11817 ( $V_{OUT} - T_1$  JUMPERED)**

OUTPUT VOLTAGE vs. OUTPUT CURRENT

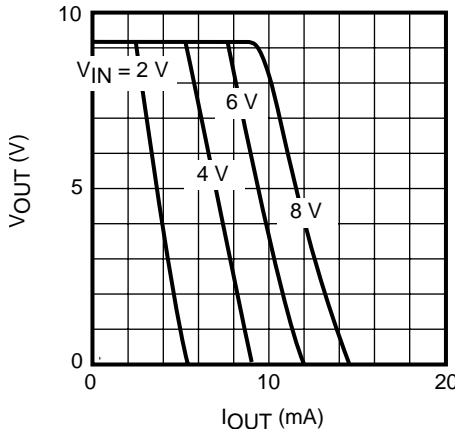

OUTPUT VOLTAGE CHANGE vs. TEMPERATURE

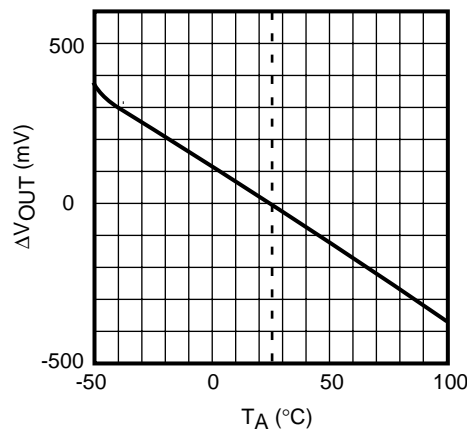

OUTPUT VOLTAGE AND SUPPLY CURRENT vs. INPUT VOLTAGE

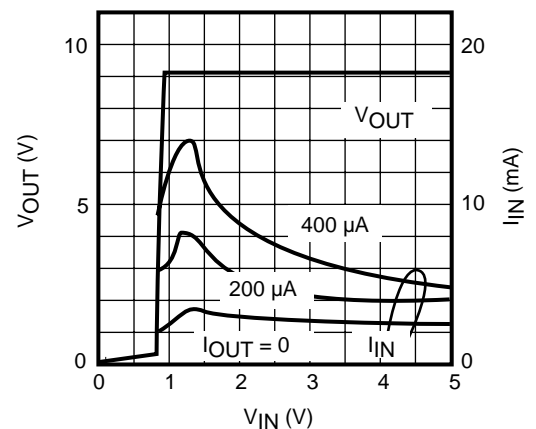

# TK11816, TK11817, TK11818, TK11819

## TYPICAL PERFORMANCE CHARACTERISTICS (CONT.)

$T_A = 25\text{ }^\circ\text{C}$ , unless otherwise specified.

### TK11817 ( $V_{OUT} - T_1$ OPEN)

OUTPUT VOLTAGE vs. OUTPUT CURRENT

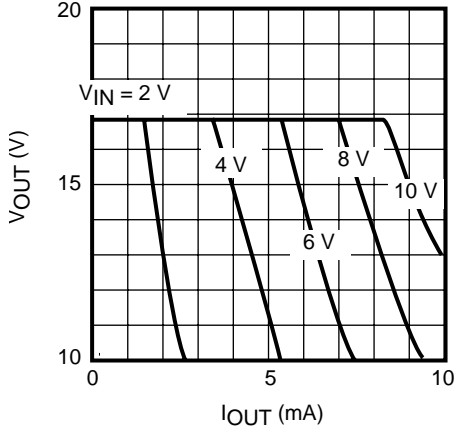

OUTPUT VOLTAGE CHANGE vs. TEMPERATURE

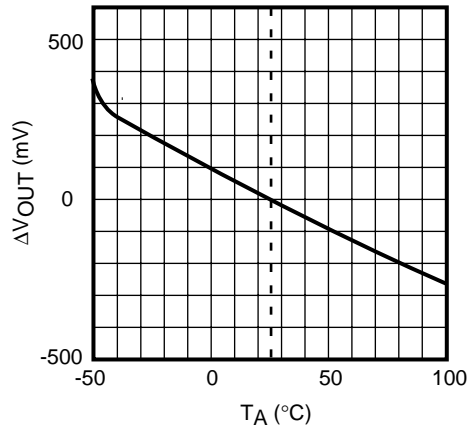

OUTPUT VOLTAGE AND SUPPLY CURRENT vs. INPUT VOLTAGE

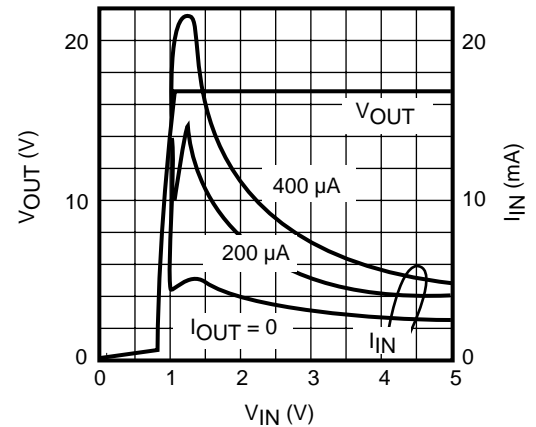

### TK11818 ( $V_{OUT} - T_1$ JUMPED)

OUTPUT VOLTAGE vs. OUTPUT CURRENT

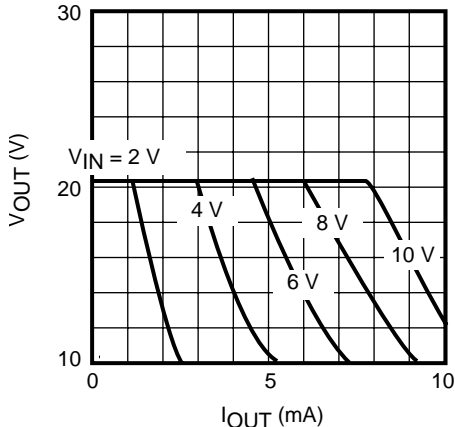

OUTPUT VOLTAGE CHANGE vs. TEMPERATURE

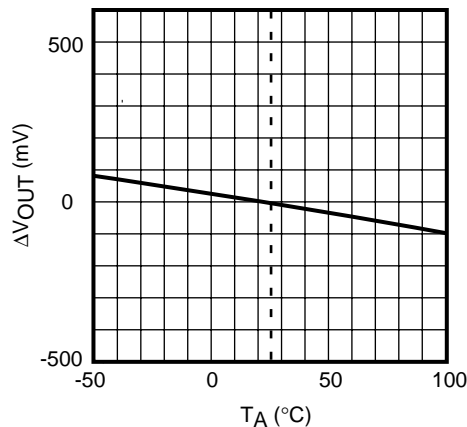

OUTPUT VOLTAGE AND SUPPLY CURRENT vs. INPUT VOLTAGE

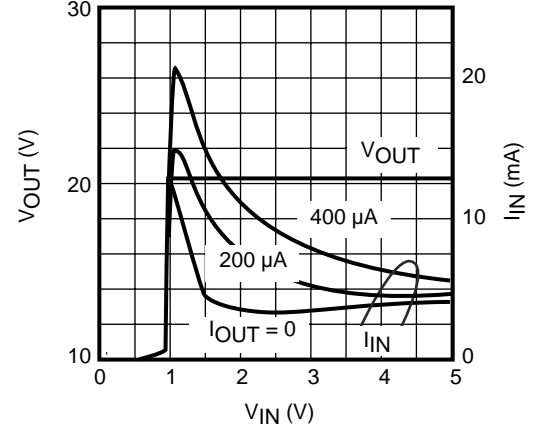

### TK11818 ( $V_{OUT} - T_1$ OPEN)

OUTPUT VOLTAGE vs. OUTPUT CURRENT

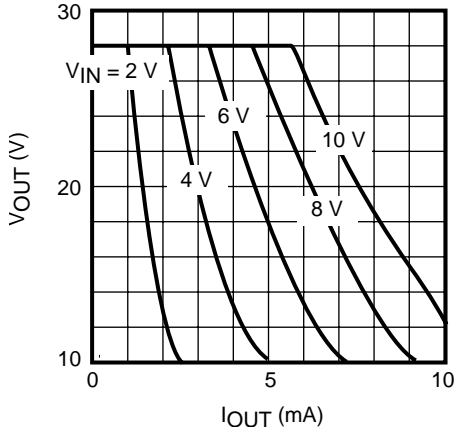

OUTPUT VOLTAGE CHANGE vs. TEMPERATURE

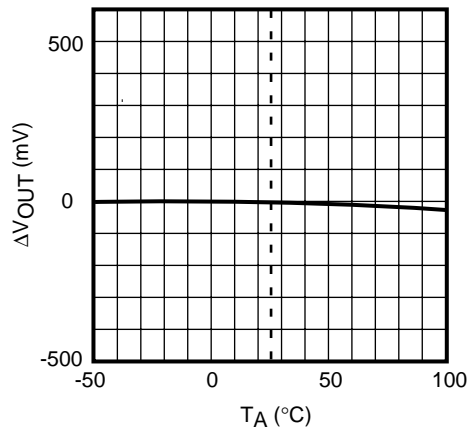

OUTPUT VOLTAGE AND SUPPLY CURRENT vs. INPUT VOLTAGE

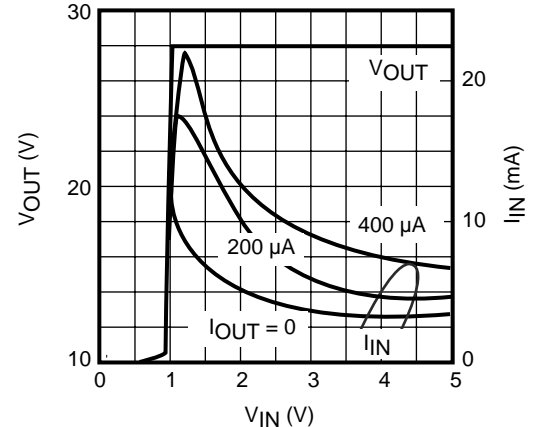

**TYPICAL PERFORMANCE CHARACTERISTICS (CONT.)**

$T_A = 25\text{ }^\circ\text{C}$ , unless otherwise specified.

**TK11819 ( $V_{OUT} - T_1$  JUMPERED)**

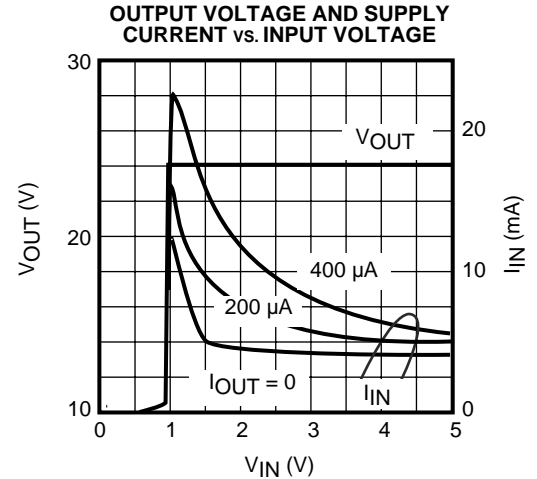
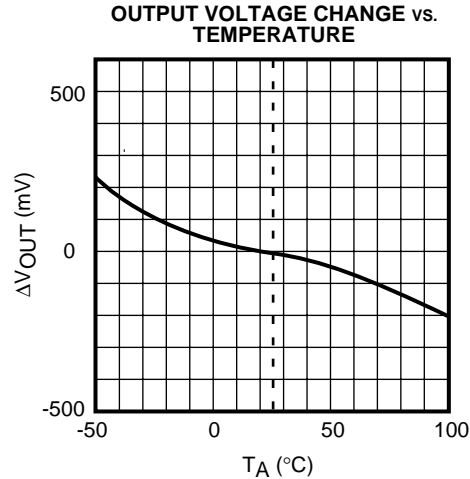
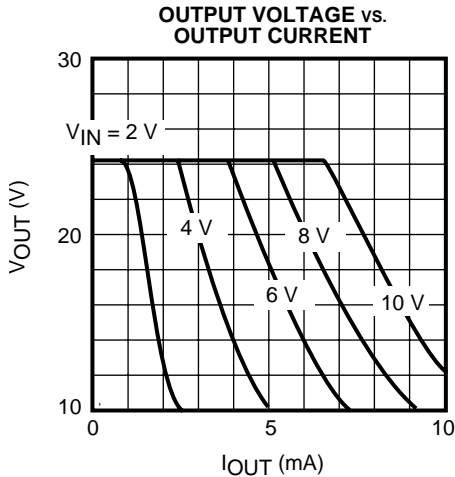

**TK11819 ( $V_{OUT} - T_1$  OPEN)**

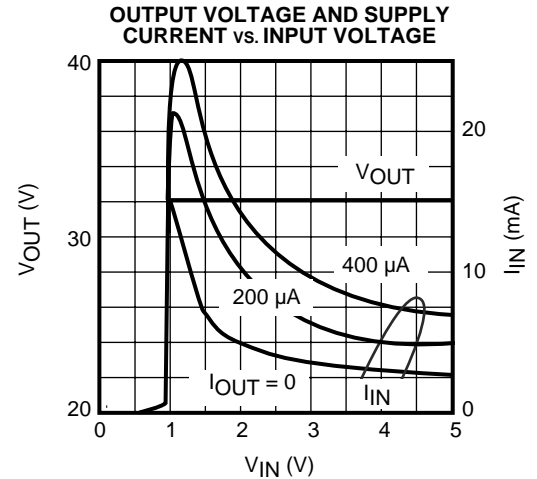
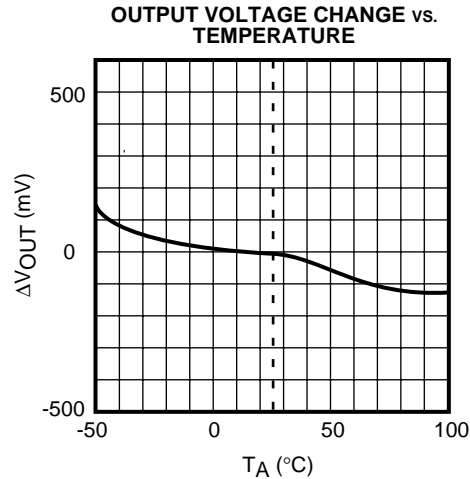
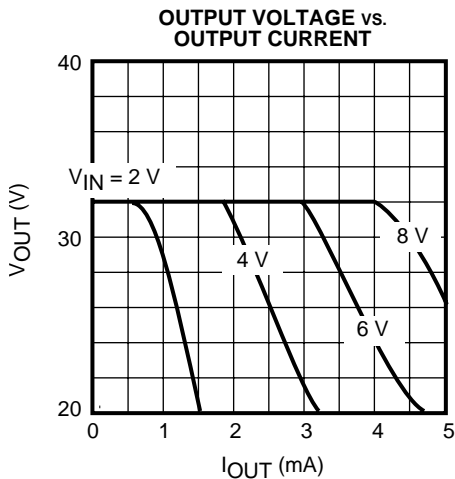

**APPLICATION INFORMATION**

**HANDLING MOLDED RESIN PACKAGES**

All plastic molded packages absorb some moisture from the air. If moisture absorption occurs prior to soldering the device onto the printed circuit board, increased separation of the lead from the plastic molding may occur, degrading the moisture barrier characteristics of the device. This property of plastic molding compounds should not be overlooked, particularly in the case of very small packages, where the plastic is very thin. In order to preserve the original moisture barrier properties of the package, devices are stored and shipped in moisture proof bags, filled with dry air. The bags should not be opened or damaged prior to the actual use of the devices. If this is unavoidable, the devices should be stored in a low relative humidity environment (40 to 65%) or in an enclosed environment with desiccant.

# TK11816, TK11817, TK11818, TK11819

## PACKAGE OUTLINE

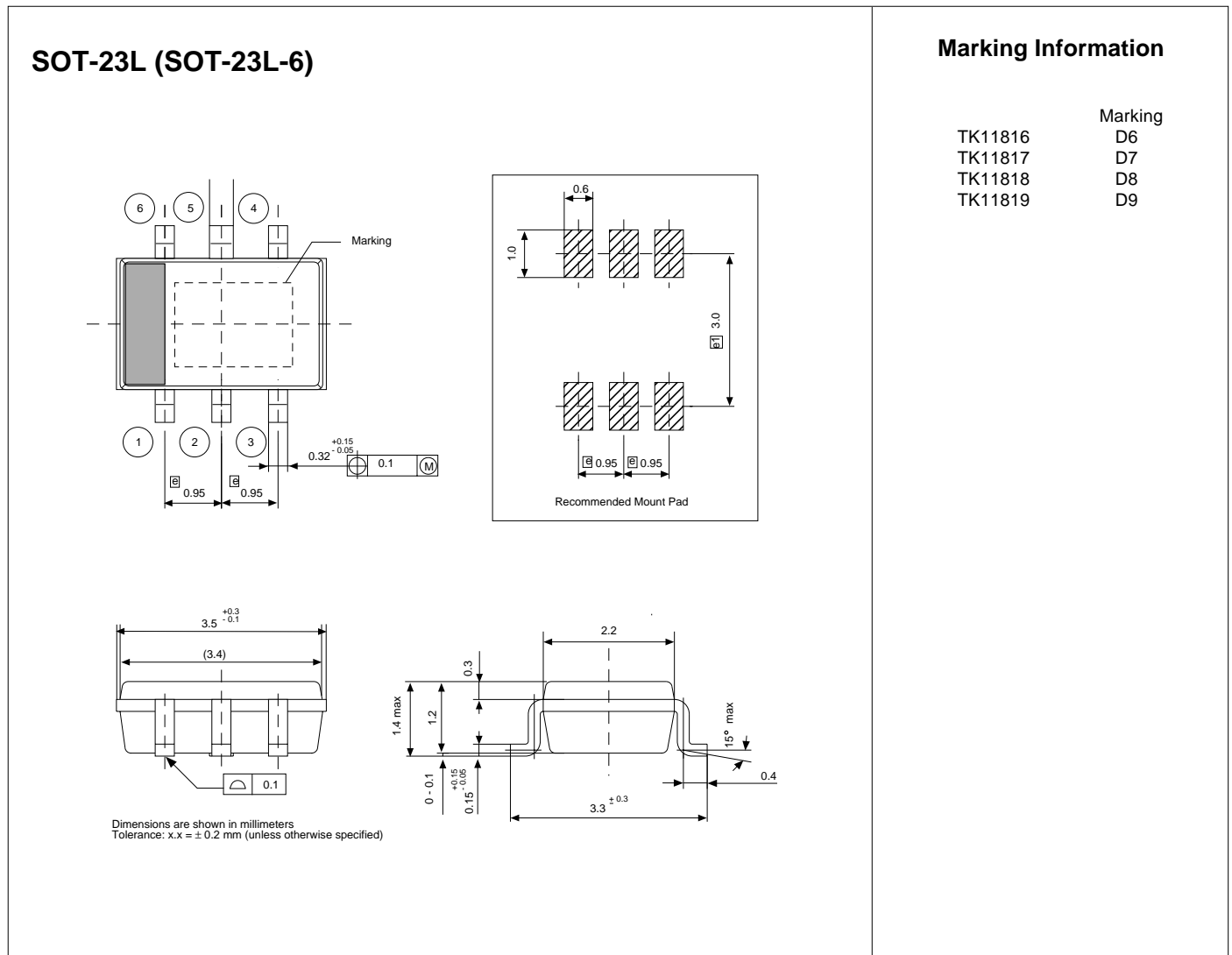

**Toko America, Inc. Headquarters**  
 1250 Feehanville Drive, Mount Prospect, Illinois 60056  
 Tel: (847) 297-0070 Fax: (847) 699-7864

### TOKO AMERICA REGIONAL OFFICES

**Midwest Regional Office**  
 Toko America, Inc.  
 1250 Feehanville Drive  
 Mount Prospect, IL 60056  
 Tel: (847) 297-0070  
 Fax: (847) 699-7864

**Western Regional Office**  
 Toko America, Inc.  
 2480 North First Street, Suite 260  
 San Jose, CA 95131  
 Tel: (408) 432-8281  
 Fax: (408) 943-9790

**Eastern Regional Office**  
 Toko America, Inc.  
 107 Mill Plain Road  
 Danbury, CT 06811  
 Tel: (203) 748-6871  
 Fax: (203) 797-1223

**Semiconductor Technical Support**  
 Toko Design Center  
 4755 Forge Road  
 Colorado Springs, CO 80907  
 Tel: (719) 528-2200  
 Fax: (719) 528-2375

Visit our Internet site at <http://www.tokoam.com>

The information furnished by TOKO, Inc. is believed to be accurate and reliable. However, TOKO reserves the right to make changes or improvements in the design, specification or manufacture of its products without further notice. TOKO does not assume any liability arising from the application or use of any product or circuit described herein, nor for any infringements of patents or other rights of third parties which may result from the use of its products. No license is granted by implication or otherwise under any patent or patent rights of TOKO, Inc.