

LOW DROPOUT REGULATOR

FEATURES

- Low Dropout Voltage
- Low Quiescent Current
- Very Stable Output
- Low Noise (35 μ Vrms)
- Miniature Package (SOT-25)

APPLICATIONS

- Battery Powered Systems
- Portable Consumer Equipment
- Cordless Telephones
- Personal Communications Equipment
- Radio Control Systems
- Toys
- Low Voltage Systems

DESCRIPTION

TK712xx is a low dropout, linear regulator. Since a PNP power transistor is used, dropout voltage is very low, making it possible to maintain stable output voltage even as the battery decreases. This allows longer battery life. The TK712xx has a noise bypass pin available for noise reduction.

The TK712xx is available in a miniature SOT-25 surface mount package.

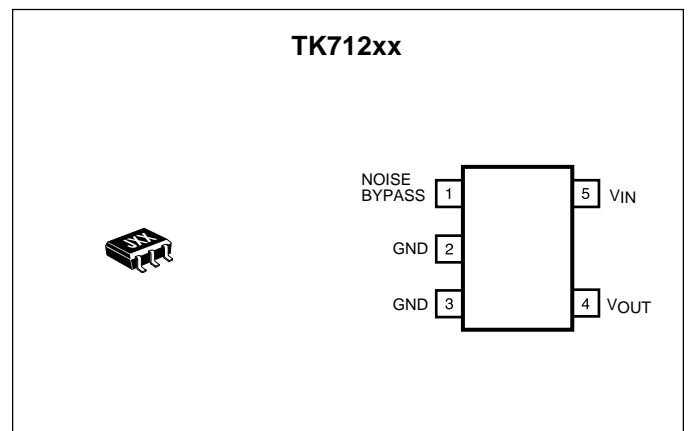

ORDERING INFORMATION

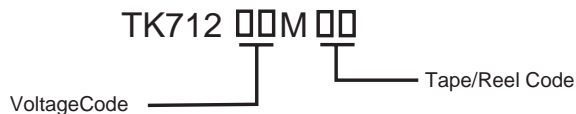

VOLTAGE CODE	
20 = 2.0 V	35 = 3.5 V
25 = 2.5 V	40 = 4.0 V
28 = 2.8 V	45 = 4.5 V
30 = 3.0 V	50 = 5.0 V
33 = 3.3 V	

TAPE/REEL CODE
TL: Tape Left

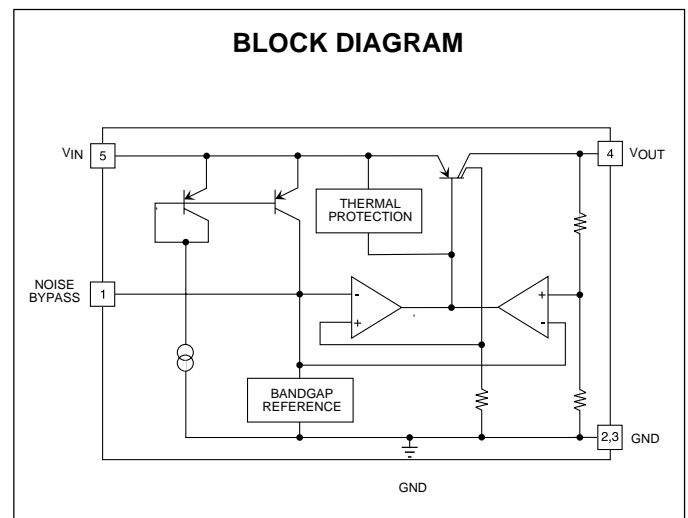

TK712xx

ABSOLUTE MAXIMUM RATINGS

Input Voltage 15 V
Power Dissipation (Note 1) 350 mW
Operating Voltage Range 1.4 to 14 V
Junction Temperature 150 °C
Storage Temperature Range -55 to +150 °C
Operating Temperature Range -30 to +80 °C
Lead Soldering Temperature (10 s) 235 °C

TK71220 ELECTRICAL CHARACTERISTICS

Test Conditions: $V_{IN} = 3\text{ V}$, $T_A = 25\text{ °C}$, unless otherwise specified.

SYMBOL	PARAMETER	TEST CONDITIONS	MIN	TYP	MAX	UNITS
I_Q	Quiescent Current	$V_{IN} = 3.0\text{ V}$, $I_{OUT} = 0\text{ mA}$		130	300	μA
		$V_{IN} = 1.8\text{ V}$, $I_{OUT} = 0\text{ mA}$		1.4	3.0	mA
V_{OUT}	Regulated Output Voltage	$V_{IN} = 3.0\text{ V}$, $I_{OUT} = 10\text{ mA}$	1.9	2.0	2.1	V
V_{DROP}	Dropout Voltage	$I_{OUT} = 30\text{ mA}$		100	200	mV
I_{OUT}	Output Current		100	160		mA
I_{GND}	Ground Current	$V_{IN} = 3.0\text{ V}$, $I_{OUT} = 30\text{ mA}$		1.5	3.5	mA
Line Reg	Line Regulation	$V_{IN} = 3.0\text{ to }13.0\text{ V}$		10	30	mV
Load Reg	Load Regulation	$I_{OUT} = 1\text{ to }60\text{ mA}$		20	40	mV
RR	Ripple Rejection	$C_L = 3.3\text{ }\mu\text{F}$, $f = 400\text{ Hz}$, $I_{OUT} = 10\text{ mA}$		63		dB
V_{ref}	Noise Bypass Terminal Voltage			1.27		V
$\Delta V_{OUT}/\Delta T$	Temperature Coefficient			0.15		mV/°C

Note 1: Power dissipation is 350 mW when mounted as recommended. Derate at 2.8 mW/°C for operation above 25 °C.

TK71225 ELECTRICAL CHARACTERISTICSTest Conditions: $V_{IN} = 3.5\text{ V}$, $T_A = 25\text{ }^\circ\text{C}$, unless otherwise specified.

SYMBOL	PARAMETER	TEST CONDITIONS	MIN	TYP	MAX	UNITS
I_Q	Quiescent Current	$V_{IN} = 3.5\text{ V}$, $I_{OUT} = 0\text{ mA}$		130	300	μA
		$V_{IN} = 2.0\text{ V}$, $I_{OUT} = 0\text{ mA}$		1.4	3.0	mA
V_{OUT}	Regulated Output Voltage	$V_{IN} = 3.5\text{ V}$, $I_{OUT} = 10\text{ mA}$	2.4	2.5	2.6	V
V_{DROD}	Dropout Voltage	$I_{OUT} = 30\text{ mA}$		100	200	mV
I_{OUT}	Output Current		100	160		mA
I_{GND}	Ground Current	$V_{IN} = 3.5\text{ V}$, $I_{OUT} = 30\text{ mA}$		1.5	3.5	mA
Line Reg	Line Regulation	$V_{IN} = 3.5\text{ to }13.5\text{ V}$		10	30	mV
Load Reg	Load Regulation	$I_{OUT} = 1\text{ to }60\text{ mA}$		20	40	mV
RR	Ripple Rejection	$C_L = 3.3\text{ }\mu\text{F}$, $f = 400\text{ Hz}$, $I_{OUT} = 10\text{ mA}$		63		dB
V_{ref}	Noise Bypass Terminal Voltage			1.27		V
$\Delta V_{OUT}/\Delta T$	Temperature Coefficient			0.15		mV/ $^\circ\text{C}$

TK71228 ELECTRICAL CHARACTERISTICSTest Conditions: $V_{IN} = 3.8\text{ V}$, $T_A = 25\text{ }^\circ\text{C}$, unless otherwise specified.

SYMBOL	PARAMETER	TEST CONDITIONS	MIN	TYP	MAX	UNITS
I_Q	Quiescent Current	$V_{IN} = 3.8\text{ V}$, $I_{OUT} = 0\text{ mA}$		130	300	μA
		$V_{IN} = 2.5\text{ V}$, $I_{OUT} = 0\text{ mA}$		1.4	3.0	mA
V_{OUT}	Regulated Output Voltage	$V_{IN} = 3.8\text{ V}$, $I_{OUT} = 10\text{ mA}$	2.7	2.8	2.9	V
V_{DROD}	Dropout Voltage	$I_{OUT} = 30\text{ mA}$		100	200	mV
I_{OUT}	Output Current		100	160		mA
I_{GND}	Ground Current	$V_{IN} = 3.8\text{ V}$, $I_{OUT} = 30\text{ mA}$		1.5	3.5	mA
Line Reg	Line Regulation	$V_{IN} = 3.8\text{ to }13.8\text{ V}$		10	30	mV
Load Reg	Load Regulation	$I_{OUT} = 1\text{ to }60\text{ mA}$		20	40	mV
RR	Ripple Rejection	$C_L = 3.3\text{ }\mu\text{F}$, $f = 400\text{ Hz}$, $I_{OUT} = 10\text{ mA}$		63		dB
V_{ref}	Noise Bypass terminal Voltage			1.27		V
$\Delta V_{OUT}/\Delta T$	Temperature Coefficient			0.18		mV/ $^\circ\text{C}$

TK712xx

TK71230 ELECTRICAL CHARACTERISTICS

Test Conditions: $V_{IN} = 4.0\text{ V}$, $T_A = 25\text{ °C}$, unless otherwise specified.

SYMBOL	PARAMETER	TEST CONDITIONS	MIN	TYP	MAX	UNITS
I_Q	Quiescent Current	$V_{IN} = 4.0\text{ V}$, $I_{OUT} = 0\text{ mA}$		130	300	μA
		$V_{IN} = 2.5\text{ V}$, $I_{OUT} = 0\text{ mA}$		1.4	3.0	mA
V_{OUT}	Regulated Output Voltage	$V_{IN} = 4.0\text{ V}$, $I_{OUT} = 10\text{ mA}$	2.9	3.0	3.1	V
V_{DROP}	Dropout Voltage	$I_{OUT} = 30\text{ mA}$		100	200	mV
I_{OUT}	Output Current		100	160		mA
I_{GND}	Ground Current	$V_{IN} = 4.0\text{ V}$, $I_{OUT} = 30\text{ mA}$		1.5	3.5	mA
Line Reg	Line Regulation	$V_{IN} = 4.0\text{ to }14.0\text{ V}$		10	30	mV
Load Reg	Load Regulation	$I_{OUT} = 1\text{ to }60\text{ mA}$		20	40	mV
RR	Ripple Rejection	$C_L = 3.3\text{ }\mu\text{F}$, $f = 400\text{ Hz}$, $I_{OUT} = 10\text{ mA}$		63		dB
V_{ref}	Noise Bypass Terminal Voltage			1.27		V
$\Delta V_{OUT}/\Delta T$	Temperature Coefficient			0.18		mV/°C

TK71233 ELECTRICAL CHARACTERISTICS

Test Conditions: $V_{IN} = 3.9\text{ V}$, $T_A = 25\text{ °C}$, unless otherwise specified.

SYMBOL	PARAMETER	TEST CONDITIONS	MIN	TYP	MAX	UNITS
I_Q	Quiescent Current	$V_{IN} = 3.9\text{ V}$, $I_{OUT} = 0\text{ mA}$		130	300	μA
		$V_{IN} = 2.8\text{ V}$, $I_{OUT} = 0\text{ mA}$		1.4	3.0	mA
V_{OUT}	Regulated Output Voltage	$V_{IN} = 3.9\text{ V}$, $I_{OUT} = 10\text{ mA}$	3.2	3.3	3.4	V
V_{DROP}	Dropout Voltage	$I_{OUT} = 30\text{ mA}$		100	200	mV
I_{OUT}	Output Current		100	160		mA
I_{GND}	Ground Current	$V_{IN} = 3.9\text{ V}$, $I_{OUT} = 30\text{ mA}$		1.5	3.5	mA
Line Reg	Line Regulation	$V_{IN} = 3.9\text{ to }14.0\text{ V}$		10	30	mV
Load Reg	Load Regulation	$I_{OUT} = 1\text{ to }60\text{ mA}$		20	40	mV
RR	Ripple Rejection	$C_L = 3.3\text{ }\mu\text{F}$, $f = 400\text{ Hz}$, $I_{OUT} = 10\text{ mA}$		63		dB
V_{ref}	Noise Bypass Terminal Voltage			1.27		V
$\Delta V_{OUT}/\Delta T$	Temperature Coefficient			0.18		mV/°C

TK71235 ELECTRICAL CHARACTERISTICSTest Conditions: $V_{IN} = 4.1\text{ V}$, $T_A = 25\text{ }^\circ\text{C}$, unless otherwise specified.

SYMBOL	PARAMETER	TEST CONDITIONS	MIN	TYP	MAX	UNITS
I_Q	Quiescent Current	$V_{IN} = 4.1\text{ V}$, $I_{OUT} = 0\text{ mA}$		130	300	μA
		$V_{IN} = 3.0\text{ V}$, $I_{OUT} = 0\text{ mA}$		1.4	3.0	mA
V_{OUT}	Regulated Output Voltage	$V_{IN} = 4.1\text{ V}$, $I_{OUT} = 10\text{ mA}$	3.39	3.50	3.61	V
V_{DROD}	Dropout Voltage	$I_{OUT} = 30\text{ mA}$		100	200	mV
I_{OUT}	Output Current		100	160		mA
I_{GND}	Ground Current	$V_{IN} = 4.1\text{ V}$, $I_{OUT} = 30\text{ mA}$		1.5	3.5	mA
Line Reg	Line Regulation	$V_{IN} = 4.1\text{ to }14.0\text{ V}$		10	30	mV
Load Reg	Load Regulation	$I_{OUT} = 1\text{ to }60\text{ mA}$		20	40	mV
RR	Ripple Rejection	$C_L = 3.3\text{ }\mu\text{F}$, $f = 400\text{ Hz}$, $I_{OUT} = 10\text{ mA}$		63		dB
V_{ref}	Noise Bypass Terminal Voltage			1.27		V
$\Delta V_{OUT}/\Delta T$	Temperature Coefficient			0.2		mV/ $^\circ\text{C}$

TK71240 ELECTRICAL CHARACTERISTICSTest Conditions: $V_{IN} = 4.6\text{ V}$, $T_A = 25\text{ }^\circ\text{C}$, unless otherwise specified.

SYMBOL	PARAMETER	TEST CONDITIONS	MIN	TYP	MAX	UNITS
I_Q	Quiescent Current	$V_{IN} = 4.6\text{ V}$, $I_{OUT} = 0\text{ mA}$		130	300	μA
		$V_{IN} = 3.5\text{ V}$, $I_{OUT} = 0\text{ mA}$		1.4	3.0	mA
V_{OUT}	Regulated Output Voltage	$V_{IN} = 4.6\text{ V}$, $I_{OUT} = 10\text{ mA}$	3.88	4.00	4.12	V
V_{DROD}	Dropout Voltage	$I_{OUT} = 30\text{ mA}$		100	200	mV
I_{OUT}	Output Current		100	160		mA
I_{GND}	Ground Current	$V_{IN} = 4.6\text{ V}$, $I_{OUT} = 30\text{ mA}$		1.5	3.5	mA
Line Reg	Line Regulation	$V_{IN} = 4.6\text{ to }14.0\text{ V}$		10	30	mV
Load Reg	Load Regulation	$I_{OUT} = 1\text{ to }60\text{ mA}$		20	40	mV
RR	Ripple Rejection	$C_L = 3.3\text{ }\mu\text{F}$, $f = 400\text{ Hz}$, $I_{OUT} = 10\text{ mA}$		63		dB
V_{ref}	Noise Bypass Terminal Voltage			1.27		V
$\Delta V_{OUT}/\Delta T$	Temperature Coefficient			0.2		mV/ $^\circ\text{C}$

TK712xx

TK71245 ELECTRICAL CHARACTERISTICS

Test Conditions: $V_{IN} = 5.1 \text{ V}$, $T_A = 25 \text{ }^\circ\text{C}$, unless otherwise specified.

SYMBOL	PARAMETER	TEST CONDITIONS	MIN	TYP	MAX	UNITS
I_Q	Quiescent Current	$V_{IN} = 5.1 \text{ V}$, $I_{OUT} = 0 \text{ mA}$		130	300	μA
		$V_{IN} = 4.0 \text{ V}$, $I_{OUT} = 0 \text{ mA}$		1.4	3.0	mA
V_{OUT}	Regulated Output Voltage	$V_{IN} = 5.1 \text{ V}$, $I_{OUT} = 10 \text{ mA}$	4.36	4.50	4.64	V
V_{DROP}	Dropout Voltage	$I_{OUT} = 30 \text{ mA}$		100	200	mV
I_{OUT}	Output Current		100	160		mA
I_{GND}	Ground Current	$V_{IN} = 5.1 \text{ V}$, $I_{OUT} = 30 \text{ mA}$		1.5	3.5	mA
Line Reg	Line Regulation	$V_{IN} = 5.1 \text{ to } 14.0 \text{ V}$		10	30	mV
Load Reg	Load Regulation	$I_{OUT} = 1 \text{ to } 60 \text{ mA}$		20	40	mV
RR	Ripple Rejection	$C_L = 3.3 \mu\text{F}$, $f = 400 \text{ Hz}$, $I_{OUT} = 10 \text{ mA}$		63		dB
V_{ref}	Noise Bypass Terminal Voltage			1.27		V
$\Delta V_{OUT}/\Delta T$	Temperature Coefficient			0.25		mV/ $^\circ\text{C}$

TK71250 ELECTRICAL CHARACTERISTICS

Test Conditions: $V_{IN} = 5.6 \text{ V}$, $T_A = 25 \text{ }^\circ\text{C}$, unless otherwise specified.

SYMBOL	PARAMETER	TEST CONDITIONS	MIN	TYP	MAX	UNITS
I_Q	Quiescent Current	$V_{IN} = 5.6 \text{ V}$, $I_{OUT} = 0 \text{ mA}$		130	300	μA
		$V_{IN} = 4.0 \text{ V}$, $I_{OUT} = 0 \text{ mA}$		1.4	3.0	mA
V_{OUT}	Regulated Output Voltage	$V_{IN} = 5.6 \text{ V}$, $I_{OUT} = 10 \text{ mA}$	4.85	5.00	5.15	V
V_{DROP}	Dropout Voltage	$I_{OUT} = 30 \text{ mA}$		100	200	mV
I_{OUT}	Output Current		100	160		mA
I_{GND}	Ground Current	$V_{IN} = 5.6 \text{ V}$, $I_{OUT} = 30 \text{ mA}$		1.5	3.5	mA
Line Reg	Line Regulation	$V_{IN} = 5.6 \text{ to } 14.0 \text{ V}$		10	30	mV
Load Reg	Load Regulation	$I_{OUT} = 1 \text{ to } 60 \text{ mA}$		20	40	mV
RR	Ripple Rejection	$C_L = 3.3 \mu\text{F}$, $f = 400 \text{ Hz}$, $I_{OUT} = 10 \text{ mA}$		63		dB
V_{ref}	Noise Bypass Terminal Voltage			1.27		V
$\Delta V_{OUT}/\Delta T$	Temperature Coefficient			0.25		mV/ $^\circ\text{C}$

TEST CIRCUIT

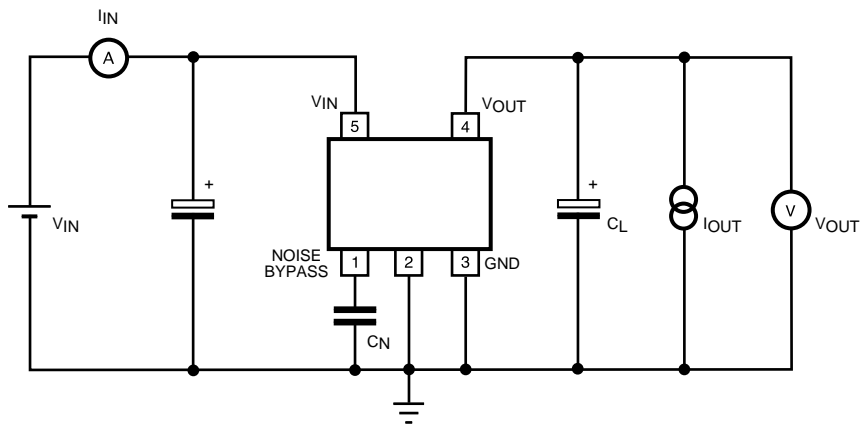

TYPICAL PERFORMANCE CHARACTERISTICS

$T_A = 25^\circ\text{C}$, unless otherwise specified.

OUTPUT VOLTAGE vs. INPUT VOLTAGE

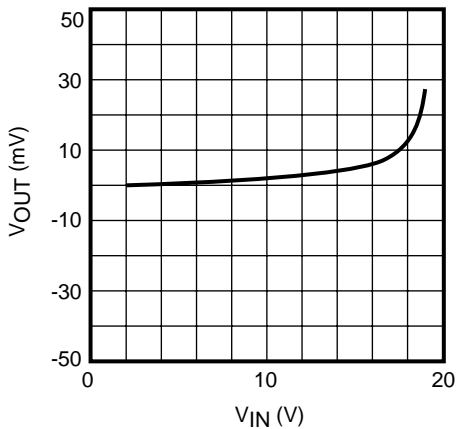

GROUND CURRENT vs. AMBIENT TEMPERATURE

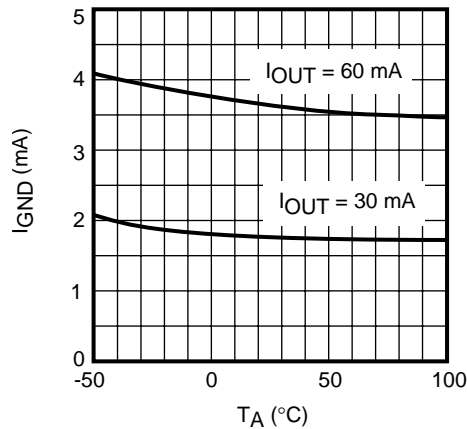

DROPOUT VOLTAGE vs. AMBIENT TEMPERATURE

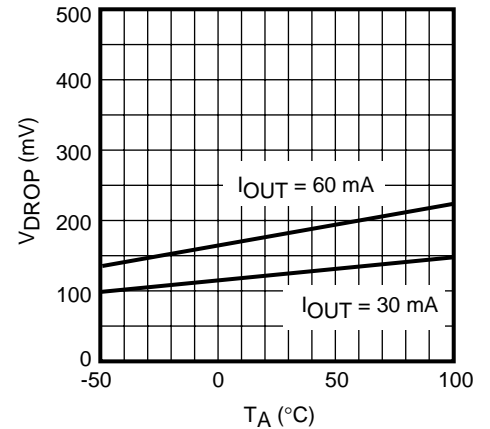

NOISE VOLTAGE vs. BYPASS CAPACITOR

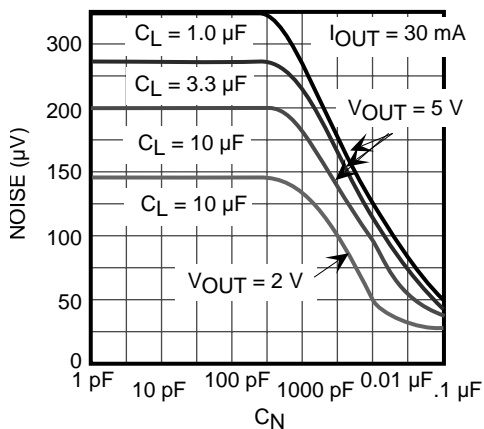

NOISE SPECTRUM

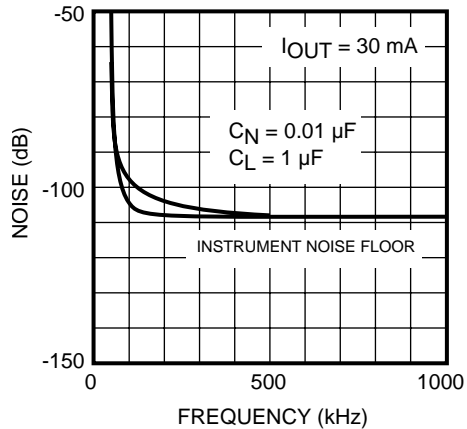

RIPPLE REJECTION vs. FREQUENCY

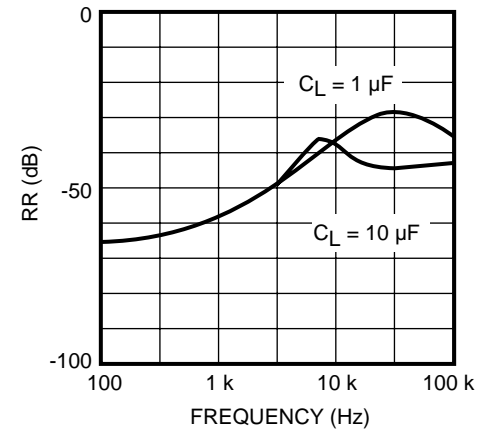

TYPICAL PERFORMANCE CHARACTERISTICS (CONT.)

$T_A = 25^\circ\text{C}$, unless otherwise specified.

LINE TRANSIENT RESPONSE

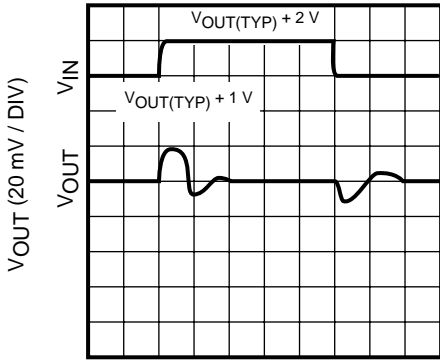

TIME (50 μs / DIV)

LOAD TRANSIENT RESPONSE

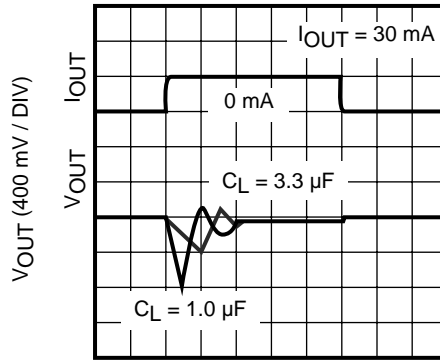

TIME (50 μs / DIV)

GROUND CURRENT vs. OUTPUT CURRENT

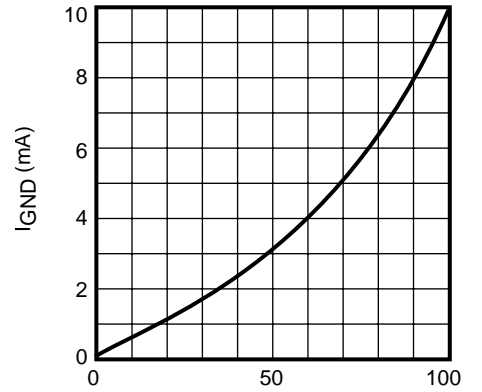

OUTPUT VOLTAGE vs. INPUT VOLTAGE

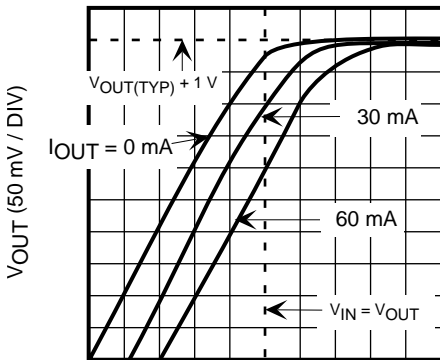

V_{IN} (100 mV / DIV)

TYPICAL PERFORMANCE CHARACTERISTICS (CONT.)

$T_A = 25^\circ\text{C}$, unless otherwise specified.

TK71220

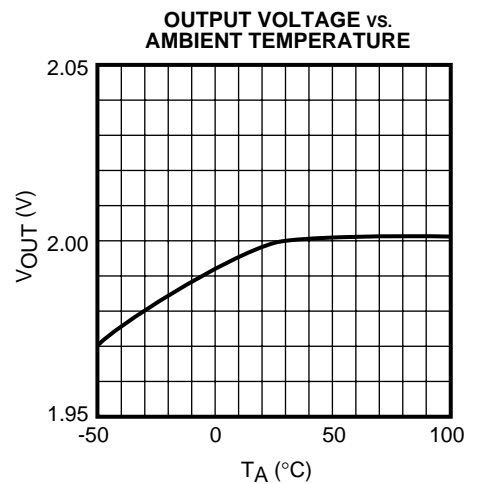
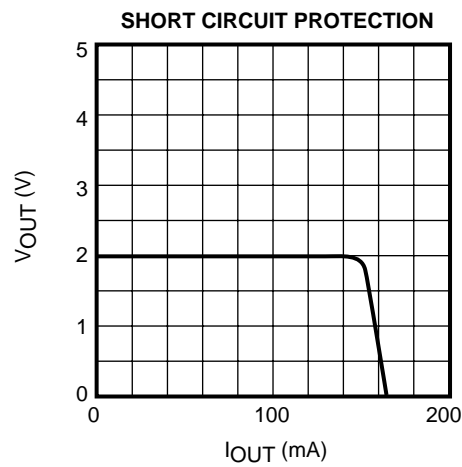
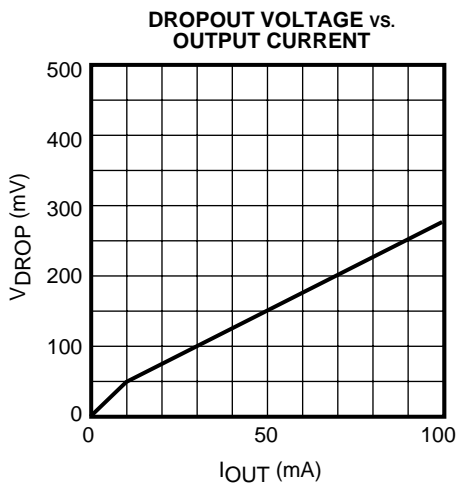
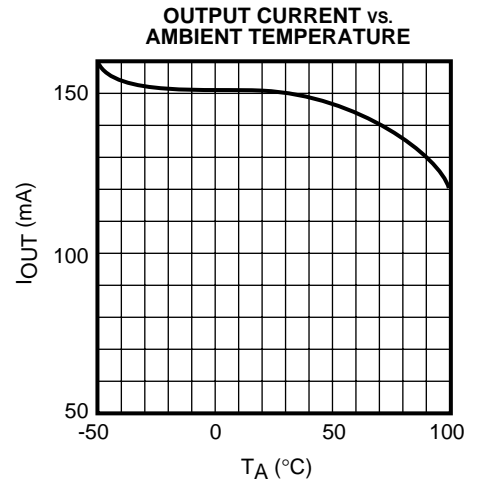
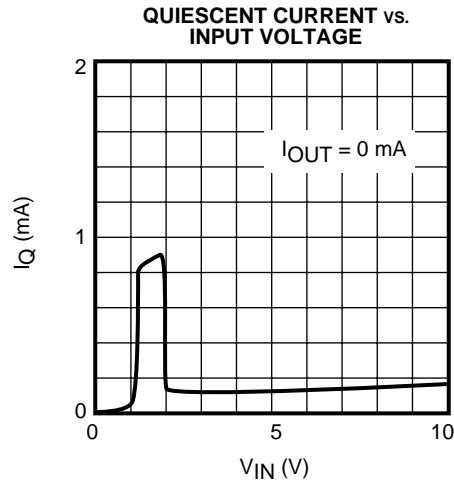
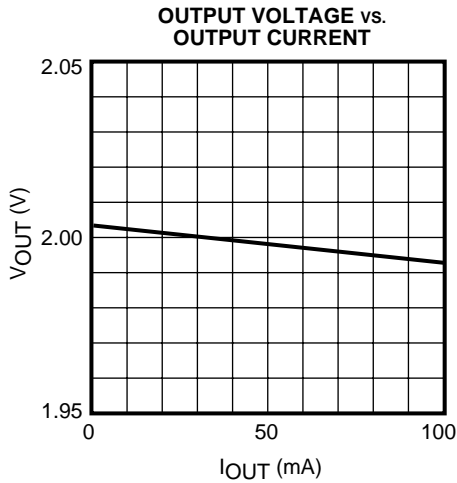

TK71225

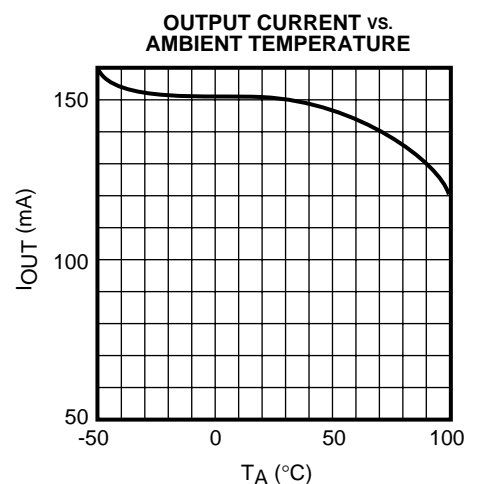
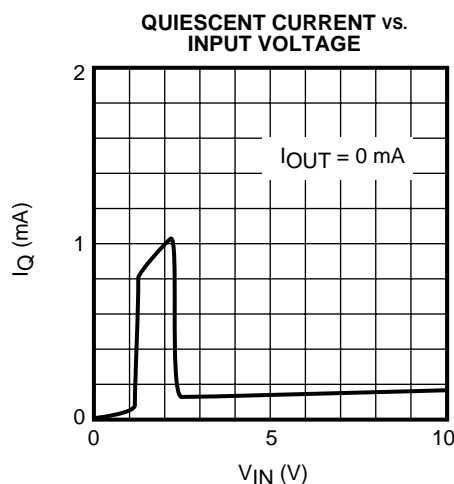
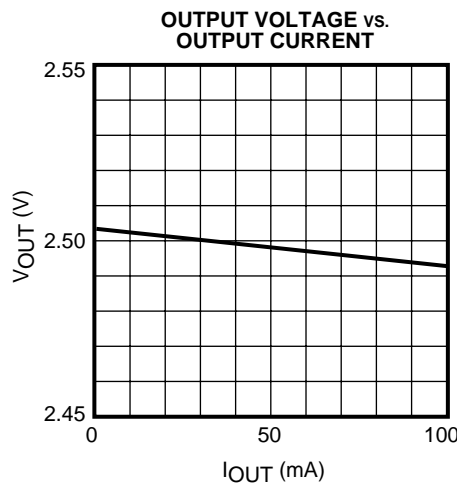

TYPICAL PERFORMANCE CHARACTERISTICS (CONT.)

$T_A = 25^\circ\text{C}$, unless otherwise specified.

TK71225 (CONT.)

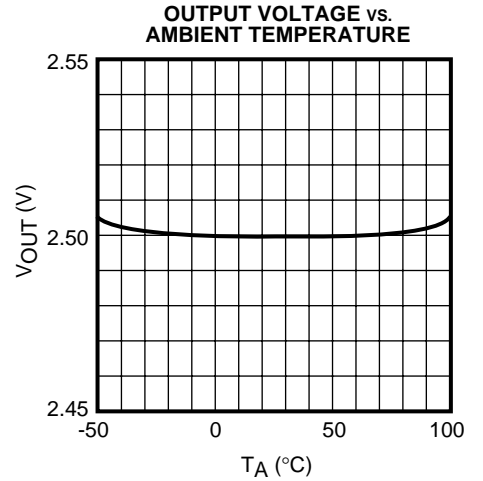
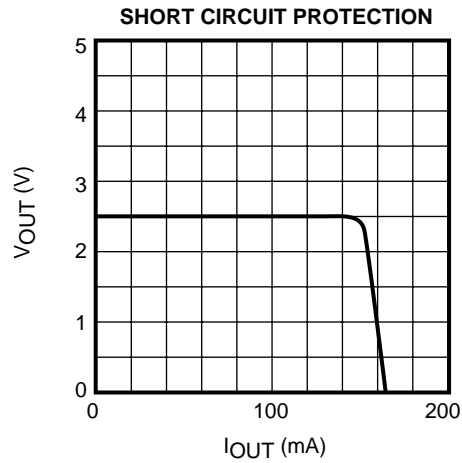
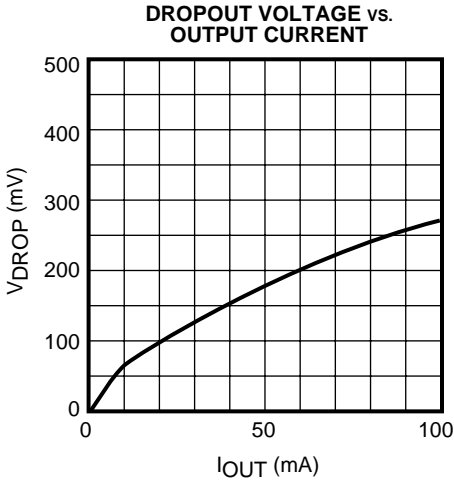

TK71228

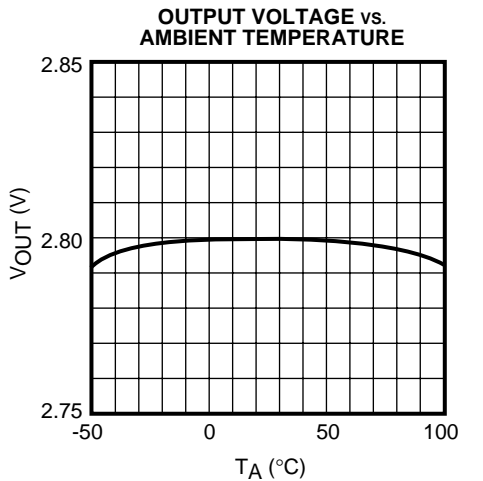
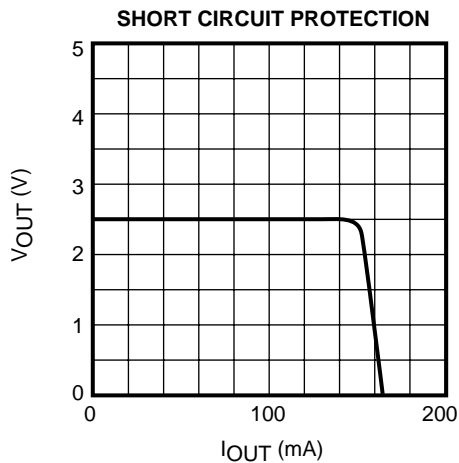
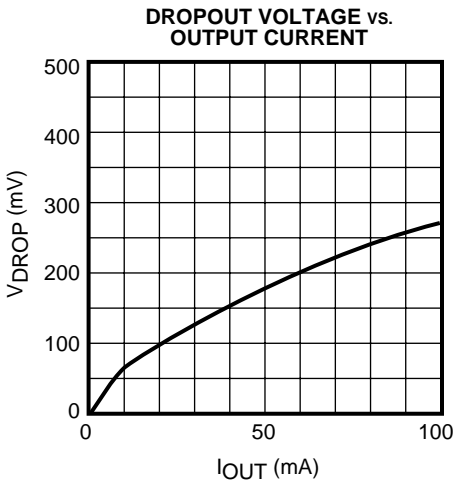
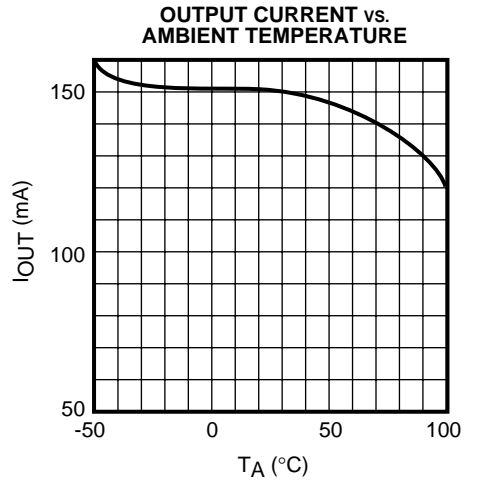
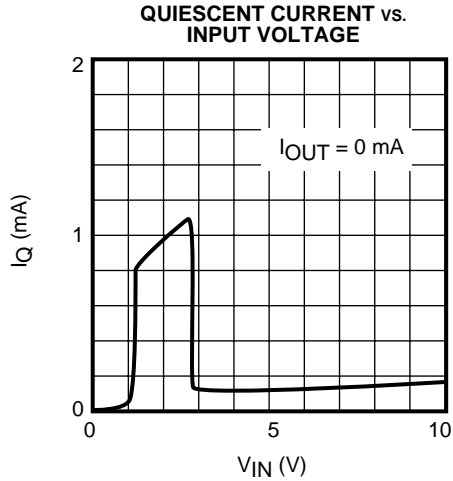
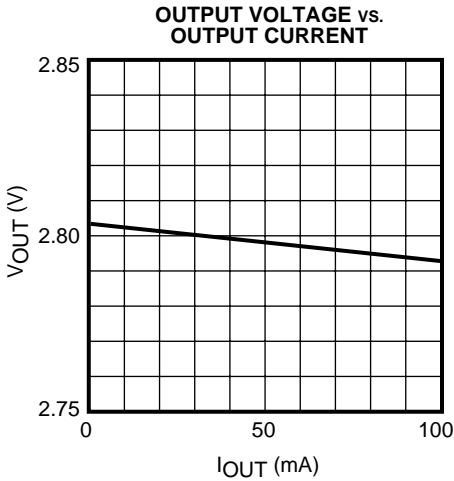

TYPICAL PERFORMANCE CHARACTERISTICS (CONT.)

$T_A = 25^\circ\text{C}$, unless otherwise specified.

TK71230

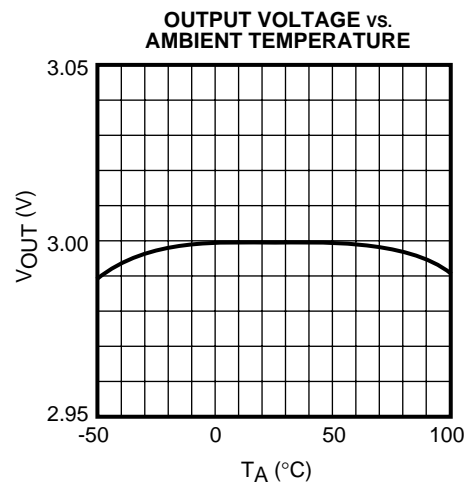
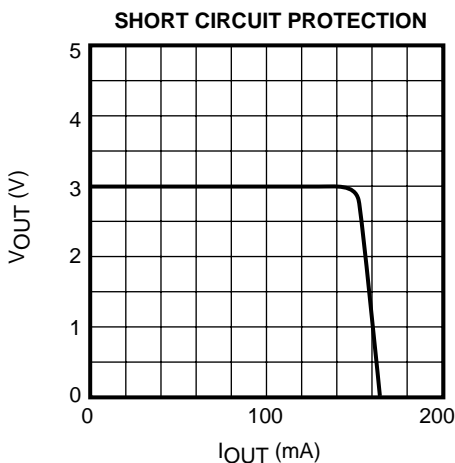
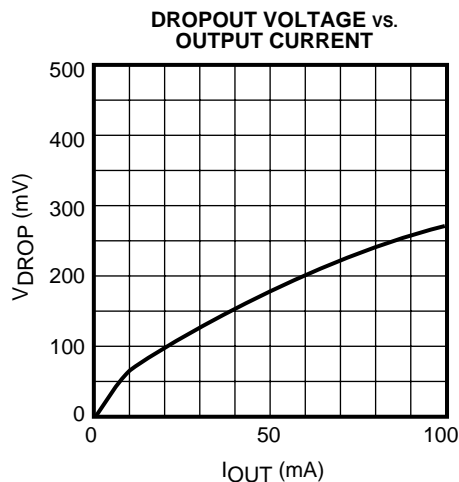
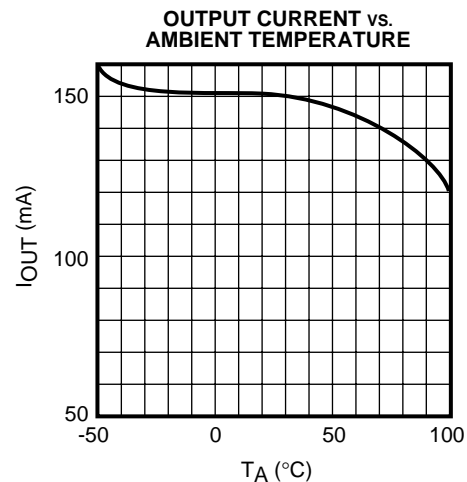
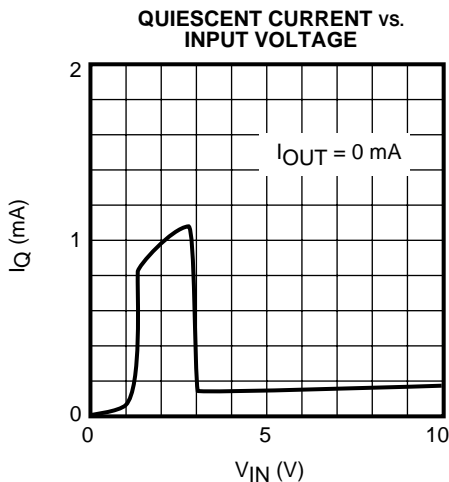
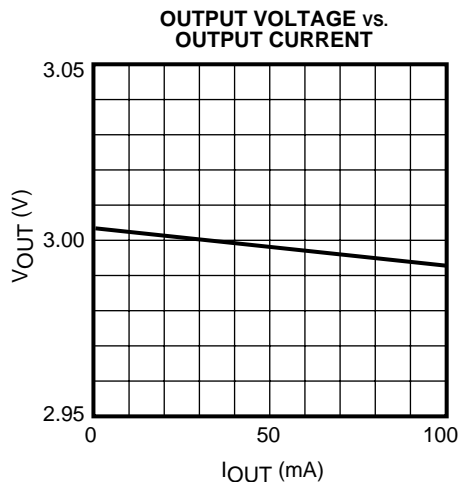

TK71233

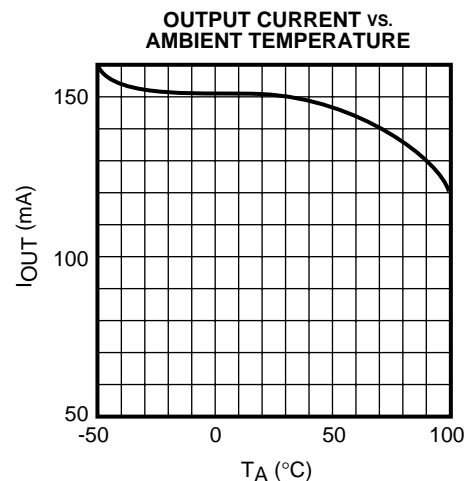
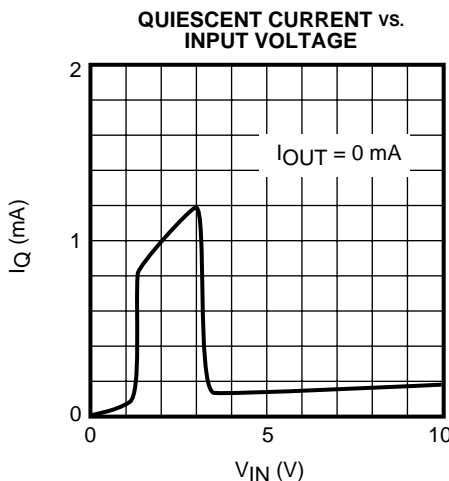
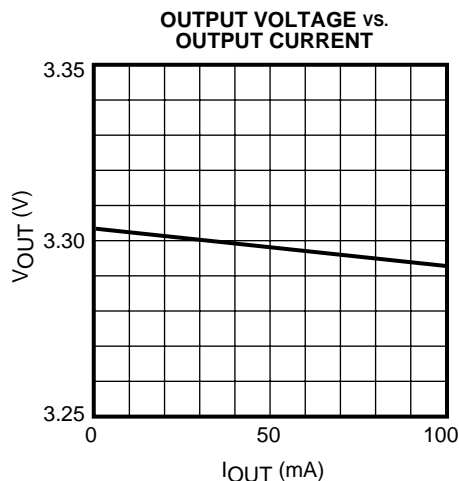

TYPICAL PERFORMANCE CHARACTERISTICS (CONT.)

$T_A = 25^\circ\text{C}$, unless otherwise specified.

TK71233 (CONT.)

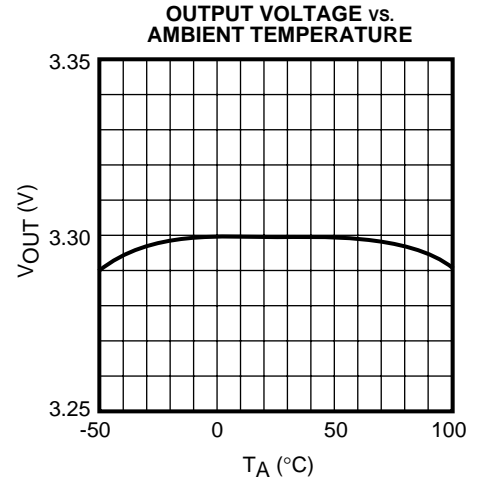
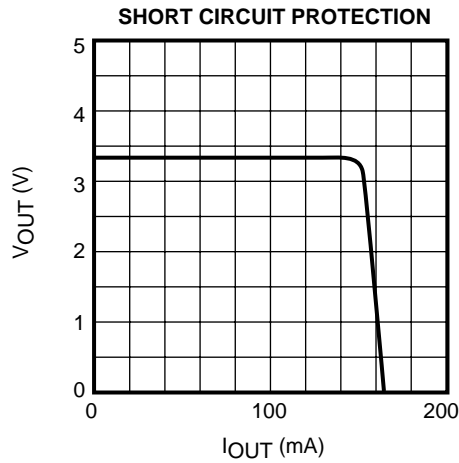
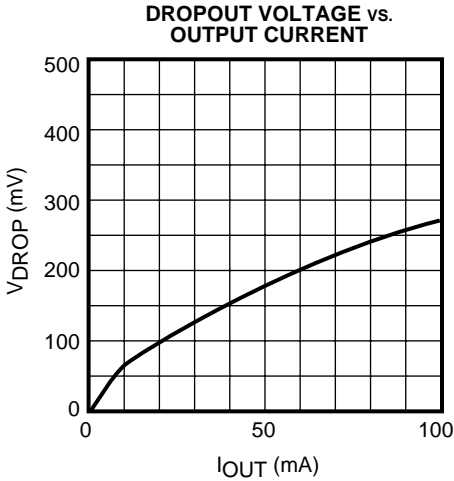

TK71235

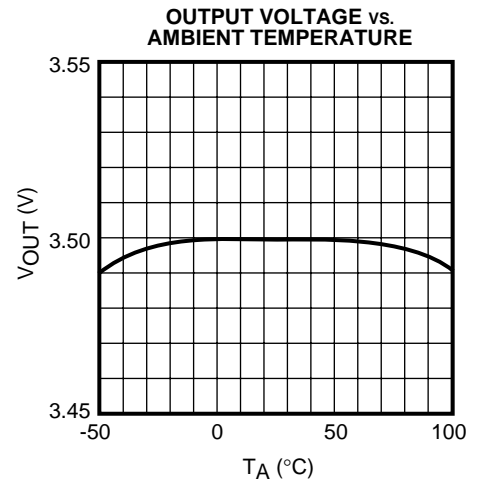
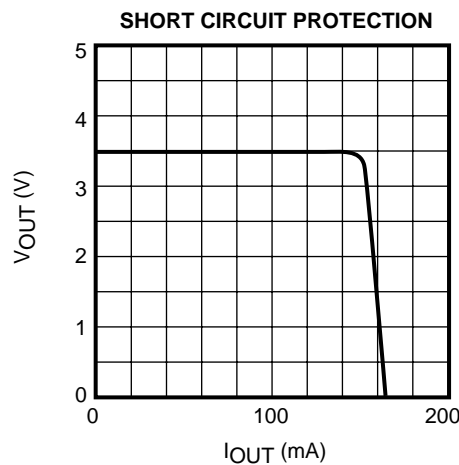
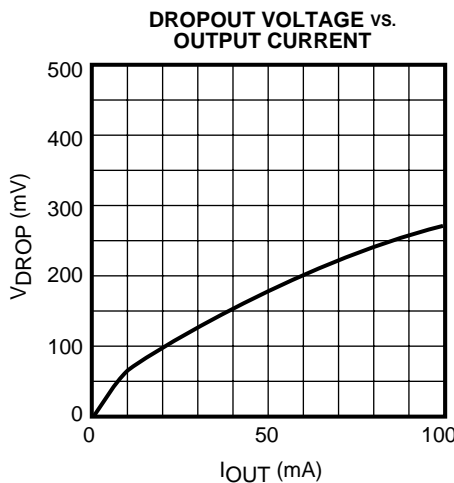
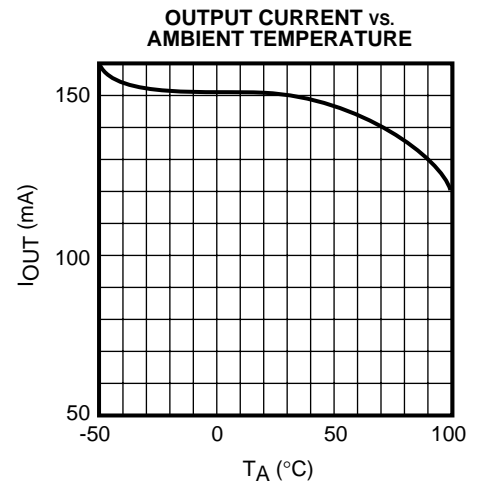
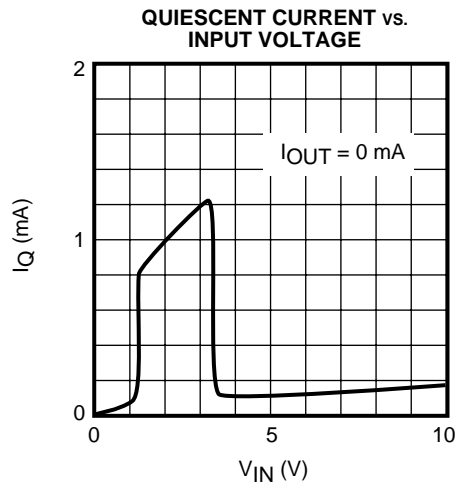
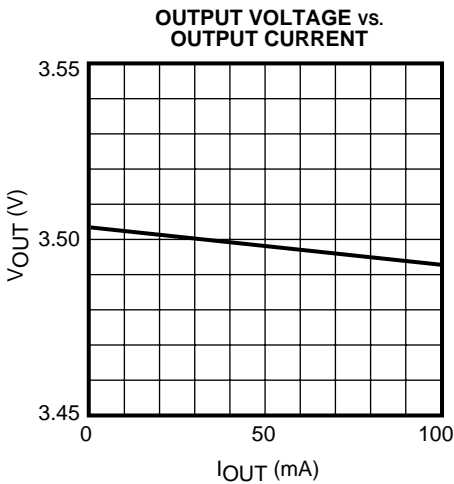

TYPICAL PERFORMANCE CHARACTERISTICS (CONT.)

$T_A = 25^\circ\text{C}$, unless otherwise specified.

TK71240

OUTPUT VOLTAGE vs. OUTPUT CURRENT

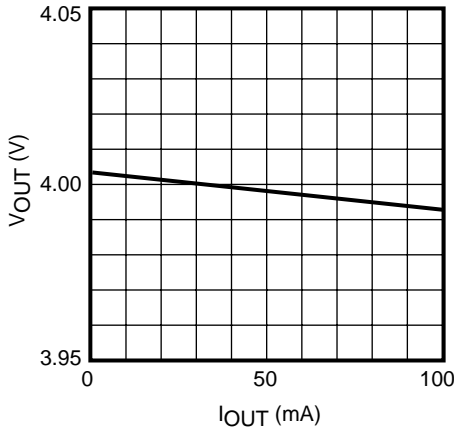

QUIESCENT CURRENT vs. INPUT VOLTAGE

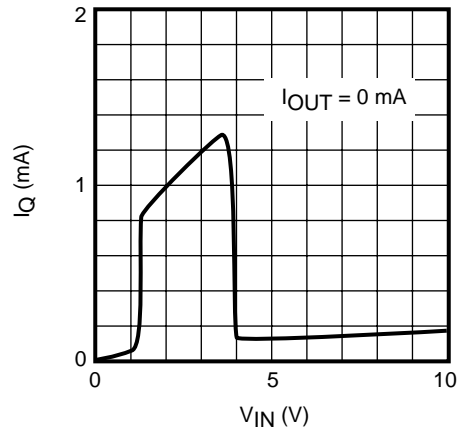

OUTPUT CURRENT vs. AMBIENT TEMPERATURE

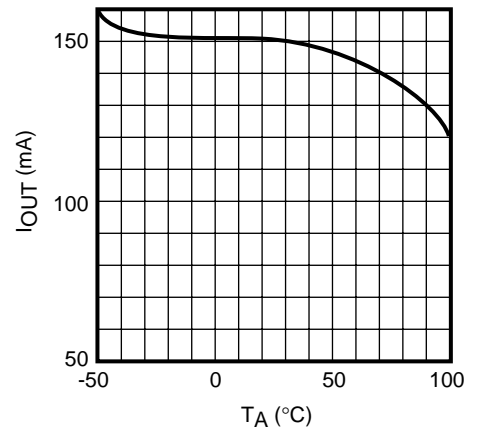

DROPOUT VOLTAGE vs. OUTPUT CURRENT

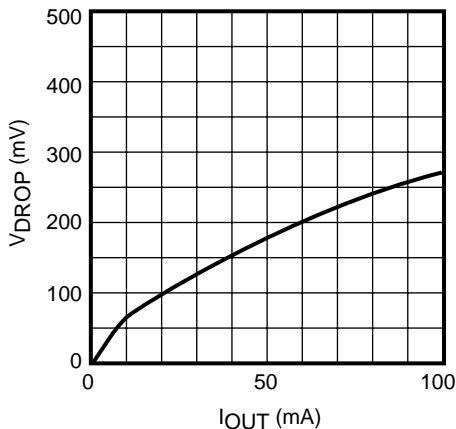

SHORT CIRCUIT PROTECTION

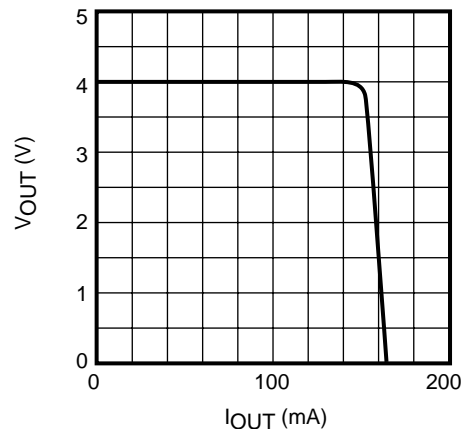

OUTPUT VOLTAGE vs. AMBIENT TEMPERATURE

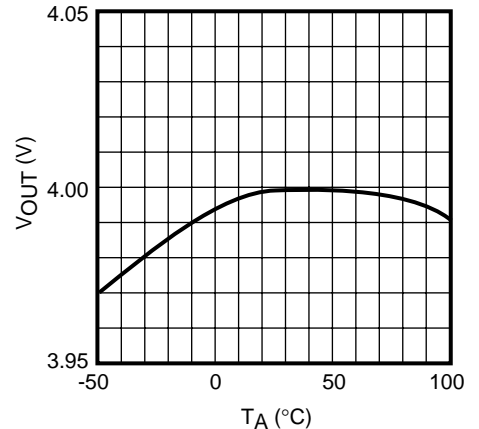

TK71245

OUTPUT VOLTAGE vs. OUTPUT CURRENT

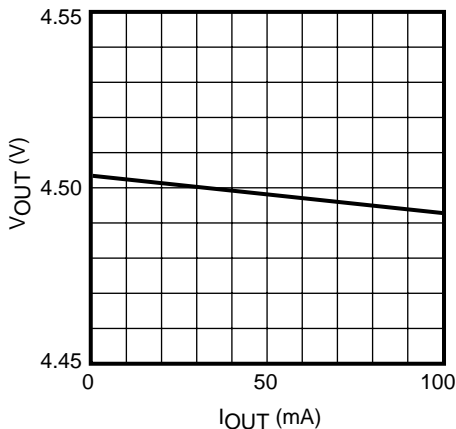

QUIESCENT CURRENT vs. INPUT VOLTAGE

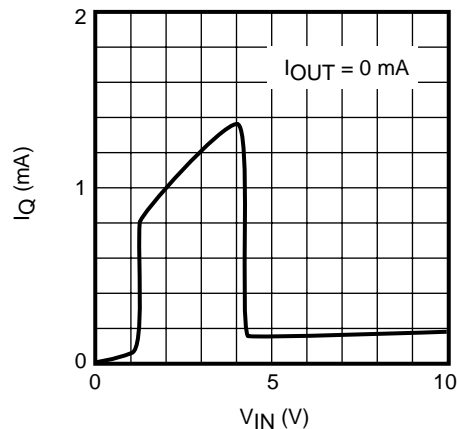

OUTPUT CURRENT vs. AMBIENT TEMPERATURE

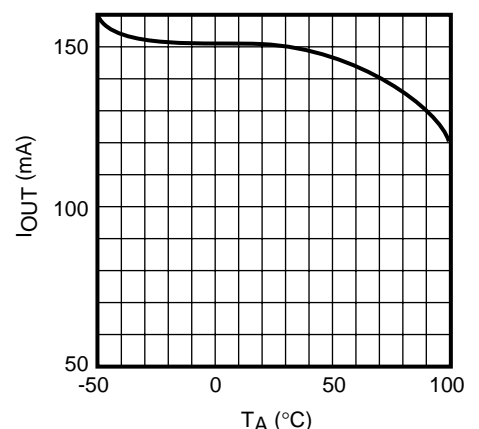

TYPICAL PERFORMANCE CHARACTERISTICS (CONT.)

$T_A = 25^\circ\text{C}$, unless otherwise specified.

TK71245 (CONT.)

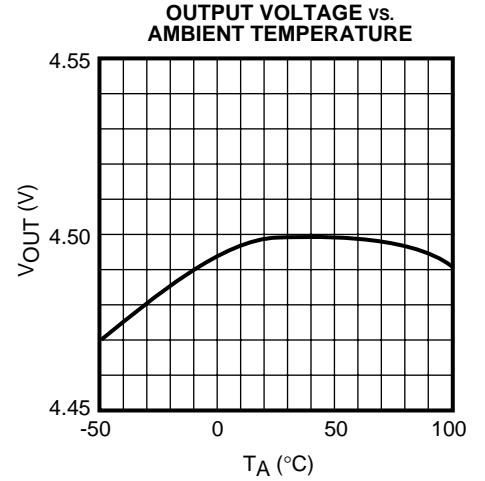
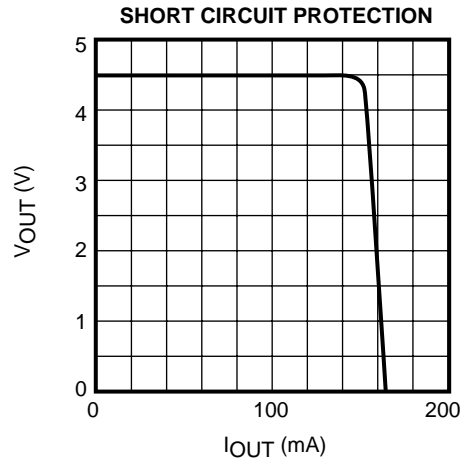
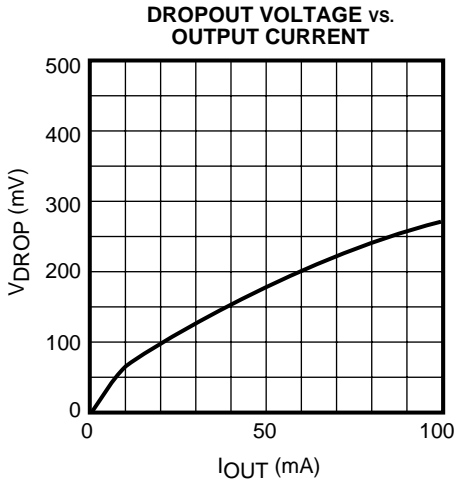

TK71250

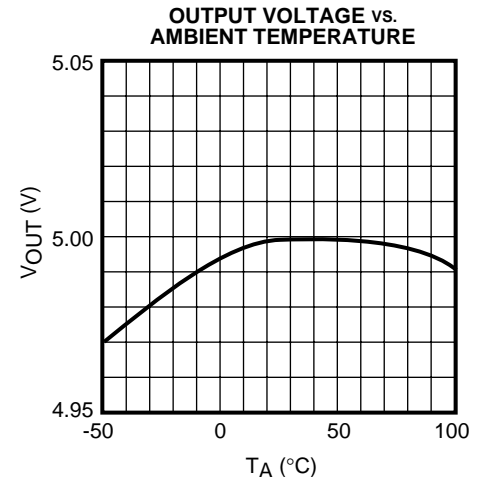
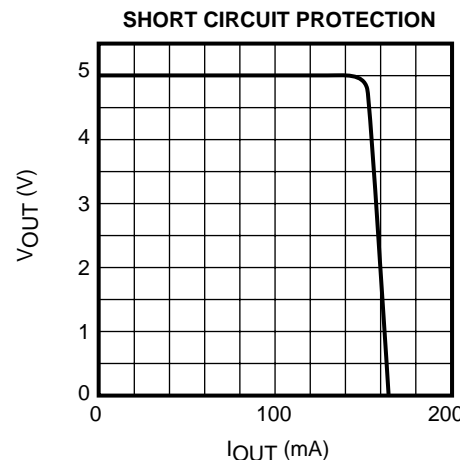
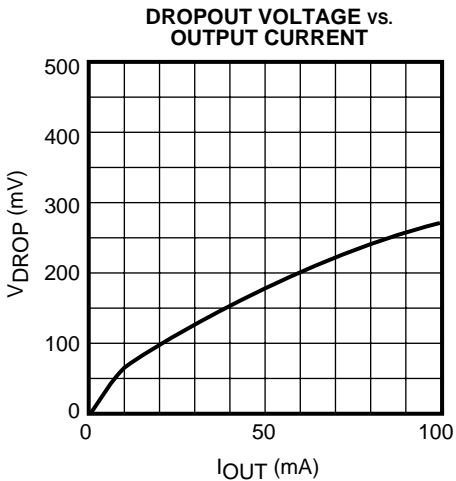
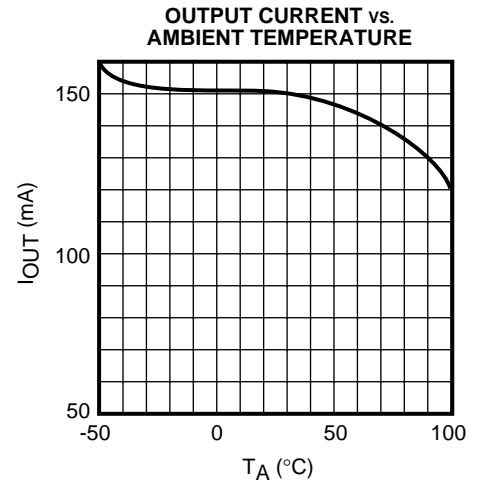
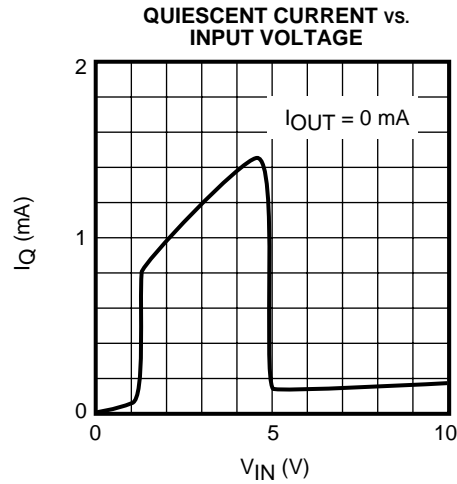
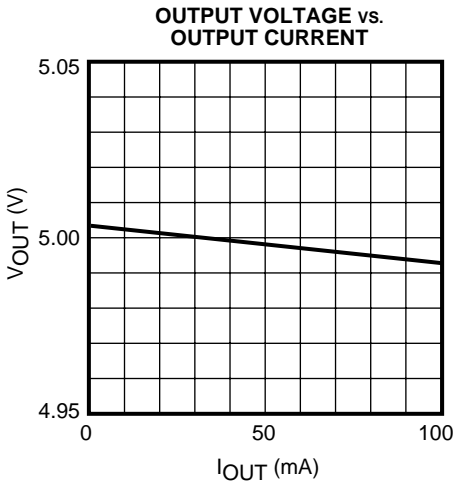

DEFINITION AND EXPLANATION OF TECHNICAL TERMS

LINE REGULATION (LINE REG)

Line regulation is the ability of the regulator to maintain a constant output voltage as the input voltage changes.

LOAD REGULATION (LOAD REG)

Load regulation is the ability of the regulator to maintain a constant output voltage as the load current changes. It is a pulsed measurement to minimize temperature effects. The load regulation is specified an output current step condition of 1 mA to 60 mA.

QUIESCENT CURRENT (I_Q)

The quiescent current is the current which flows through the ground terminal under no load conditions ($I_{OUT} = 0$ mA).

GROUND CURRENT (I_{GND})

Ground current is the current which flows through the ground pin(s). It is defined as $I_{IN} - I_{OUT}$, excluding I_{CONT} .

DROPOUT VOLTAGE (V_{DROP})

This is a measure of how well the regulator performs as the input voltage decreases. The smaller the number, the further the input voltage can decrease before regulation problems occur. Nominal output voltage is first measured when $V_{IN} = V_{OUT} + 1$ at a chosen load current. When the output voltage has dropped 100 mV from the nominal, $V_{IN} - V_O$ is the dropout voltage. This voltage is affected by load current and junction temperature.

OUTPUT NOISE VOLTAGE

This is the effective AC voltage that occurs on the output voltage under the condition where the input noise is low and with a given load, filter capacitor, and frequency range.

THERMAL PROTECTION

This is an internal feature which turns the regulator off when the junction temperature rises above 150 °C. After the regulator turns off, the temperature drops and the regulator output turns back on. Under certain conditions, the output waveform may appear to be an oscillation as the output turns off and on and back again in succession.

PACKAGE POWER DISSIPATION (P_D)

This is the power dissipation level at which the thermal sensor is activated. The IC contains an internal thermal sensor which monitors the junction temperature. When the junction temperature exceeds the monitor threshold of 150 °C, the IC is shut down. The junction temperature rises as the difference between the input power ($V_{IN} \times I_{IN}$) and the output power ($V_{OUT} \times I_{OUT}$) increases. The rate of temperature rise is greatly affected by the mounting pad configuration on the PCB, the board material, and the ambient temperature. When the IC mounting has good thermal conductivity, the junction temperature will be low even if the power dissipation is great. When mounted on the mounting pad, the power dissipation of the SOT-25 is increased to 350 mW. For operation at ambient temperatures over 25 °C, the power dissipation of the SOT-25 device should be derated at 2.8 mW/°C. To determine the power dissipation for shutdown when mounted, attach the device on the actual PCB and deliberately increase the output current (or raise the input voltage) until the thermal protection circuit is activated. Calculate the power dissipation of the device by subtracting the output power from the input power. These measurements should allow for the ambient temperature of the PCB. The value obtained from $P_D / (150\text{ °C} - T_A)$ is the derating factor. The PCB mounting pad should provide maximum thermal conductivity in order to maintain low device temperatures. As a general rule, the lower the temperature, the better the reliability of the device. The thermal resistance when mounted is expressed as follows:

$$T_j = \theta_{jA} \times P_D + T_A$$

For Toko ICs, the internal limit for junction temperature is 150 °C. If the ambient temperature (T_A) is 25 °C, then:

$$150\text{ °C} = \theta_{jA} \times P_D + 25\text{ °C}$$

$$\theta_{jA} = 125\text{ °C} / P_D$$

P_D is the value when the thermal sensor is activated. A simple way to determine P_D is to calculate $V_{IN} \times I_{IN}$ when the output side is shorted. Input current gradually falls as temperature rises. You should use the value when thermal equilibrium is reached.

DEFINITION AND EXPLANATION OF TECHNICAL TERMS (CONT.)

The range of usable currents can also be found from the graph below.

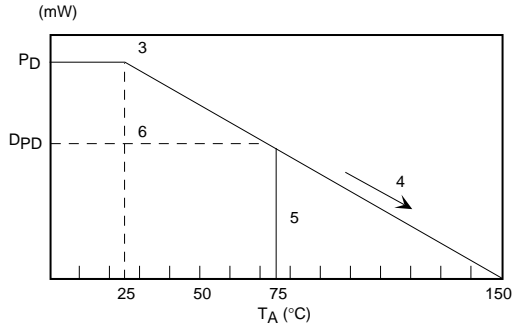

Procedure:

- 1) Find P_D
- 2) P_{D1} is taken to be $P_D \times (\sim 0.8 - 0.9)$
- 3) Plot P_{D1} against 25°C
- 4) Connect P_{D1} to the point corresponding to the 150°C with a straight line.
- 5) In design, take a vertical line from the maximum operating temperature (e.g., 75°C) to the derating curve.
- 6) Read off the value of P_D against the point at which the vertical line intersects the derating curve. This is taken as the maximum power dissipation, D_{PD} .

The maximum operating current is:

$$I_{\text{OUT}} = (D_{PD} / (V_{\text{IN(MAX)}} - V_{\text{OUT}}))$$

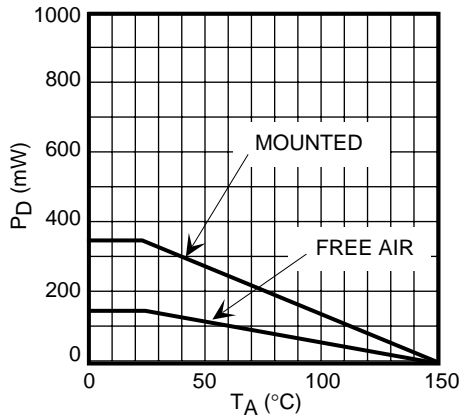

SOT-25 POWER DISSIPATION CURVE

APPLICATION INFORMATION

INPUT/OUTPUT DECOUPLING CAPACITOR CONSIDERATIONS

Voltage regulators require input and output decoupling capacitors. The required value of these capacitors vary with application. Capacitors made by different manufacturers can have different characteristics, particularly with regard to high frequencies and Equivalent Series Resistance (ESR) over temperature. The type of capacitor is also important. For example, a 4.7 μF aluminum electrolytic may be required for a certain application. If a tantalum capacitor is used, a lower value of 2.2 μF would be adequate. It is important to consider the temperature characteristics of the decoupling capacitors. While Toko regulators are designed to operate as low as $-40\text{ }^{\circ}\text{C}$, many capacitors will not operate properly at this temperature. The capacitance of aluminum electrolytic capacitors may decrease to 0 at low temperatures. This may cause oscillation on the output of the regulator since some capacitance is required to guarantee stability. Thus, it is important to consider the characteristics of the capacitor over temperature when selecting decoupling capacitors.

The ESR is another important parameter. The ESR will increase with temperature but low ESR capacitors are often larger and more costly. In general, tantalum capacitors offer lower ESR than aluminum electrolytic, but new low ESR aluminum electrolytic capacitors are now available from several manufacturers. Usually a bench test is sufficient to determine the minimum capacitance required for a particular application. After taking thermal characteristics and tolerance into account, the minimum capacitance value should be approximately two times this value. The recommended minimum capacitance for the TK712xx is 2.2 μF for a tantalum capacitor or 3.3 μF for an aluminum electrolytic. Please note that linear regulators with a low dropout voltage have high internal loop gains which require care in guarding against oscillation caused by insufficient decoupling capacitance. The use of high quality decoupling capacitors suited for your application will guarantee proper operation of the circuit. Pay attention to temperature characteristics of the capacitor, especially the increase of ESR and decrease of capacitance in low temperatures. Oscillation, reduction of ripple rejection and increased noise may occur in some cases if the proper capacitor is not used. An output capacitor more than 1.0 μF is required to maintain stability. The standard test condition is 3.3 μF ($T_A = 25\text{ }^{\circ}\text{C}$).

OPTIMUM PERFORMANCE

Optimum performance can only be achieved when the IC is mounted on a PC board according to the diagram below. This is because of the extremely small package and limited power dissipation. Shape the metal portion of the PCB as shown in the following drawing.

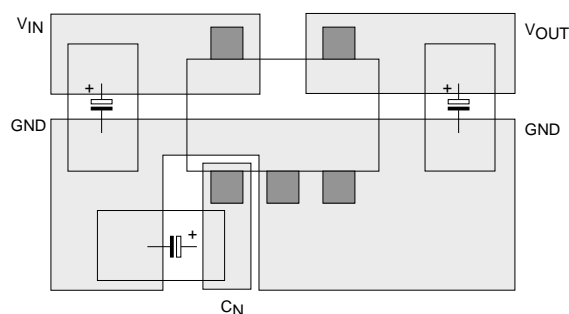

SOT-25 BOARD LAYOUT

Use a large bypass capacitor and connect it in a place near GND of the IC. Pay attention to temperature characteristics of the capacitor, especially the increase of ESR and decrease of capacitance in low temperatures. Oscillation, reduction of ripple rejection and increased noise may occur in some cases if the proper capacitor is not used. An output capacitor more than 1.0 μF is required to maintain stability. The standard test condition is 3.3 μF ($T_A = 25\text{ }^{\circ}\text{C}$).

PACKAGE OUTLINE

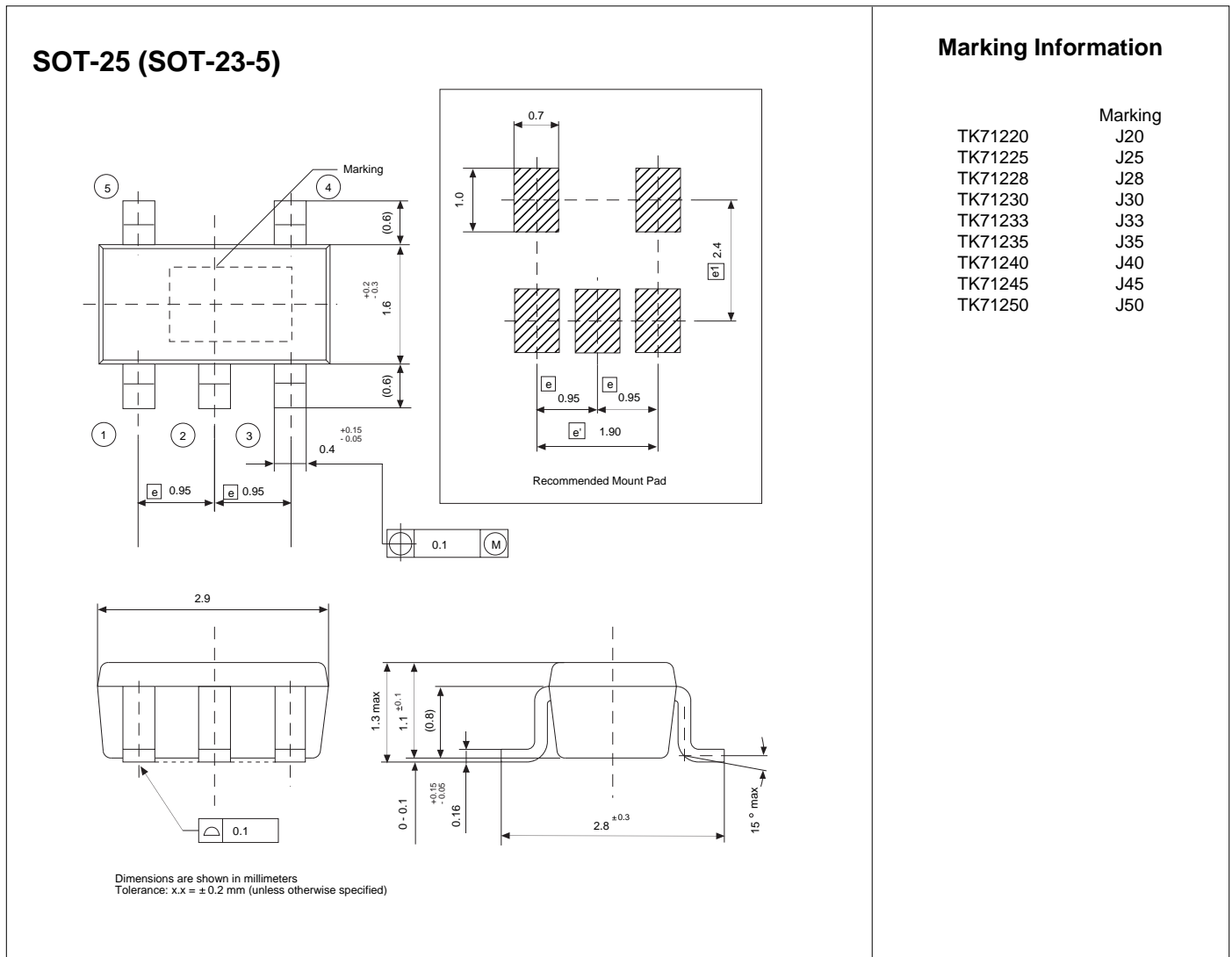

Toko America, Inc. Headquarters
 1250 Feehanville Drive, Mount Prospect, Illinois 60056
 Tel: (847) 297-0070 Fax: (847) 699-7864

TOKO AMERICA REGIONAL OFFICES

Midwest Regional Office
 Toko America, Inc.
 1250 Feehanville Drive
 Mount Prospect, IL 60056
 Tel: (847) 297-0070
 Fax: (847) 699-7864

Western Regional Office
 Toko America, Inc.
 2480 North First Street, Suite 260
 San Jose, CA 95131
 Tel: (408) 432-8281
 Fax: (408) 943-9790

Eastern Regional Office
 Toko America, Inc.
 107 Mill Plain Road
 Danbury, CT 06811
 Tel: (203) 748-6871
 Fax: (203) 797-1223

Semiconductor Technical Support
 Toko Design Center
 4755 Forge Road
 Colorado Springs, CO 80907
 Tel: (719) 528-2200
 Fax: (719) 528-2375

Visit our Internet site at <http://www.tokoam.com>

The information furnished by TOKO, Inc. is believed to be accurate and reliable. However, TOKO reserves the right to make changes or improvements in the design, specification or manufacture of its products without further notice. TOKO does not assume any liability arising from the application or use of any product or circuit described herein, nor for any infringements of patents or other rights of third parties which may result from the use of its products. No license is granted by implication or otherwise under any patent or patent rights of TOKO, Inc.