

N-Channel Enhancement Mode MOSFET

Features

- 30V/3.5A, $R_{DS(ON)}=70m\Omega(\text{typ.}) @ V_{GS}=5V$
 $R_{DS(ON)}=42m\Omega(\text{typ.}) @ V_{GS}=10V$
- Super High Dense Cell Design
- High Power and Current Handling Capability
- SOT-23 Package

Pin Description

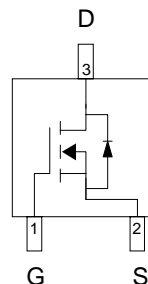

Top View of SOT-23

Applications

- Switching Regulators
- Switching Converters

Ordering and Marking Information

<p>APM2306 □□-□□</p> <div style="margin-left: 20px;"> <p>└─ Handling Code</p> <p>└─ Temp. Range</p> <p>└─ Package Code</p> </div>	<p>Package Code A : SOT-23 Operating Junction Temp. Range C : -55 to 150°C Handling Code TR : Tape & Reel</p>
<p>APM2306 A : M06X</p>	<p style="text-align: right;">X - Date Code</p>

Absolute Maximum Ratings ($T_A = 25^\circ\text{C}$ unless otherwise noted)

Symbol	Parameter	Rating	Unit	
V_{DSS}	Drain-Source Voltage	30	V	
V_{GSS}	Gate-Source Voltage	± 20		
I_D	Maximum Pulsed Drain Current (pulse width $\leq 300\mu\text{s}$)	3.5	A	
I_{DM}	Maximum Drain Current – Pulsed	16		
P_D	Maximum Power Dissipation	$T_A=25^\circ\text{C}$	1.25	W
		$T_A=100^\circ\text{C}$	0.5	W
T_J	Maximum Junction Temperature	150	$^\circ\text{C}$	
T_{STG}	Storage Temperature Range	-55 to 150	$^\circ\text{C}$	

ANPEC reserves the right to make changes to improve reliability or manufacturability without notice, and advise customers to obtain the latest version of relevant information to verify before placing orders.

Electrical Characteristics ($T_A = 25^\circ\text{C}$ unless otherwise noted)

Symbol	Parameter	Test Condition	APM2306			Unit
			Min.	Typ.	Max.	
Static						
BV_{DSS}	Drain-Source Breakdown Voltage	$V_{GS}=0V, I_{DS}=250\mu A$	30			V
I_{DSS}	Zero Gate Voltage Drain Current	$V_{DS}=24V, V_{GS}=0V$			1	μA
$V_{GS(th)}$	Gate Threshold Voltage	$V_{DS}=V_{GS}, I_{DS}=250\mu A$	1	1.5		V
I_{GSS}	Gate Leakage Current	$V_{GS}=\pm 20V, V_{DS}=0V$			± 100	nA
$R_{DS(on)}$	Drain-Source On-state Resistance	$V_{GS}=5V, I_{DS}=2.8A$		70	90	m Ω
		$V_{GS}=10V, I_{DS}=3.5A$		42	65	
V_{SD}	Diode Forward Voltage	$I_{SD}=1.25A, V_{GS}=0V$		1.1	1.5	V
Dynamic						
Q_g	Total Gate Charge	$V_{DS}=15V, V_{GS}=5V,$ $I_D=3.5A$		12.5		nC
Q_{gs}	Gate-Source Charge			3.7		nC
Q_{gd}	Gate-Drain Charge			2.4		nC
$t_{d(ON)}$	Turn-on Delay Time	$V_{DD}=15V, I_D=1A,$ $V_{GS}=10V, R_G=6\Omega$		10		ns
t_r	Turn-on Rise Time			8		ns
$t_{d(OFF)}$	Turn-off Delay Time			19		ns
t_f	Turn-off Fall Time			6.2		ns
C_{iss}	Input Capacitance	$V_{GS}=0V$		410		pF
C_{oss}	Output Capacitance	$V_{DS}=15V$		80		pF
C_{rss}	Reverse Transfer Capacitance	Frequency=1.0MHz		45		pF

Typical Characteristics

Output Characteristics

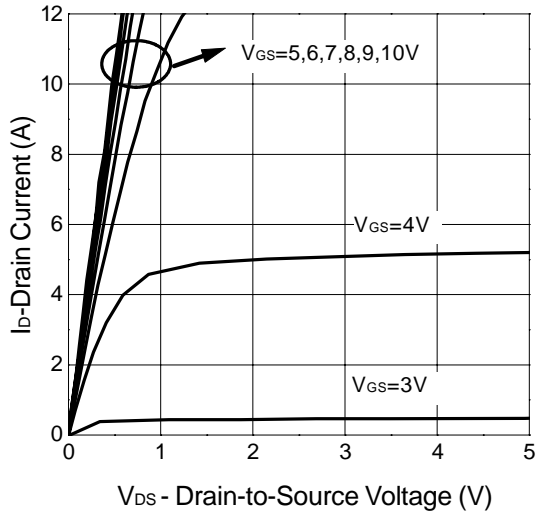

Transfer Characteristics

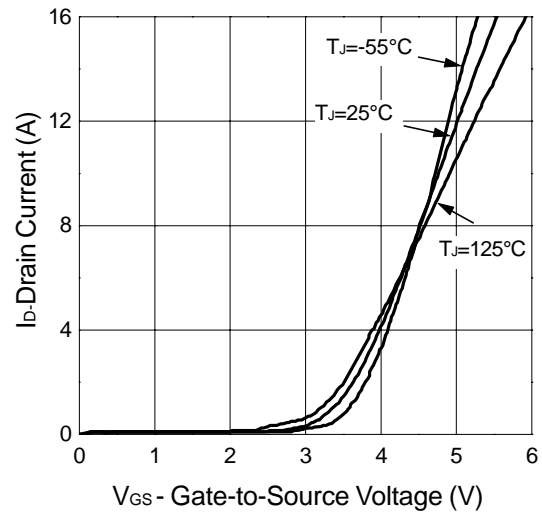

Threshold Voltage vs. Temperature

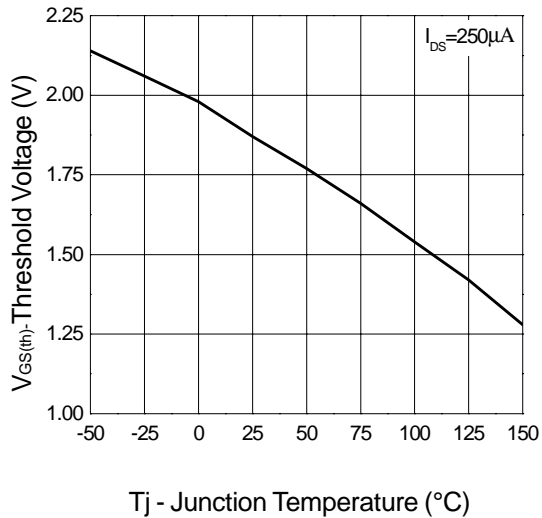

On-Resistance vs. Drain Current

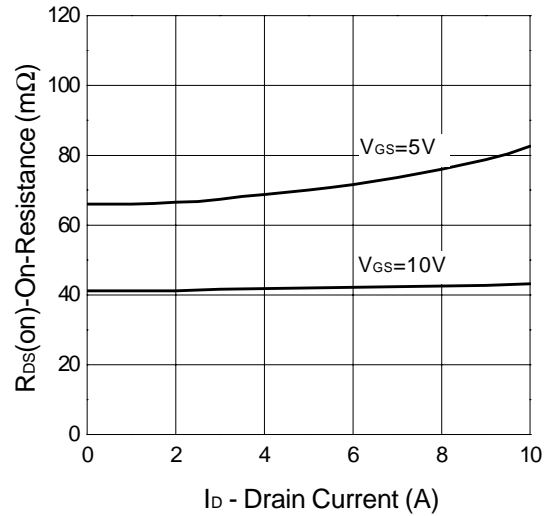

Typical Characteristics

On-Resistance vs. Gate-to-Source Voltage

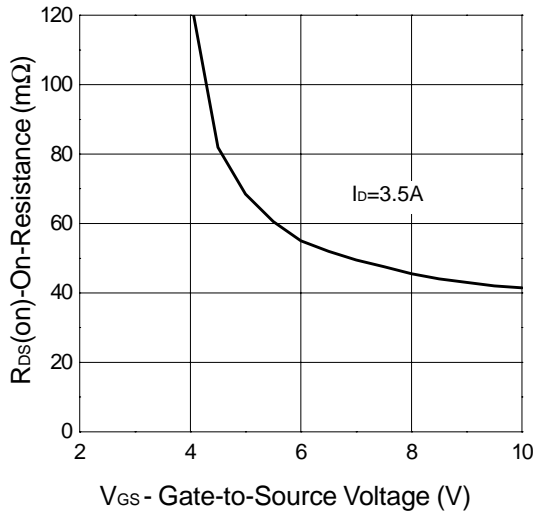

On-Resistance vs. Junction Temperature

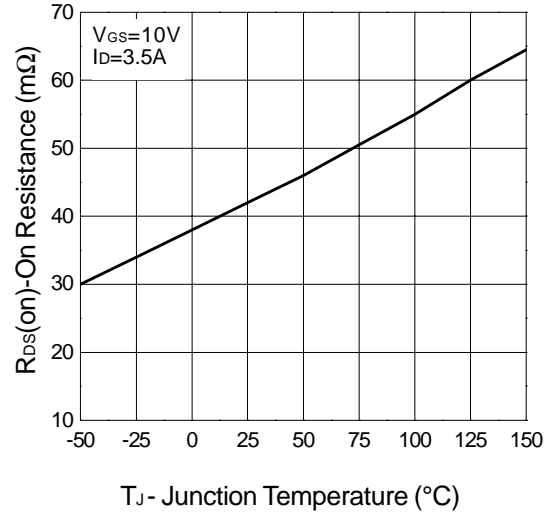

Gate Charge

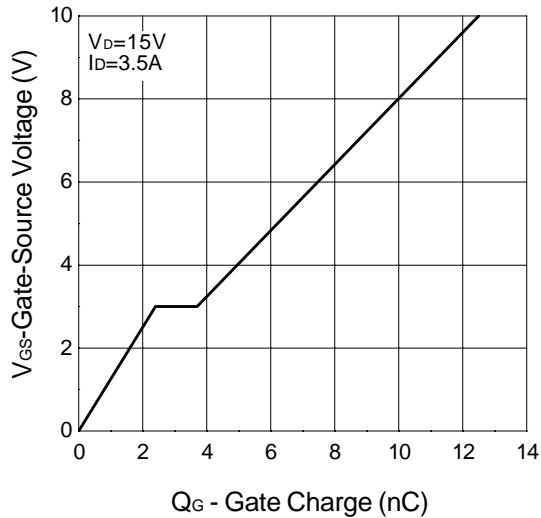

Capacitance

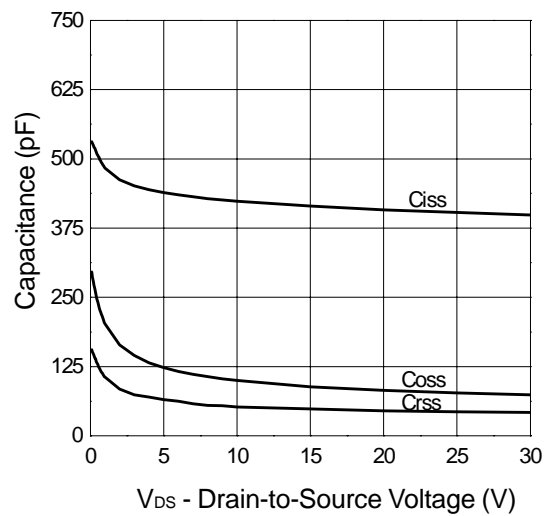

Typical Characteristics

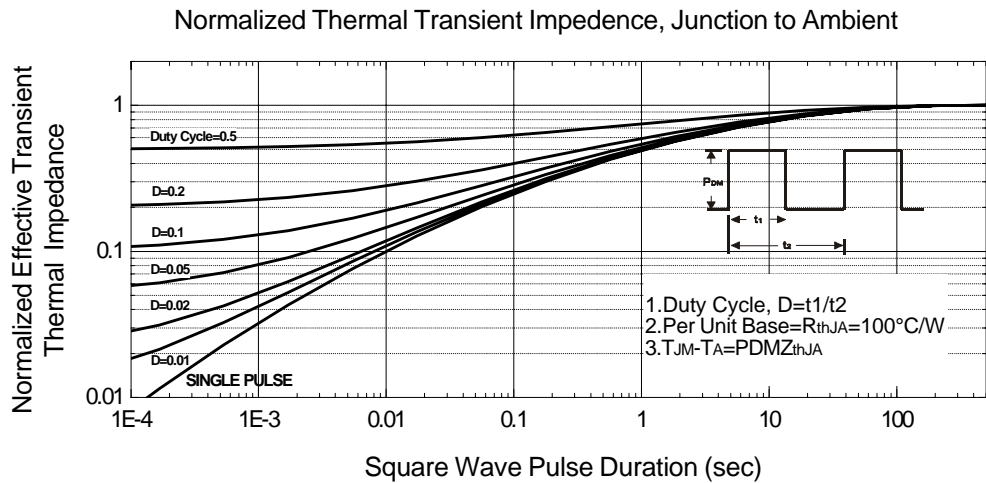
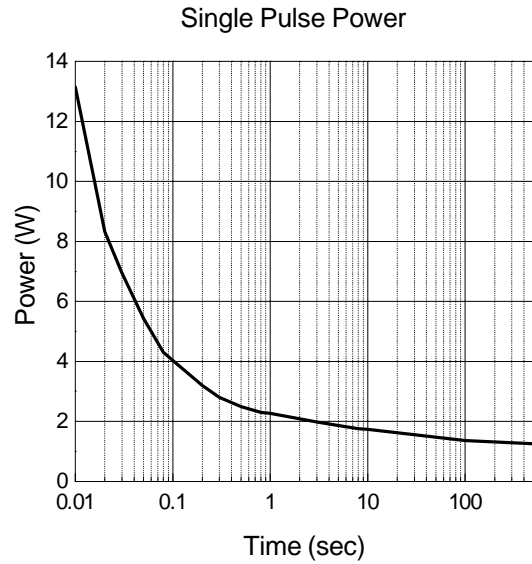
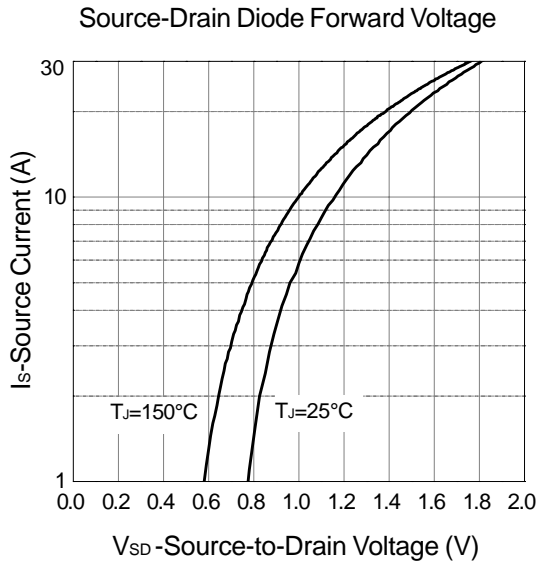

Packaging Information

SOT-23

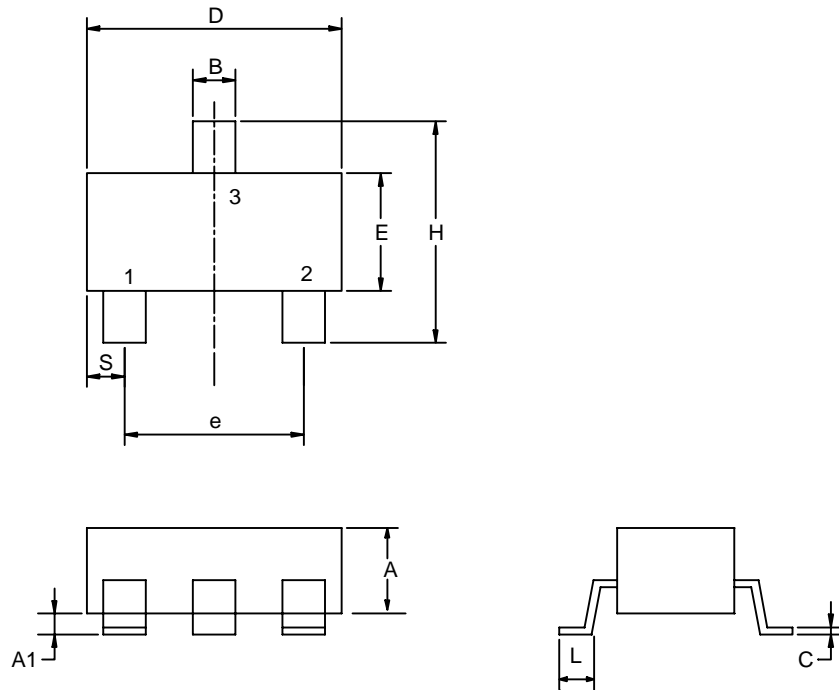

Dim	Millimeters		Inches	
	Min.	Max.	Min.	Max.
A	1.00	1.30	0.039	0.051
A1	0.00	0.10	0.000	0.004
B	0.35	0.51	0.014	0.020
C	0.10	0.25	0.004	0.010
D	2.70	3.10	0.106	0.122
E	1.40	1.80	0.055	0.071
e	1.90 BSC		0.075 BSC	
H	2.40	3.00	0.094	0.118
L	0.37		0.0015	

Physical Specifications

Terminal Material	Solder-Plated Copper (Solder Material : 90/10 or 63/37 SnPb)
Lead Solderability	Meets EIA Specification RSI86-91, ANSI/J-STD-002 Category 3.

Reflow Condition (IR/Convection or VPR Reflow)

Reference JEDEC Standard J-STD-020A APRIL 1999

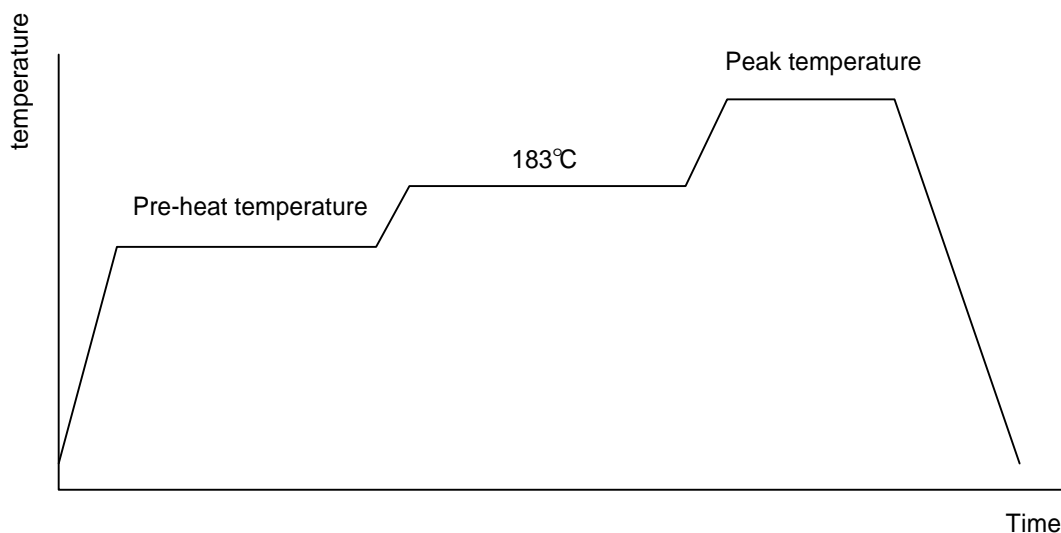

Classification Reflow Profiles

	Convection or IR/ Convection	VPR
Average ramp-up rate(183°C to Peak)	3°C/second max.	10 °C /second max.
Preheat temperature 125 ± 25°C)	120 seconds max	
Temperature maintained above 183°C	60 – 150 seconds	
Time within 5°C of actual peak temperature	10 –20 seconds	60 seconds
Peak temperature range	220 +5/-0°C or 235 +5/-0°C	215-219°C or 235 +5/-0°C
Ramp-down rate	6 °C /second max.	10 °C /second max.
Time 25°C to peak temperature	6 minutes max.	

Package Reflow Conditions

pkg. thickness ≥ 2.5mm and all bgas	pkg. thickness < 2.5mm and pkg. volume ≥ 350 mm ³	pkg. thickness < 2.5mm and pkg. volume < 350mm ³
Convection 220 +5/-0 °C		Convection 235 +5/-0 °C
VPR 215-219 °C		VPR 235 +5/-0 °C
IR/Convection 220 +5/-0 °C		IR/Convection 235 +5/-0 °C

Reliability test program

Test item	Method	Description
SOLDERABILITY	MIL-STD-883D-2003	245°C, 5 SEC
HOLT	MIL-STD 883D-1005.7	1000 Hrs Bias @ 125°C
PCT	JESD-22-B, A102	168 Hrs, 100% RH, 121°C
TST	MIL-STD 883D-1011.9	-65°C ~ 150°C, 200 Cycles

Carrier Tape

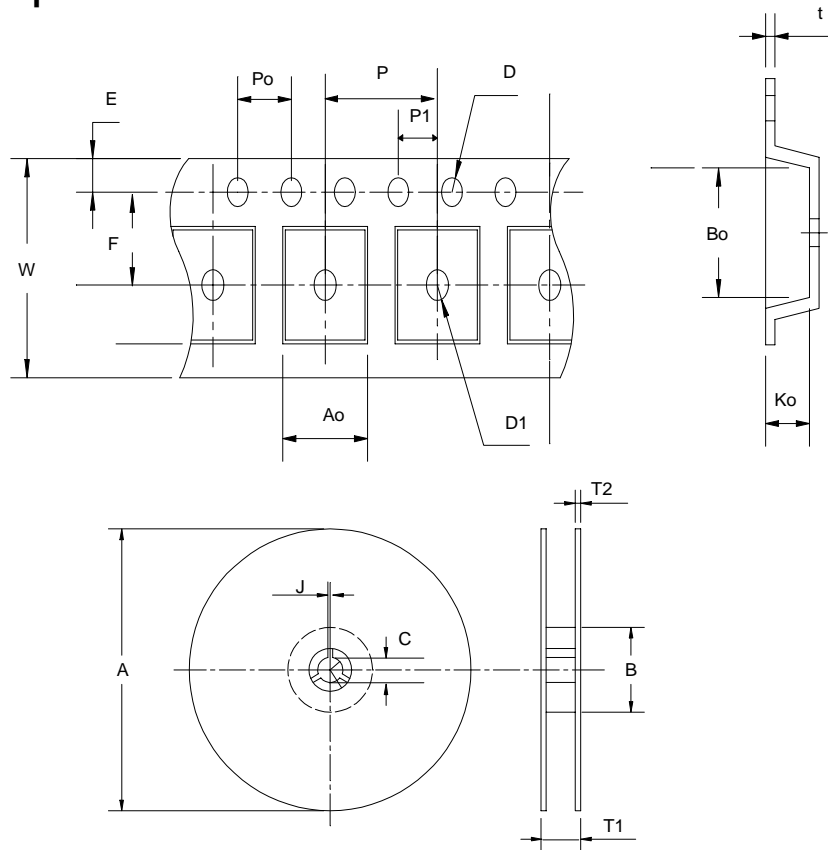

Application	A	B	C	J	T1	T2	W	P	E
SOT-23	178±1	72 ± 1.0	13.0 + 0.2	2.5 ± 0.15	8.4 ± 2	1.5 ± 0.3	8.0 ^{+0.3} _{-0.3}	4 ± 0.1	1.75 ± 0.1
	F	D	D1	Po	P1	Ao	Bo	Ko	t
	3.5 ± 0.05	1.5 + 0.1	1.5 + 0.1	4.0 ± 0.1	2.0 ± 0.1	3.15 ± 0.1	3.2 ± 0.1	1.4 ± 0.1	0.2 ± 0.03

Cover Tape Dimensions

Application	Carrier Width	Cover Tape Width	Devices Per Reel
SOT- 23	8	5.3	3000

Customer Service

Anpec Electronics Corp.

Head Office :

5F, No. 2 Li-Hsin Road, SBIP,

Hsin-Chu, Taiwan, R.O.C.

Tel : 886-3-5642000

Fax : 886-3-5642050

Taipei Branch :

7F, No. 137, Lane 235, Pac Chiao Rd.,

Hsin Tien City, Taipei Hsien, Taiwan, R. O. C.

Tel : 886-2-89191368

Fax : 886-2-89191369