

Ultra-Fast-Recovery Rectifier Diodes (Power Surface Mount)

Parameter Type No.	Absolute Maximum Ratings					Electrical Characteristics (Ta = 25°C)							Others			
	VRM (V)	IF(AV) (A)	IFSM (A) 50Hz Half-cycle Sinewave Single Shot	TJ (°C)	Tstg (°C)	VF (V)		IR (μA)	IR (H) (mA)	trr ① (ns)		trr ② (ns)		Rth (j-c) (°C/W)	Mass (g)	Fig.
						max per element	IF (A)			IF/IRP (mA)	IF/IRP (mA)					
SPX-G32S	200	3.0	50	-40 to +150	0.98	3.0	50	10	30	100/100	25	100/200	5.0	0.41	Ⓐ	
SPX-62S		6.0	80													

SPX-G32S

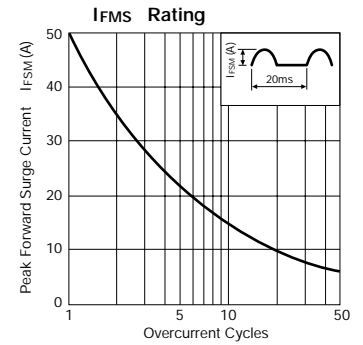
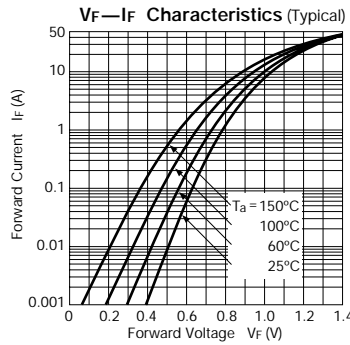
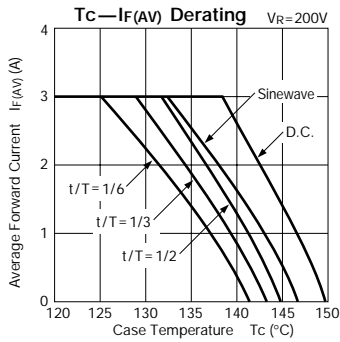

SPX-62S

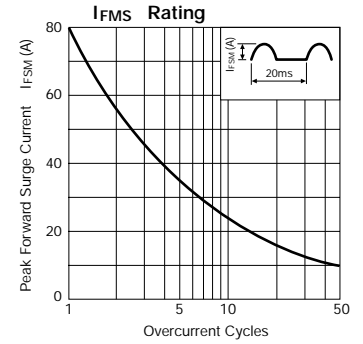
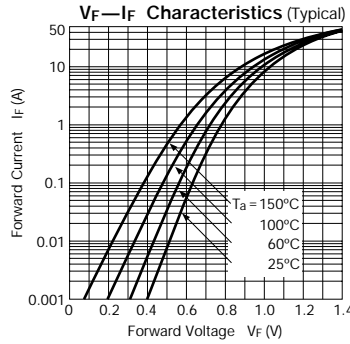
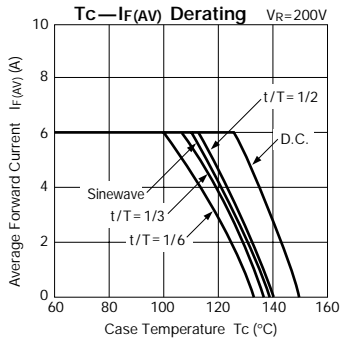

External Dimensions (Unit: mm)

Flammability:
UL94V-0 or Equivalent

Fig. Ⓐ

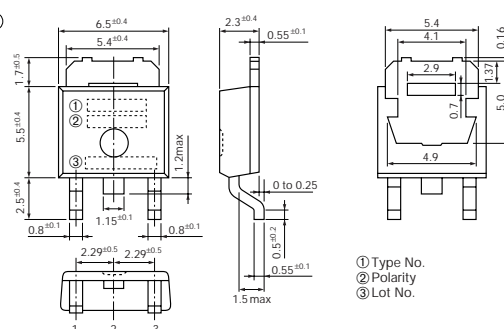

① Type No.
② Polarity
③ Lot No.

	1	2 (Common to backside of case)	3
SPX-G32S	N.C	Cathode	Anode
SPX-62S	Anode	Cathode (Common)	Anode