

4V Drive Nch+SBD MOSFET

US5U2

●Structure

Silicon N-channel MOSFET /
Schottky barrier diode

●Features

- 1) Nch MOSFET and schottky barrier diode are put in TUMT5 package.
- 2) High-speed switching, Low On-resistance.
- 3) 4V drive.
- 4) Built-in Low V_F schottky barrier diode.

●Applications

Switching

●Packaging specifications

Type	Package	Taping
	Code	TR
	Basic ordering unit (pieces)	3000
US5U2		○

●Dimensions (Unit : mm)

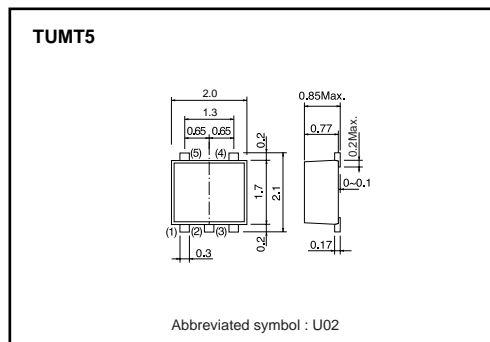

●Inner circuit

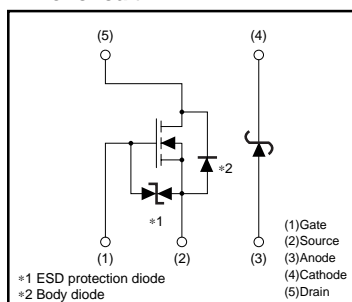

●Absolute maximum ratings (Ta=25°C)

<MOSFET>

Parameter	Symbol	Limits	Unit	
Drain-source voltage	V_{DSS}	30	V	
Gate-source voltage	V_{GSS}	20	V	
Drain current	Continuous	I_D	± 1.4	A
	Pulsed	I_{DP} *1	± 5.6	A
Source current (Body diode)	Continuous	I_S	0.6	A
	Pulsed	I_{SP} *1	5.6	A
Power dissipation	P_D *2	0.7	W / ELEMENT	
Channel temperature	T_{ch}	150	°C	

*1 $P_w \leq 10 \mu s$, Duty cycle $\leq 1\%$
*2 Mounted on a ceramic board

Transistors

<Di>

Parameter	Symbol	Limits	Unit
Repetitive peak reverse voltage	V_{RM}	30	V
Reverse voltage	V_R	20	V
Forward current	I_F	0.5	A
Forward current surge peak	I_{FSM}^{*1}	2.0	A
Power dissipation	P_D^{*2}	0.5	W / ELEMENT
Junction temperature	T_j	150	°C

*1 60Hz · 1cycle

*2 Mounted on ceramic board

<MOSFET and Di>

Parameter	Symbol	Limits	Unit
Total power dissipation	P_D^{*1}	1.0	W / TOTAL
Range of storage temperature	T_{stg}	-55 to +150	°C

*1 Mounted on a ceramic board

●Electrical characteristics (Ta=25°C)

<MOSFET>

Parameter	Symbol	Min.	Typ.	Max.	Unit	Conditions
Gate-source leakage	I_{GSS}	–	–	10	μA	$V_{GS}=20V, V_{DS}=0V$
Drain-source breakdown voltage	$V_{(BR)DSS}$	30	–	–	V	$I_D=1mA, V_{GS}=0V$
Zero gate voltage drain current	I_{DSS}	–	–	1	μA	$V_{DS}=30V, V_{GS}=0V$
Gate threshold voltage	$V_{GS(th)}$	1.0	–	2.5	V	$V_{DS}=10V, I_D=1mA$
Static drain-source on-state resistance	$R_{DS(on)}^*$	–	170	240	mΩ	$I_D=1.4A, V_{GS}=10V$
		–	250	350	mΩ	$I_D=1.4A, V_{GS}=4.5V$
		–	270	380	mΩ	$I_D=1.4A, V_{GS}=4V$
Forward transfer admittance	$ Y_{fs} ^*$	1.0	–	–	S	$V_{DS}=10V, I_D=1.4A$
Input capacitance	C_{iss}	–	70	–	pF	$V_{DS}=10V$
Output capacitance	C_{oss}	–	15	–	pF	$V_{GS}=0V$
Reverse transfer capacitance	C_{rss}	–	12	–	pF	$f=1MHz$
Turn-on delay time	$t_{d(on)}^*$	–	6	–	ns	$V_{DD} \doteq 15V$
Rise time	t_r^*	–	6	–	ns	$I_D=0.7A$
Turn-off delay time	$t_{d(off)}^*$	–	13	–	ns	$V_{GS}=10V$
Fall time	t_f^*	–	8	–	ns	$R_L=21\Omega$
Total gate charge	Q_g^*	–	1.4	2.0	nC	$V_{DD} \doteq 15V, V_{GS}=5V$
Gate-source charge	Q_{gs}^*	–	0.6	–	nC	$I_D=1.4A$
Gate-drain charge	Q_{gd}^*	–	0.3	–	nC	$R_L=11\Omega, R_G=10\Omega$

*Pulsed

<Body diode characteristics (source-drain)>

Parameter	Symbol	Min.	Typ.	Max.	Unit	Conditions
Forward voltage	V_{SD}	–	–	1.2	V	$I_S=0.6A, V_{GS}=0V$

<Di>

Parameter	Symbol	Min.	Typ.	Max.	Unit	Conditions
Forward voltage	V_F	–	–	0.36	V	$I_F=0.1A$
		–	–	0.47	V	$I_F=0.5A$
Reverse current	I_R	–	–	100	μA	$V_R=20V$

Transistors

●Electrical characteristics curves

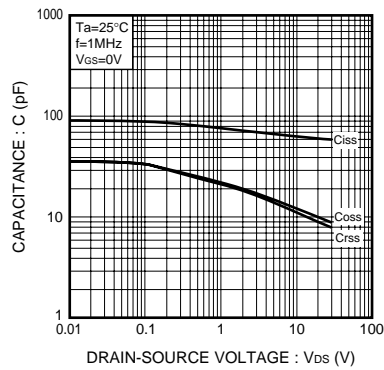

Fig.1 Typical Capacitance vs. Drain-Source Voltage

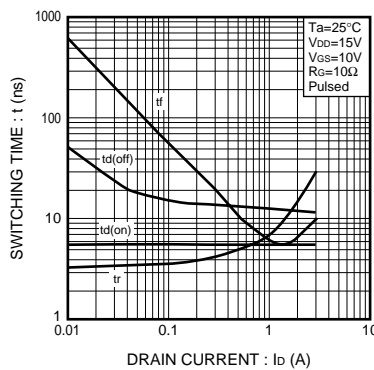

Fig.2 Switching Characteristics

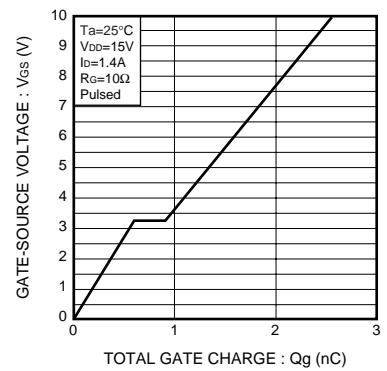

Fig.3 Dynamic Input Characteristics

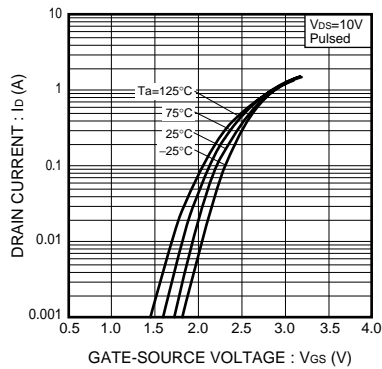

Fig.4 Typical Transfer Characteristics

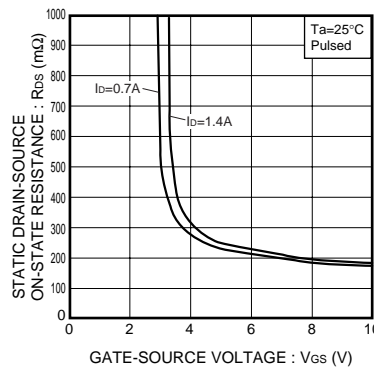

Fig.5 Static Drain-Source On-State Resistance vs. Gate-source Voltage

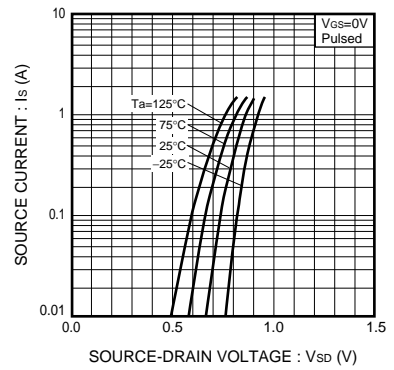

Fig.6 Source Current vs. Source-Drain Voltage

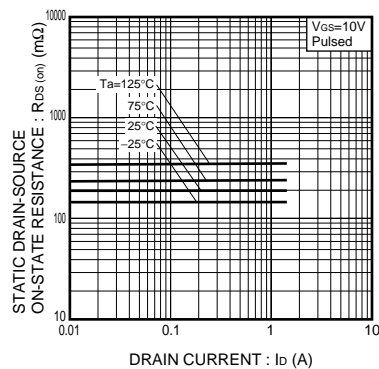

Fig.7 Static Drain-Source On-State Resistance vs. Drain Current (I)

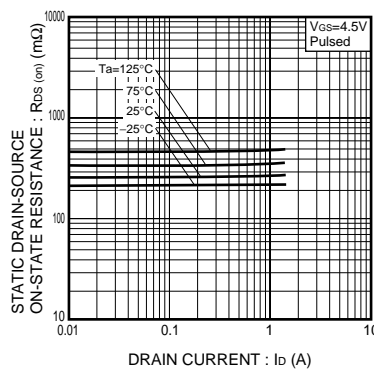

Fig.8 Static Drain-Source On-State Resistance vs. Drain Current (II)

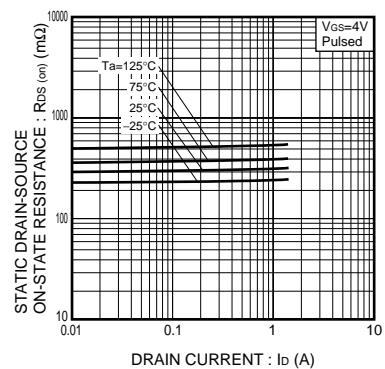

Fig.9 Static Drain-Source On-State Resistance vs. Drain Current (III)

Transistors

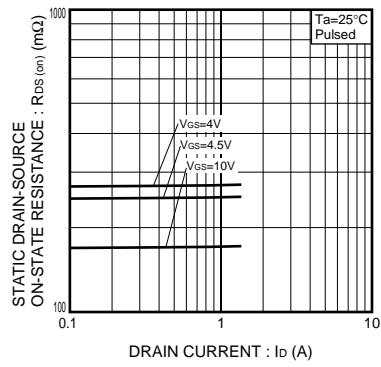

Fig.10 Static Drain-Source On-State Resistance vs. Drain Current (IV)

Notes

- No technical content pages of this document may be reproduced in any form or transmitted by any means without prior permission of ROHM CO.,LTD.
- The contents described herein are subject to change without notice. The specifications for the product described in this document are for reference only. Upon actual use, therefore, please request that specifications to be separately delivered.
- Application circuit diagrams and circuit constants contained herein are shown as examples of standard use and operation. Please pay careful attention to the peripheral conditions when designing circuits and deciding upon circuit constants in the set.
- Any data, including, but not limited to application circuit diagrams information, described herein are intended only as illustrations of such devices and not as the specifications for such devices. ROHM CO.,LTD. disclaims any warranty that any use of such devices shall be free from infringement of any third party's intellectual property rights or other proprietary rights, and further, assumes no liability of whatsoever nature in the event of any such infringement, or arising from or connected with or related to the use of such devices.
- Upon the sale of any such devices, other than for buyer's right to use such devices itself, resell or otherwise dispose of the same, no express or implied right or license to practice or commercially exploit any intellectual property rights or other proprietary rights owned or controlled by
- ROHM CO., LTD. is granted to any such buyer.
- Products listed in this document are no antiradiation design.

The products listed in this document are designed to be used with ordinary electronic equipment or devices (such as audio visual equipment, office-automation equipment, communications devices, electrical appliances and electronic toys).

Should you intend to use these products with equipment or devices which require an extremely high level of reliability and the malfunction of which would directly endanger human life (such as medical instruments, transportation equipment, aerospace machinery, nuclear-reactor controllers, fuel controllers and other safety devices), please be sure to consult with our sales representative in advance.

About Export Control Order in Japan

Products described herein are the objects of controlled goods in Annex 1 (Item 16) of Export Trade Control Order in Japan.

In case of export from Japan, please confirm if it applies to "objective" criteria or an "informed" (by MITI clause) on the basis of "catch all controls for Non-Proliferation of Weapons of Mass Destruction.