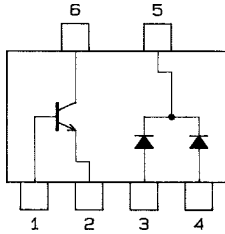

**FX803**

TR:NPN Epitaxial Planar Silicon Transistor
SBD:Schottky Barrier Diode (Twin type · Cathode Common)

DC-DC Converter**Features**

- Complex type of a low saturation voltage, high speed switching and large current NPN transistor and a fast recovery and low forward voltage Schottky barrier diode facilitating high-density mounting.
- The FX803 is composed of 2 chips, one being equivalent to the 2SB1628 and the other the SB20W03P, placed in one package.

Electrical Connection

- 1:Base
2:Emitter
3:Anode1
4:Anode2
5:Cathode
6:Collector

(Top view)

Package Dimensions

unit:mm

2126

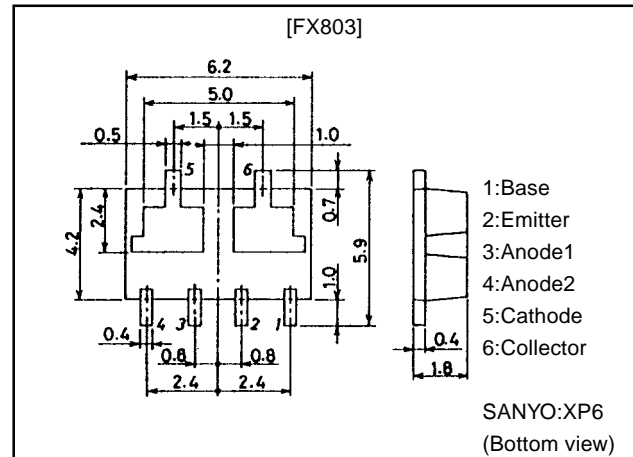
**Specifications****Absolute Maximum Ratings at Ta = 25°C**

Parameter	Symbol	Conditions	Ratings	Unit
[TR]				
Collector-to-Base Voltage	V _{CB0}		60	V
Collector-to-Emitter Voltage	V _{CE0}		20	V
Emitter-to-Base Voltage	V _{EB0}		6	V
Collector Current	I _C		5	A
Collector Current (Pulse)	I _{CP}		8	A
Base Current	I _B		1	A
Collector Dissipation	P _C	Mounted on ceramic board (750mm ² ×0.8mm) 1 unit	1.5	W
Junction Temperature	T _J		150	°C
[SBD] (Value per element)				
Repetitive Peak Reverse Voltage	V _{RRM}		30	V
Non-repetitive Peak Reverse Surge Voltage	V _{RSM}		35	V
Average Rectified Current	I _O		2	A
	I _O	(Total)	4	A
Surge Forward Current	I _{FSM}	50Hz sine wave, 1cycle	10	A
Junction Temperature	T _J		-55 to +125	°C
Storage Temperature	T _{stg}		-55 to +125	°C

· Marking:803

Continued on next page.

FX803

Continued from preceding page.

Electrical Characteristics at Ta = 25°C

Parameter	Symbol	Conditions	Ratings			Unit
			min	typ	max	
[TR]						
Collector Cutoff Current	I_{CBO}	$V_{CB}=50V, I_E=0$			100	nA
Emitter Cutoff Current	I_{EBO}	$V_{EB}=5V, I_C=0$			100	nA
DC Current Gain	$h_{FE}(1)$	$V_{CE}=2V, I_C=500mA$	160		560	
	$h_{FE}(2)$	$V_{CE}=2V, I_C=3A$	95			
Gain-Bandwidth Product	f_T	$V_{CE}=10V, I_C=500mA$		220		MHz
Output Capacitance	C_{ob}	$V_{CE}=10V, f=1MHz$		45		pF
C-E Saturation Voltage	$V_{CE(sat)}$	$I_C=3A, I_B=60mA$		220	500	mV
B-E Saturation Voltage	$V_{BE(sat)}$	$I_C=3A, I_B=60mA$		1.0	1.5	V
C-B Breakdown Voltage	$V_{(BR)CBO}$	$I_C=10\mu A, I_E=0$	60			V
C-E Breakdown Voltage	$V_{(BR)CEO}$	$I_E=-1mA, R_{BE}=\infty$	20			V
E-B Breakdown Voltage	$V_{(BR)EBO}$	$I_E=-10\mu A, I_C=0$	6			V
Turn-ON Time	t_{on}	See sepcified Test Circuit		30		ns
Storage Time	t_{stg}	See sepcified Test Circuit		300		ns
Fall Time	t_f	See sepcified Test Circuit		40		ns
[SBD] (Value per element)						
Reverse Voltage	V_R	$I_R=500\mu A$	30			V
Forward Voltage	V_F	$I_F=2A$			0.55	V
Reverse Current	I_R	$V_R=15V$			100	μA
Interterminal Capacitance	C	$V_R=10V, f=1MHz$		70		pF
Reverse Recovery Time	t_{rr}	$I_F=I_R=100mA$, See specified Test Circuit			20	ns
Thermal Resistance	R_{thj-a}	Mounted on ceramic board (750mm ² ×0.8mm)		85		°C/W

Switching Time Test Clrcuit [TR]

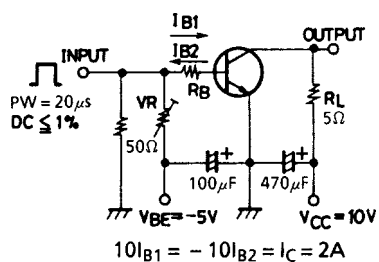

Trr Test Circuit [SBD]

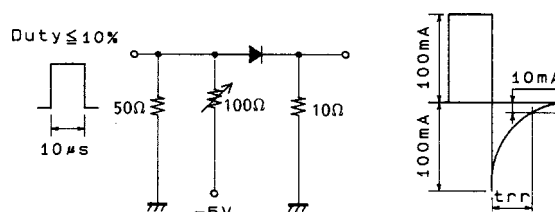

FX803

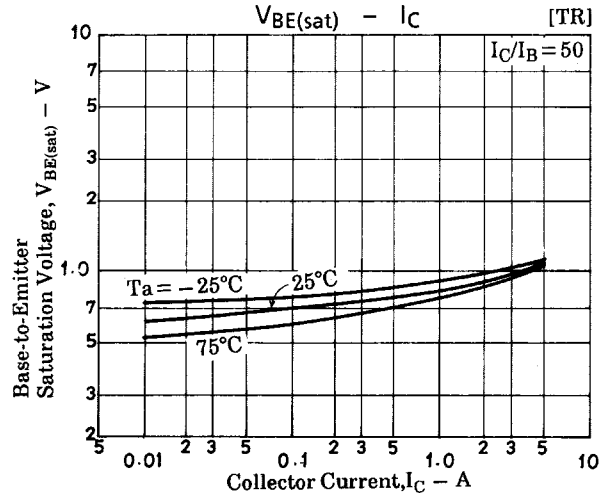
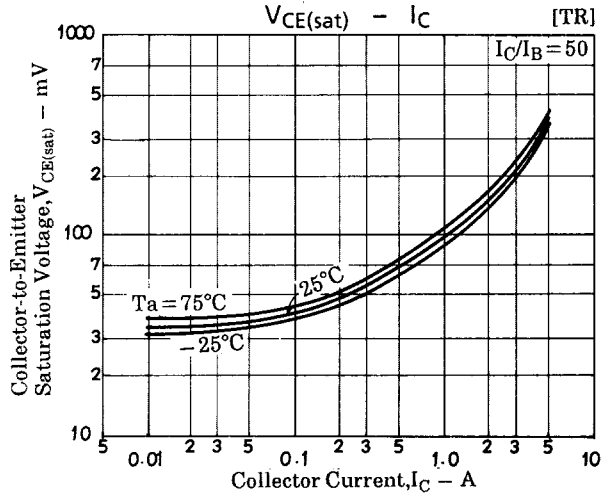
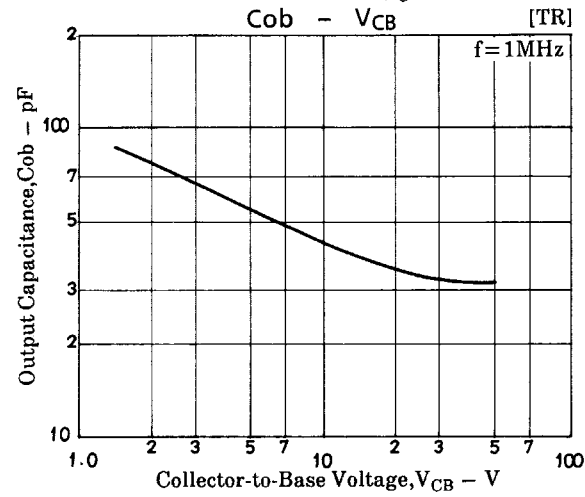
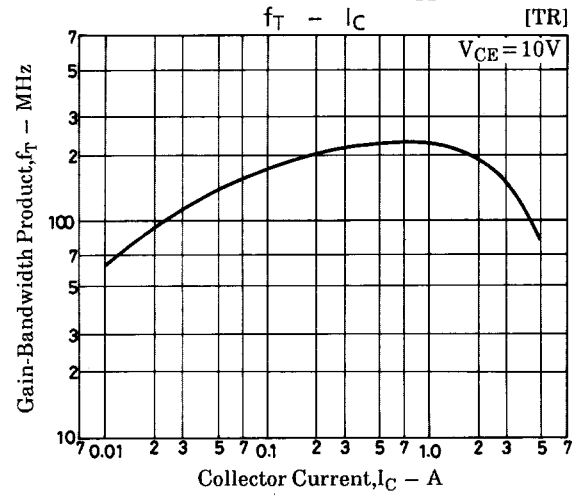
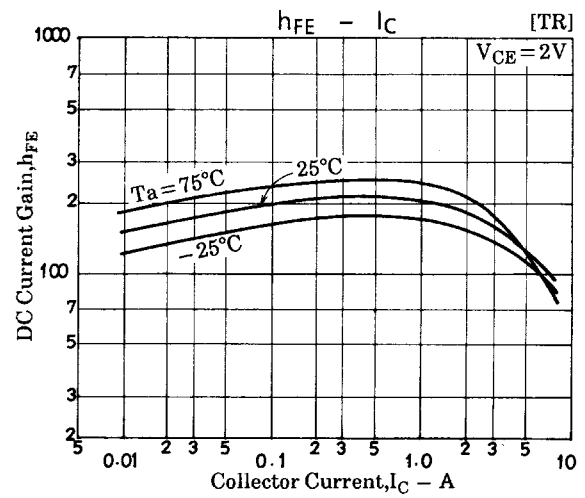
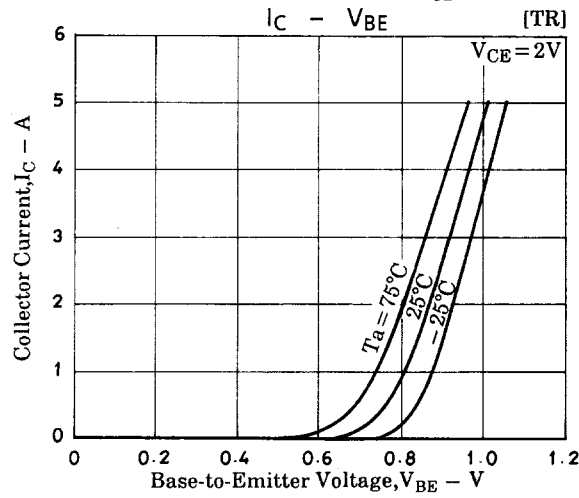
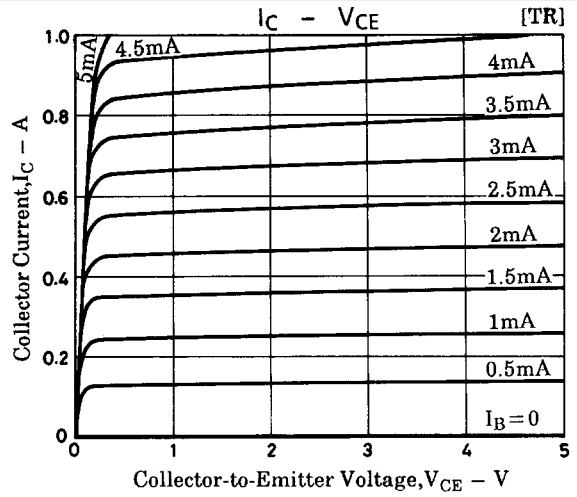
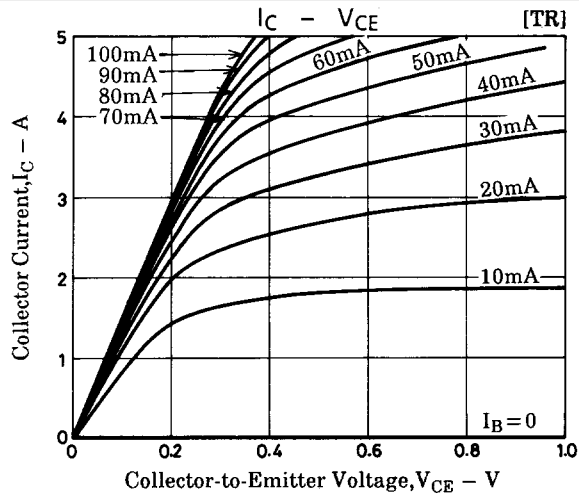

FX803

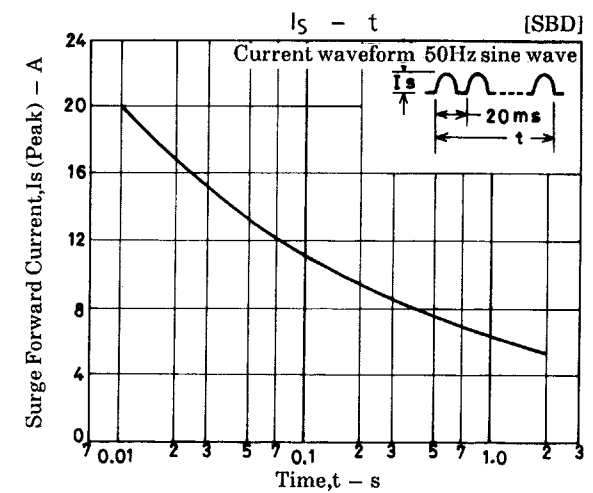
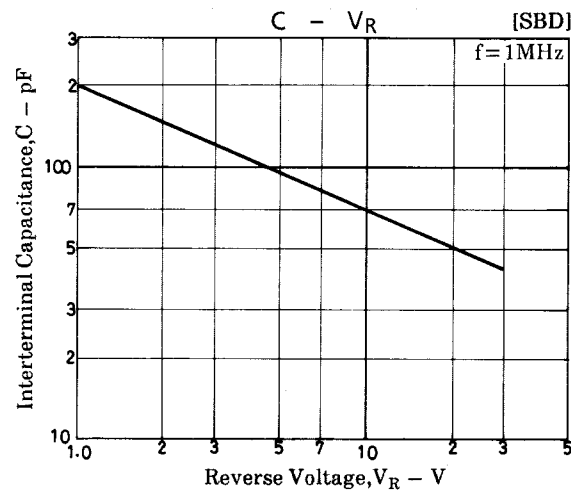
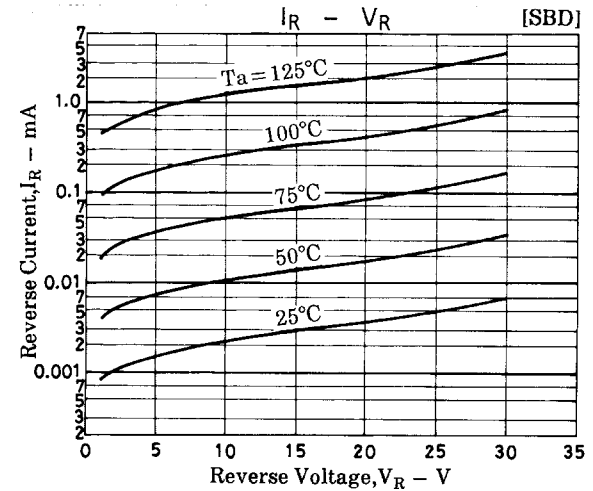
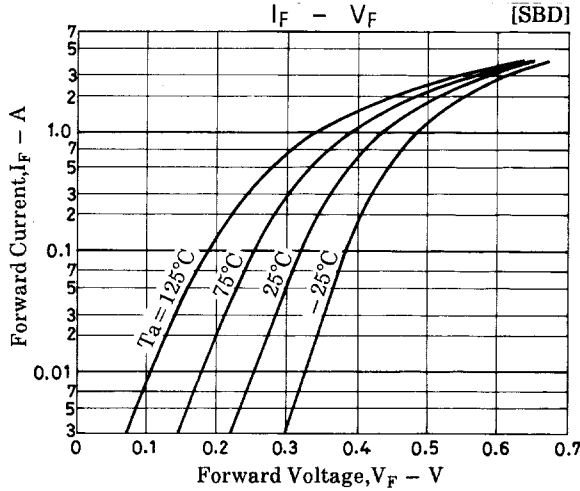
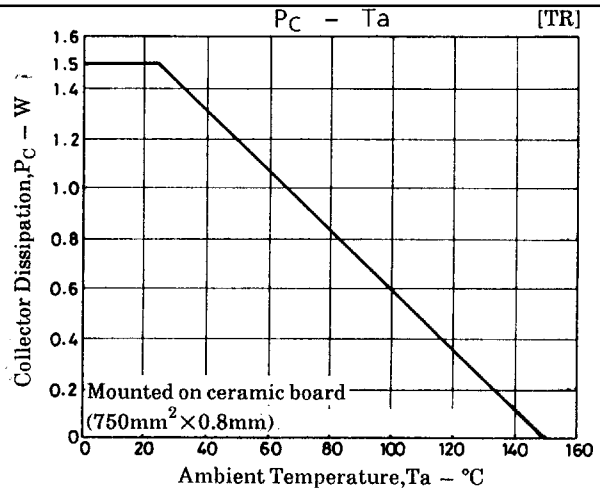
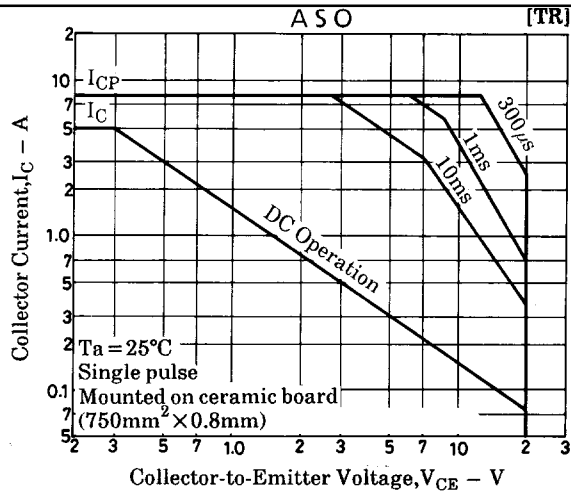

■ No products described or contained herein are intended for use in surgical implants, life-support systems, aerospace equipment, nuclear power control systems, vehicles, disaster/crime-prevention equipment and the like, the failure of which may directly or indirectly cause injury, death or property loss.

■ Anyone purchasing any products described or contained herein for an above-mentioned use shall:

- ① Accept full responsibility and indemnify and defend SANYO ELECTRIC CO., LTD., its affiliates, subsidiaries and distributors and all their officers and employees, jointly and severally, against any and all claims and litigation and all damages, cost and expenses associated with such use:
- ② Not impose any responsibility for any fault or negligence which may be cited in any such claim or litigation on SANYO ELECTRIC CO., LTD., its affiliates, subsidiaries and distributors or any of their officers and employees jointly or severally.

■ Information (including circuit diagrams and circuit parameters) herein is for example only; it is not guaranteed for volume production. SANYO believes information herein is accurate and reliable, but no guarantees are made or implied regarding its use or any infringements of intellectual property rights or other rights of third parties.

This catalog provides information as of May, 1998. Specifications and information herein are subject to change without notice.