

# BIPOLAR ANALOG INTEGRATED CIRCUITS

# $\mu$ PC8119T, $\mu$ PC8120T

## VARIABLE GAIN AMPLIFIER SILICON MMIC FOR TRANSMITTER AGC OF DIGITAL CELLULAR TELEPHONE

### DESCRIPTION

The  $\mu$ PC8119T and  $\mu$ PC8120T are silicon monolithic integrated circuits designed as variable gain amplifier. Due to 100 MHz to 1.9 GHz operation, these ICs are suitable for RF transmitter AGC stage of digital cellular telephone. Two types of gain control let users choose in accordance with system design. 3 V supply voltage and mini mold package contribute to make system lower voltage, decreased space and fewer components.

The  $\mu$ PC8119T and  $\mu$ PC8120T are manufactured using NEC's 20 GHz fr NESAT™ III silicon bipolar process. This process uses silicon nitride passivation film and gold electrodes. These materials can protect chip surface from external pollution and prevent corrosion / migration. Thus, this IC has excellent performance, uniformity and reliability.

### FEATURES

- Recommended operating frequency :  $f = 100 \text{ MHz to } 1.92 \text{ GHz}$
- Supply voltage :  $V_{CC} = 2.7 \text{ to } 3.3 \text{ V}$
- Low current consumption :  $I_{CC} = 11 \text{ mA TYP. @ } V_{CC} = 3.0 \text{ V}$
- Gain control voltage :  $V_{AGC} = 0.6 \text{ to } 2.4 \text{ V (recommended)}$
- Two types of gain control :  $\mu$ PC8119T =  $V_{AGC}$  up vs. Gain down (Forward control)  
 $\mu$ PC8120T =  $V_{AGC}$  up vs. Gain up (Reverse control)
- AGC control can be constructed by external control circuit.
- High-density surface mounting

### APPLICATIONS

- 1.9 GHz cordless telephone (PHS base-station and so on)
- 800 MHz to 900 MHz or 1.5 GHz Digital cellular telephone (PDC800M, PDC1.5G and so on)

### ORDERING INFORMATION

Part Number	Package	Marking	Supplying Form	Gain Control Type
$\mu$ PC8119T-E3	6-pin minimold	C2M	Embossed tape 8 mm wide. 1, 2, 3 pins face to perforation side of the tape. Qty 3 k $\mu$ /reel.	Forward control
$\mu$ PC8120T-E3		C2N		Reverse control

**Remark** To order evaluation samples, please contact your local NEC sales office.  
(Part number for sample order:  $\mu$ PC8119T,  $\mu$ PC8120T)

**Caution** Electro-static sensitive devices

The information in this document is subject to change without notice. Before using this document, please confirm that this is the latest version.

**PIN CONNECTIONS**

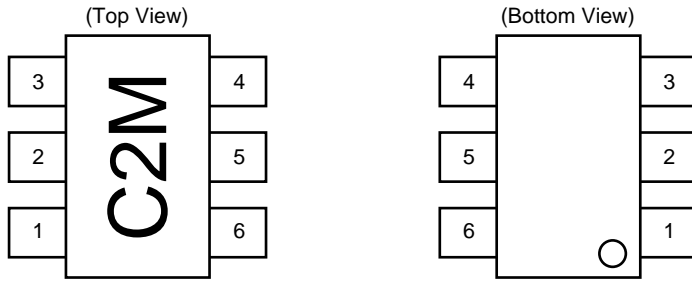

Marking is an example for  $\mu$ PC8119T.

Pin No.	Pin Name
1	INPUT
2	GND
3	GND
4	OUTPUT
5	V <sub>CC</sub>
6	V <sub>AGC</sub>

**VARIABLE GAIN AMPLIFIER PRODUCT LINE-UP**

Part No.	V <sub>CC</sub> (V)	I <sub>CC</sub> (mA)	V <sub>AGC</sub> (V)	V <sub>AGC</sub> up vs. Gain	f (GHz)	P <sub>O</sub> (1 dB)	Features
$\mu$ PC2723T	4.5 to 5.5	15	3.3 to 5.0	down	up to 1.1	-4	
$\mu$ PC8119T	2.7 to 3.3	11	0.6 to 2.4	down	0.1 to 1.92	+3	Excellent V <sub>CC</sub> fluctuation
$\mu$ PC8120T	2.7 to 3.3	11	0.6 to 2.4	up	0.1 to 1.92	+3	
$\mu$ PC8130TA	2.7 to 3.3	11	0.6 to 2.4	up	0.8 to 1.5	+5	Low distortion
$\mu$ PC8131TA	2.7 to 3.3	11	0 to 2.4	down	0.8 to 1.5	+5	Low distortion

**Remark** Typical performance. Please refer to ELECTRICAL CHARACTERISTICS in detail.  
To know the associated product, please refer to each latest data sheet.

**SYSTEM APPLICATION EXAMPLE**

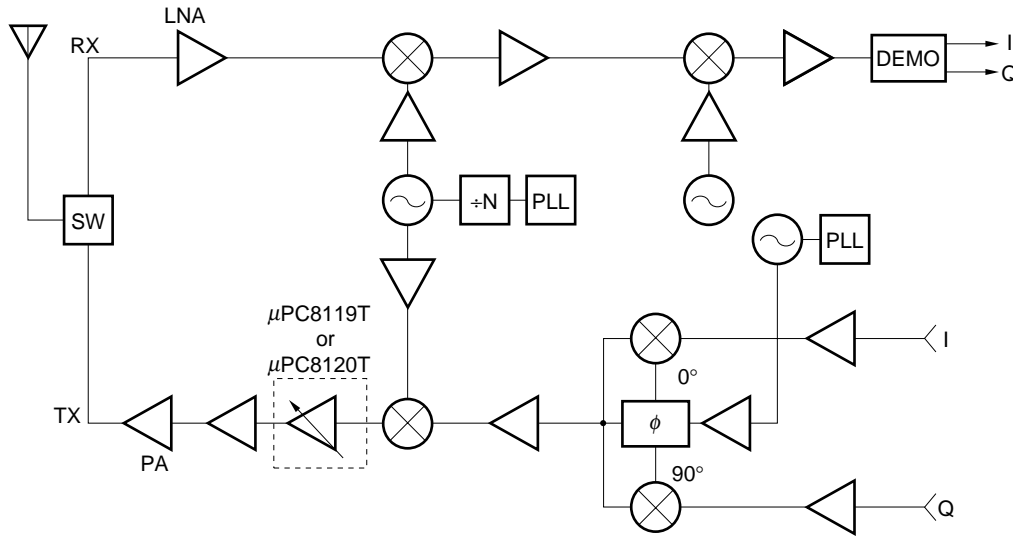

PIN EXPLANATION

Pin No.	Pin Name	Applied Voltage V	Pin Voltage V <sup>Note</sup>	Function and Applications	Internal Equivalent Circuit						
1	IN	–	1.2	RF input pin. This pin should be coupled with capacitor (eg 1000 pF) for DC cut. This pin can be input from 50 Ω impedance signal source without matching circuit.							
2 3	GND	0	–	Ground pin. This pin should be connected to system ground with minimum inductance. Ground pattern on the board should be formed as wide as possible.							
4	OUT	Voltage as same as V <sub>CC</sub> through external inductor	–	RF output pin. This pin is designed as open collector of high impedance. This pin must be externally equipped with matching circuits.							
5	V <sub>CC</sub>	2.7 to 3.3	–	Supply voltage pin. This pin must be externally equipped with low pass filter (eg π type) in order to suppress leakage from input pin. This pin also must be equipped with bypass capacitor (eg 1000 pF) to minimize ground impedance.							
6	V <sub>AGC</sub>	0 to 3.3	–	Gain control pin. The relation between product number and control performance is shown below; <table border="1" style="margin: 10px auto;"> <thead> <tr> <th>Part No.</th> <th>V<sub>AGC</sub> up vs. Gain</th> </tr> </thead> <tbody> <tr> <td>μPC8119T</td> <td>↘ down</td> </tr> <tr> <td>μPC8120T</td> <td>↗ up</td> </tr> </tbody> </table>	Part No.	V <sub>AGC</sub> up vs. Gain	μPC8119T	↘ down	μPC8120T	↗ up	
Part No.	V <sub>AGC</sub> up vs. Gain										
μPC8119T	↘ down										
μPC8120T	↗ up										

**Note** Pin voltage is measured at V<sub>CC</sub> = 3.0 V.

**ABSOLUTE MAXIMUM RATINGS**

Parameter	Symbol	Conditions	Ratings	Unit
Supply Voltage	V <sub>CC</sub>	T <sub>A</sub> = +25°C	3.6	V
Gain Control Voltage	V <sub>AGC</sub>	T <sub>A</sub> = +25°C	3.6	mA
Operating Ambient Temperature	T <sub>A</sub>		-40 to +85	°C
Storage Temperature	T <sub>stg</sub>		-55 to +150	°C
Power Dissipation of Package	P <sub>D</sub>	Mounted on double-sided copper-clad 50 × 50 × 1.6 mm epoxy glass PWB T <sub>A</sub> = +85°C	280	mW

**RECOMMENDED OPERATING CONDITIONS**

Parameter	Symbol	MIN.	TYP.	MAX.	Unit	Notice
Supply Voltage	V <sub>CC</sub>	2.7	3.0	3.3	V	Same voltage should be applied to 4 and 5 pins.
Gain Control Voltage	V <sub>AGC</sub>	0.6	-	2.4	V	I <sub>AGC</sub> ≤ 0.1 mA
Input Level	P <sub>in</sub>	-	-	-18	dBm	P <sub>adj</sub> ≤ -60 dBc @ Δf = ±50 kHz <sup>Note 1</sup>
		-	-	-10		P <sub>adj</sub> ≤ -60 dBc @ Δf = ±600 kHz <sup>Note 2</sup>
Operating Ambient Temperature	T <sub>A</sub>	-40	+25	+85	°C	
Operating Frequency	f	100	-	1920	MHz	With external output-matching
AGC Pin Drive Current	I <sub>AGC</sub>	0.5	-	-	mA	V <sub>AGC</sub> ≤ 3.3 V

- Notes**
1. Adjacent Channel Interference (P<sub>adj</sub>) wave form condition: f = 950 MHz or 1440 MHz, π/4QPSK modulation signal, data rate = 42 kbps, rolloff ratio = 0.5, PN9 bits (pseudo random pattern)
  2. Adjacent Channel Interference (P<sub>adj</sub>) wave form condition: f = 1900 MHz, π/4QPSK modulation signal, data rate = 384 kbps, rolloff ratio = 0.5, PN9 bits (pseudo random pattern)

**ELECTRICAL CHARACTERISTICS**

(Unless otherwise specified, T<sub>A</sub> = +25°C, V<sub>CC</sub> = V<sub>out</sub> = 3.0 V, Z<sub>s</sub> = Z<sub>L</sub> = 50 Ω, External matched output port)

Parameter	Symbol	Test Conditions	μPC8119T			μPC8120T			Unit
			MIN.	TYP.	MAX.	MIN.	TYP.	MAX.	
Circuit Current	I <sub>CC</sub>	No signal, I <sub>CC</sub> = I <sub>VCC</sub> + I <sub>out</sub>	7.5	11	15	7.5	11	15	mA
Maximum Power Gain	G <sub>PMAX</sub>	f = 950 MHz, P <sub>in</sub> = -30 dBm	10	12.5	15	10.5	13	15.5	dB
		f = 1440 MHz, P <sub>in</sub> = -30 dBm	10	13	16	10.5	13.5	16.5	
Gain Control Range <sup>Note</sup>	GCR	f = 950 MHz, P <sub>in</sub> = -30 dBm	40	50	-	40	50	-	dB
		f = 1440 MHz, P <sub>in</sub> = -30 dBm	35	45	-	35	45	-	
Noise Figure	NF	f = 950 MHz, G <sub>PMAX</sub>	-	8.5	11.5	-	9.0	12	dB
		f = 1440 MHz, G <sub>PMAX</sub>	-	7.5	10.5	-	7.5	10.5	
Isolation	ISL	f = 950 MHz, G <sub>PMAX</sub>	27	32	-	26	31	-	dB
		f = 1440 MHz, G <sub>PMAX</sub>	31	36	-	30	35	-	
Input Return Loss	RL <sub>in</sub>	f = 950 MHz, G <sub>PMAX</sub>	3	6	-	3	6	-	dB
		f = 1440 MHz, G <sub>PMAX</sub>	3	6	-	3	6	-	
1 dB Compression Output Power	P <sub>O</sub> (1 dB)	f = 950 MHz, G <sub>PMAX</sub>	0	+3	-	+0.5	+3.5	-	dBm
		f = 1440 MHz, G <sub>PMAX</sub>	+1.0	+4	-	0	+3	-	

**Note** Gain Control Range (GCR) specification: GCR = G<sub>PMAX</sub> - G<sub>PMIN</sub> (dB)

Conditions μPC8119T: G<sub>PMAX</sub> @ V<sub>AGC</sub> = 0 V, G<sub>PMIN</sub> @ V<sub>AGC</sub> = V<sub>CC</sub>

μPC8120T: G<sub>PMAX</sub> @ V<sub>AGC</sub> = V<sub>CC</sub>, G<sub>PMIN</sub> @ V<sub>AGC</sub> = 0 V

**Remark** Measured on TEST CIRCUIT 1 and 2

**STANDARD CHARACTERISTICS FOR REFERENCE**

(Unless otherwise specified, T<sub>A</sub> = +25°C, V<sub>CC</sub> = V<sub>out</sub> = 3.0 V, Z<sub>s</sub> = Z<sub>L</sub> = 50 Ω, External matched output port)

Parameter	Symbol	Test Conditions	Reference Value		Unit
			μPC8119T	μPC8120T	
Maximum Power Gain	G <sub>PMAX</sub>	f = 1900 MHz, P <sub>in</sub> = -30 dBm	12.5	13	dB
Gain Control Range <sup>Note</sup>	GCR	f = 1900 MHz, P <sub>in</sub> = -30 dBm	22	22	dB
Noise Figure	NF	f = 1900 MHz, G <sub>PMAX</sub>	7.2	7.3	dB
1 dB Compression Output Power	P <sub>O</sub> (1 dB)	f = 1900 MHz, G <sub>PMAX</sub>	+3.0	+2.5	dBm

**Note** Gain Control Range (GCR) specification: GCR = G<sub>PMAX</sub> - G<sub>PMIN</sub> (dB)

Conditions μPC8119T: G<sub>PMAX</sub> @ V<sub>AGC</sub> = 0 V, G<sub>PMIN</sub> @ V<sub>AGC</sub> = V<sub>CC</sub>

μPC8120T: G<sub>PMAX</sub> @ V<sub>AGC</sub> = V<sub>CC</sub>, G<sub>PMIN</sub> @ V<sub>AGC</sub> = 0 V

**Remark** Measured on APPLICATION CIRCUIT EXAMPLE

TEST CIRCUIT1 (f = 950 MHz, both products in common)

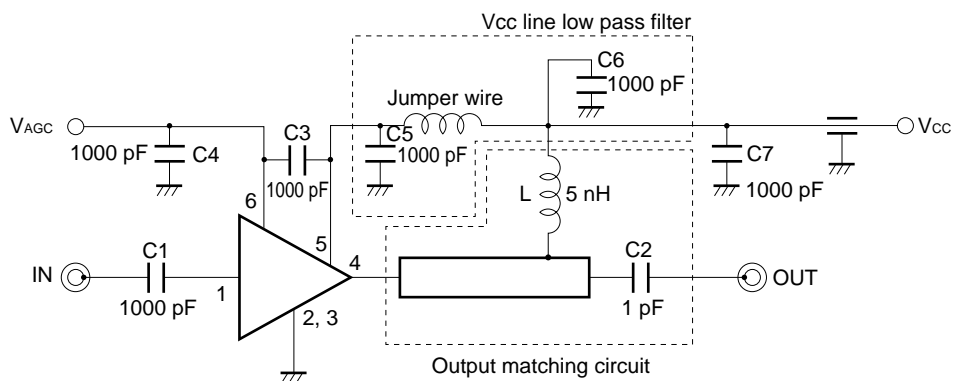
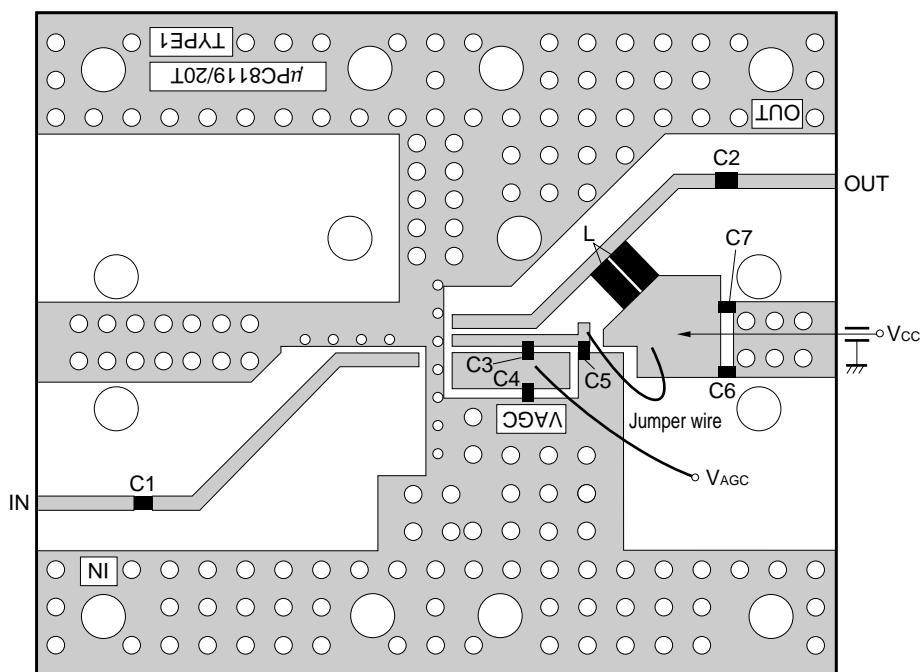

ILLUSTRATION OF TEST CIRCUIT1 ASSEMBLED ON EVALUATION BOARD



COMPONENT LIST

Form	Symbol	Value
Chip capacitor	C1, C3 to C7	1000 pF
	C2	1 pF <sup>Note 1</sup>
Chip inductor	L	5 nH (10 nH × 2 pcs parallel) <sup>Note 2</sup>
Jumper wire	Jumper wire	5 nH

- Notes**
- 1 pF : Murata Mfg. Co., Ltd. GR40CK010C
  - 10 nH : Murata Mfg. Co., Ltd. LQP31A10NG04

TEST CIRCUIT2 (f = 1440 MHz, both products in common)

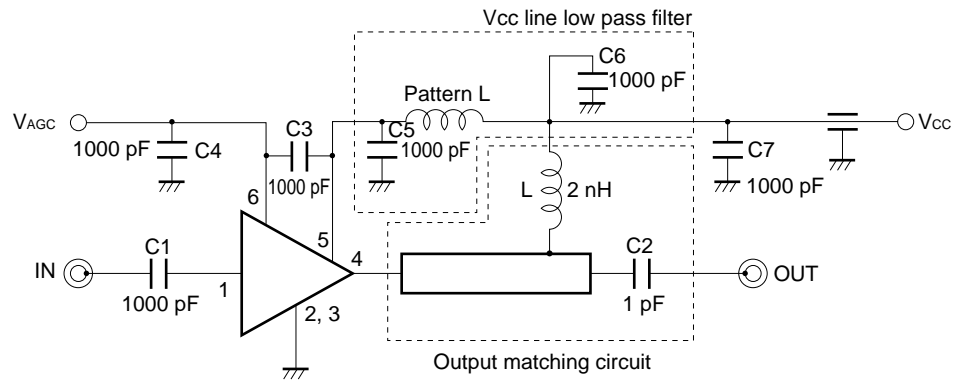
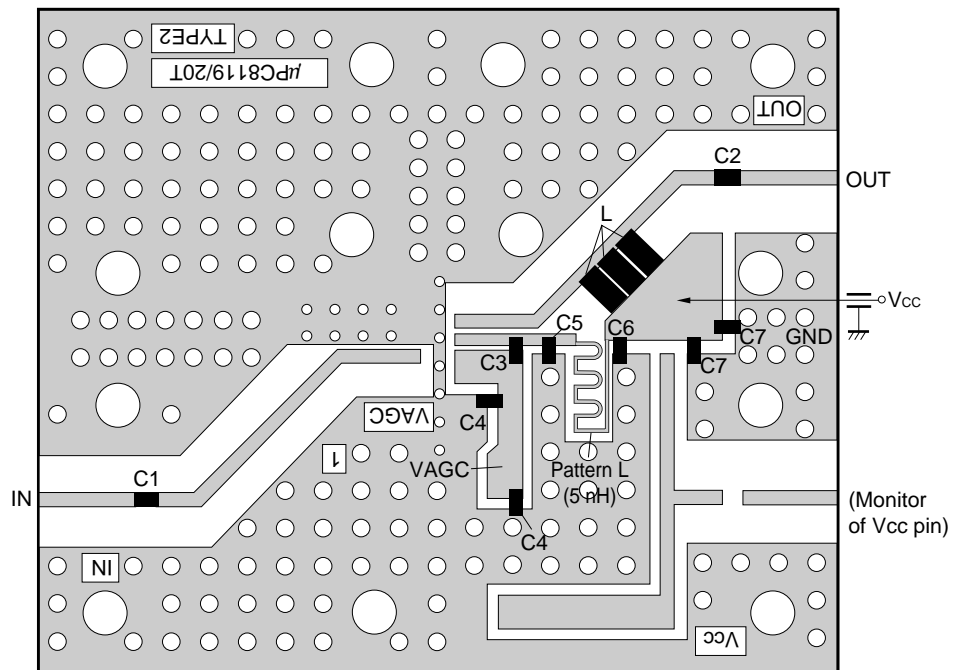

ILLUSTRATION OF TEST CIRCUIT2 ASSEMBLED ON EVALUATION BOARD



COMPONENT LIST

Form	Symbol	Value
Chip capacitor	C1, C3 to C7	1000 pF
	C2	1 pF <sup>Note 1</sup>
Chip inductor	L	2 nH (4.7 nH + 6.8 nH × 2 pcs parallel) <sup>Note 2</sup>
Printed on board	Pattern L	5 nH

- Notes**
- 1 pF : Murata Mfg. Co., Ltd. GR40CK010C
  - 4.7 nH : Murata Mfg. Co., Ltd. LQP31A4N7J04  
6.8 nH : Murata Mfg. Co., Ltd. LQP31A6N8J04

APPLICATION CIRCUIT EXAMPLE (f = 1900 MHz, both products in common)

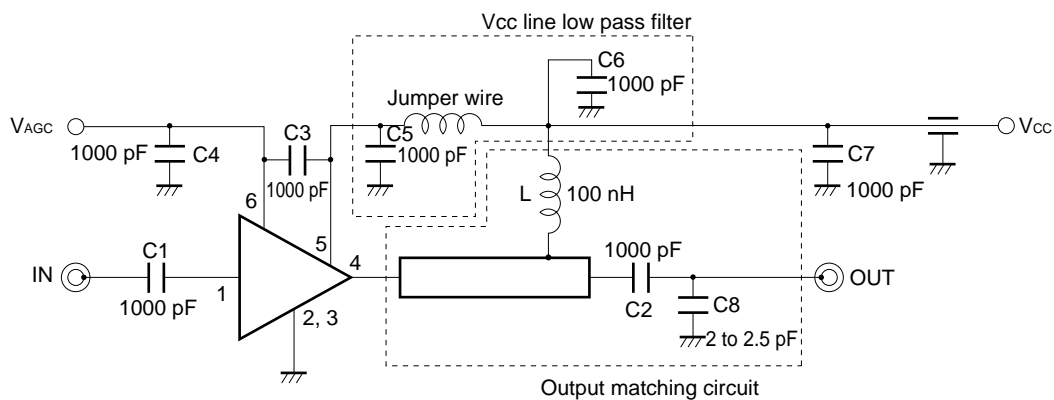
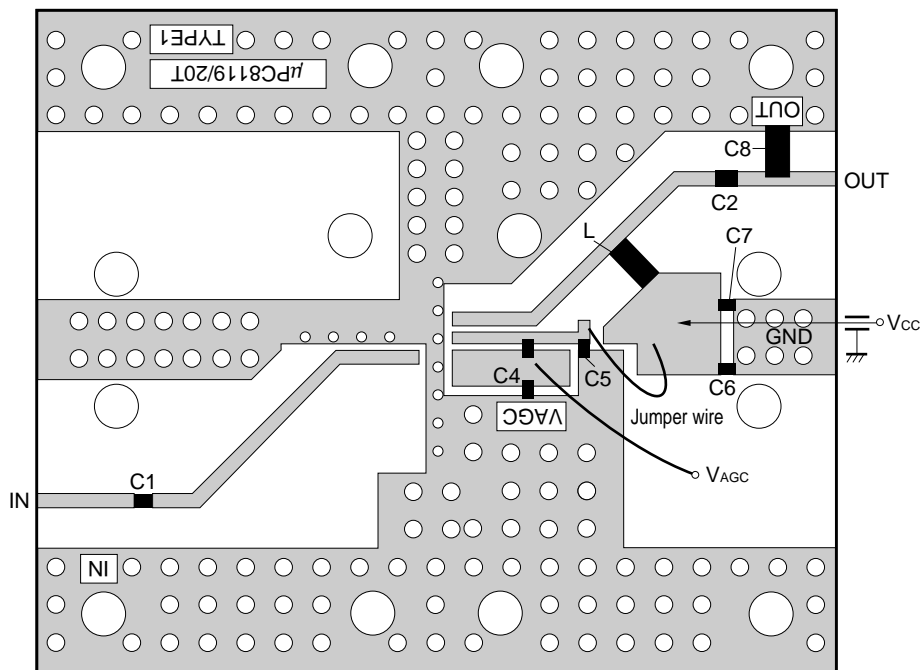

ILLUSTRATION OF APPLICATION CIRCUIT EXAMPLE ASSEMBLED ON EVALUATION BOARD



COMPONENT LIST

Form	Symbol	Value
Chip capacitor	C1 to C7	1000 pF
	C8	2 to 2.5 pF
Chip inductor	L	100 nH <sup>Note</sup>
Printed on board	Jumper wire	5 nH

**Note** 100 nH: Murata Mfg. Co., Ltd. LQP31A10NG04



ILLUSTRATION AND EXPLANATIONS OF EVALUATION BOARD

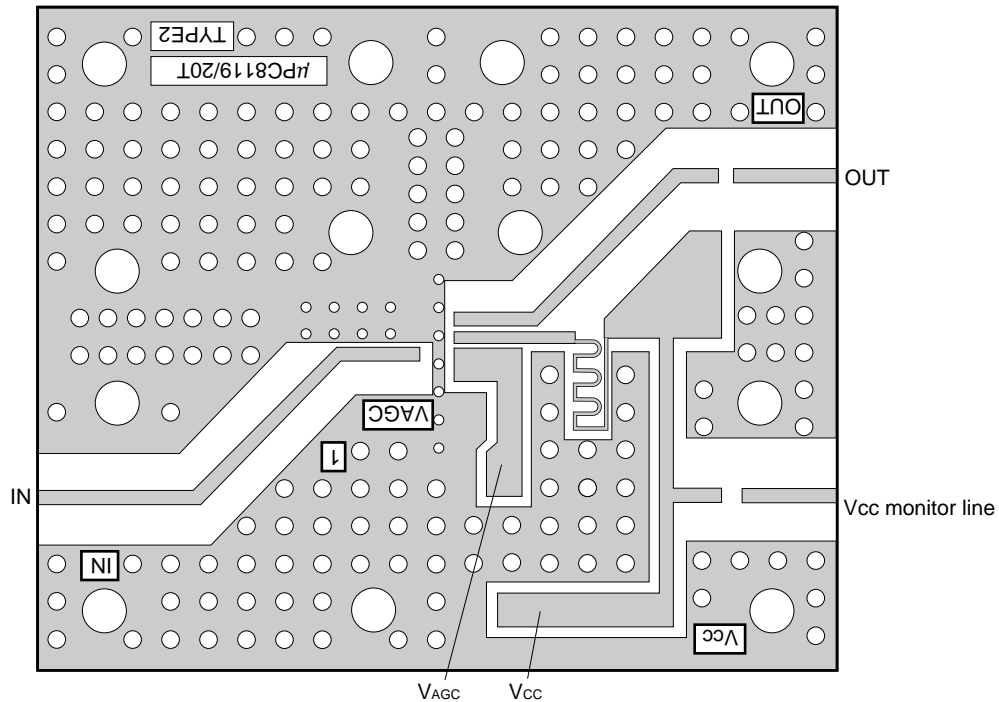

**EXPLANATION**

- <1> This board prints the pattern inductor which inductance is as same as jumper wire in TEST CIRCUITS (inductance: approx. 5 nH to 6 nH).
- <2> Input leakage to Vcc pin can be monitored through 'Vcc monitor line'. This leakage can be suppressed with  $\pi$  type low pass filter attached to Vcc pin. The filter performance depends on parallel capacitors.
- <3> After adjusted low pass filter, monitor line should be removed before output matching circuit is attached.

**EVALUATION BOARD CHARACTERS**

- (1) 35  $\mu$ m thick double-sided copper clad 35 × 42 × 0.4 mm polyimide board
- (2) Back side: GND pattern
- (3) Solder plated patterns
- (4) ○: Through holes

**ATTENTION** Test circuit or print pattern in this sheet is for testing IC characteristics.

In the case of actual system application, external circuits including print pattern and matching circuit constant of output port should be designed in accordance with IC's S parameters and environmental components.

APPLICATION for  $\mu$ PC8119T,  $\mu$ PC8120T

## 1. TO GET MINIMUM GAIN

-1. **V<sub>CC</sub> line filtering**

A low pass filter must be attached to V<sub>CC</sub> line in order to suppress RF input leakage to V<sub>CC</sub>. (The low pass filter: for example  $\pi$  type.) This filter must be inserted between V<sub>CC</sub> pin and matching inductor. If the low pass filter is not attached to this point, minimum output level would not go down under the leakage level. For example,  $\mu$ PC8119T's RF input leakage level to V<sub>CC</sub> shows -30 dBm at 950 MHz and -17 dBm at 1440 dBm.

$\pi$  type low pass filter constant example

Pattern L = 5 to 6 nH, C5 = C6 = 1000 pF (Refer to TEST CIRCUIT1, 2 and APPLICATION CIRCUIT EXAMPLE)

In the case of testing on ' $\mu$ PC8119/20T TYPE2' board, monitor the input leakage to V<sub>CC</sub> pin through 'V<sub>CC</sub> monitor line' and adjust parallel capacitors to suppress leakage.

-2. **Capacitor feed-back between V<sub>AGC</sub> and V<sub>CC</sub> pins**

Feed-back capacitor between V<sub>AGC</sub> and V<sub>CC</sub> pins must be externally attached in order to decrease impedance difference.

## 2. TO GET MAXIMUM GAIN

-1. **Output matching**

As for external matching circuit, only output port should be equipped in order to get maximum gain. Output port matching in accordance with impedance of these ICs and next stage must keep the points as follows;

<1> AC points

- IC output impedance at maximum gain must be used.
- Inductance of L must be chosen to get  $S_{22} \approx -20$  dBm at maximum gain.

<2> DC point

- On LC matching, L of low DC resistance must be chosen to apply voltage as same as V<sub>CC</sub> to output pin.

## 3. OTHERS

-1. **Input connection**

Input port does not need to match externally. These ICs can be connected to front stage through coupling capacitor (eg 1000 pF) for DC cut.

-2. **V<sub>CC</sub> ON/OFF while voltage applied to V<sub>AGC</sub>**

Due to internal transistor's voltage rating, ON/OFF can be controlled with V<sub>CC</sub> voltage while 3.0 V or less is applied to V<sub>AGC</sub>.

For the usage and application of  $\mu$ PC8119T and  $\mu$ PC8120T, please refer to the application note (Document No. P12763E).

TYPICAL CHARACTERISTICS (T<sub>A</sub> = +25°C)

$\mu$ PC8119T

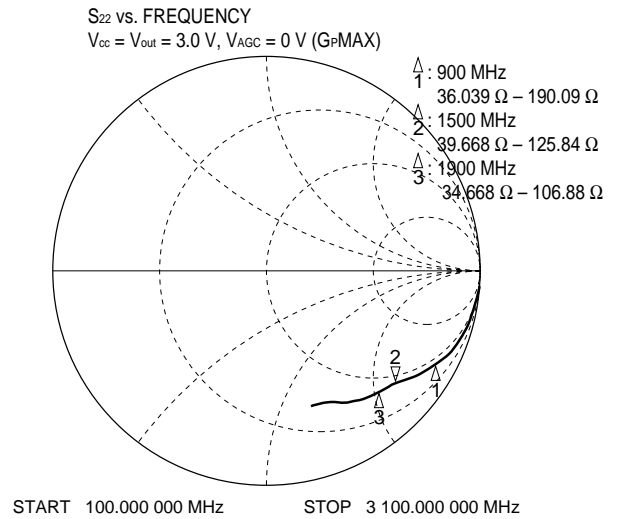
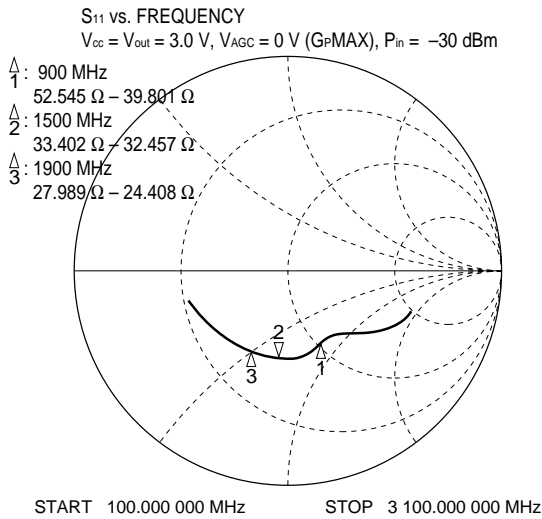
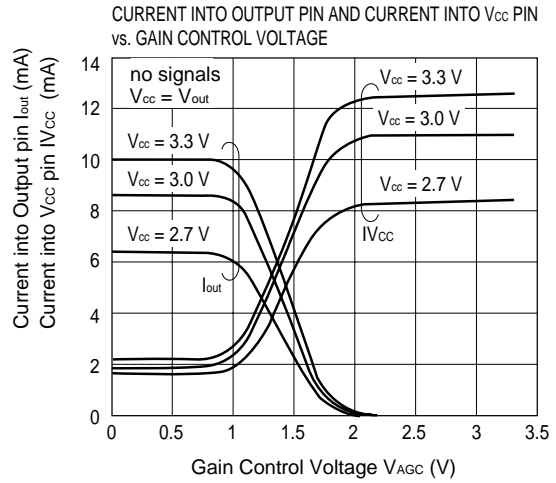
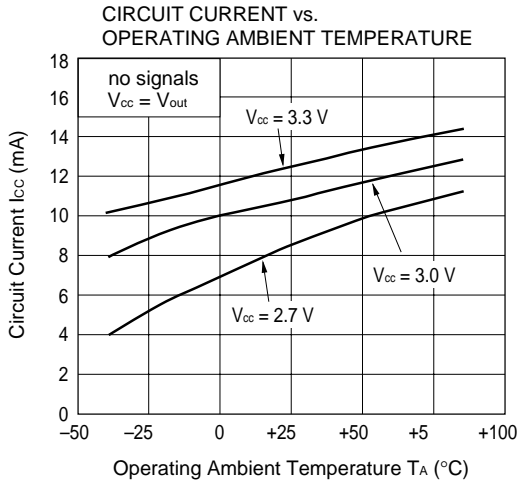
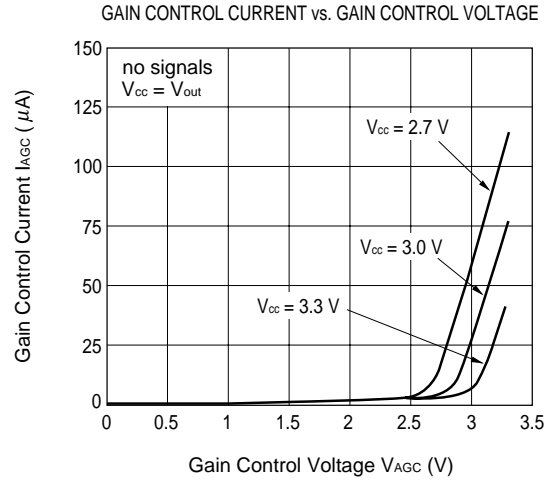
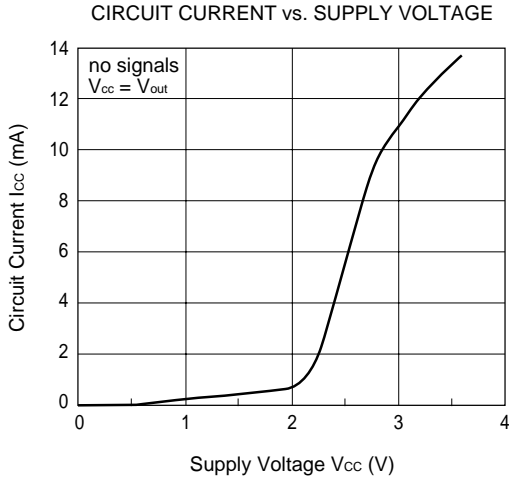

$\mu$ PC8119T

Output port matching at f = 950 MHz

$V_{cc} = V_{out} = 3.0\text{ V}$ ,  $V_{AGC} = 0\text{ V (GpMAX)}$ ,  $P_{in} = -30\text{ dBm}$

S11 vs. FREQUENCY 1; 39.367  $\Omega$  -52.375 3.1987 pF  
950.000 000 MHz

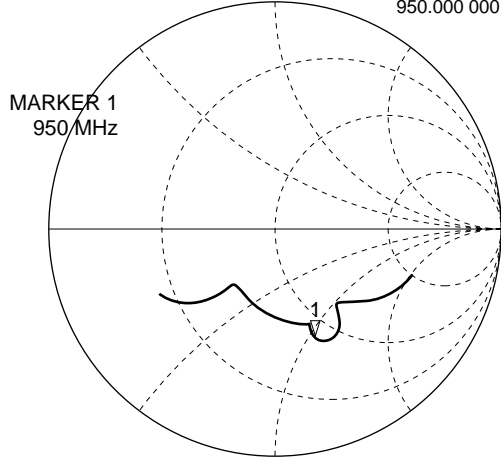

START 100.000 000 MHz STOP 310.000 000 MHz

S22 vs. FREQUENCY 1; 59.756  $\Omega$  -11.957 14.011 pF  
950.000 000 MHz

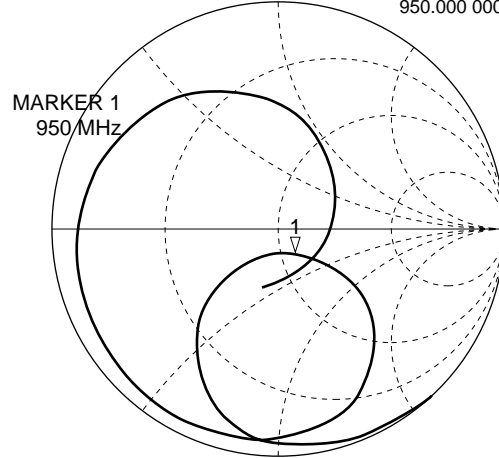

START 100.000 000 MHz STOP 310.000 000 MHz

S11 vs. FREQUENCY  
 $V_{AGC} = 0\text{ V (GpMAX)}$ ,  $P_{in} = -30\text{ dBm}$

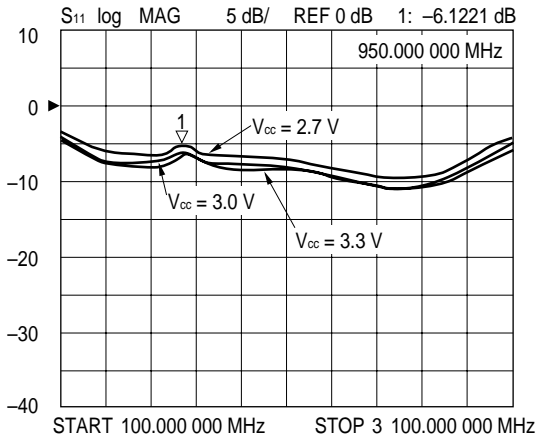

S11 vs. FREQUENCY  
 $V_{cc} = 3.0\text{ V}$ ,  $V_{AGC} = 0\text{ V (GpMAX)}$ ,  $P_{in} = -30\text{ dBm}$

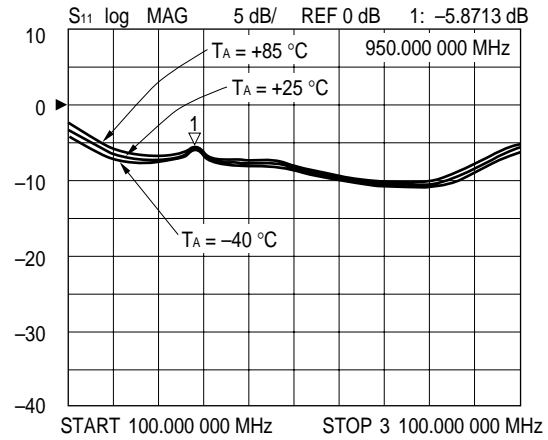

S22 vs. FREQUENCY  
 $V_{AGC} = 0\text{ V (GpMAX)}$ ,  $P_{in} = -30\text{ dBm}$

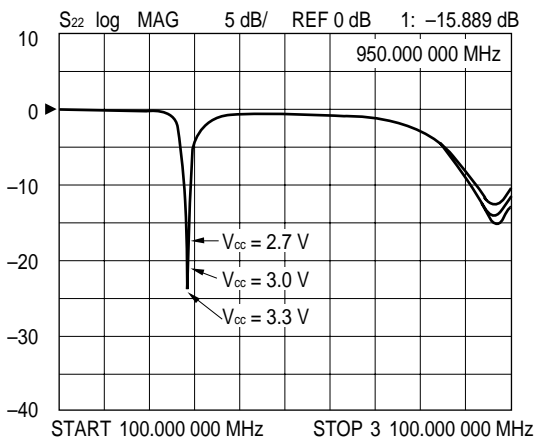

S22 vs. FREQUENCY  
 $V_{cc} = 3.0\text{ V}$ ,  $V_{AGC} = 0\text{ V (GpMAX)}$ ,  $P_{in} = -30\text{ dBm}$

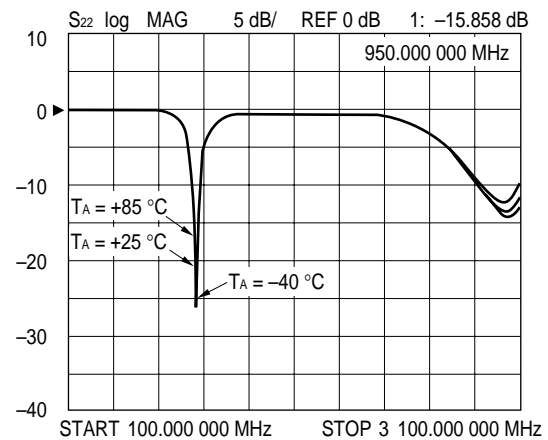

—  $\mu$ PC8119T —

Output port matching at  $f = 950$  MHz

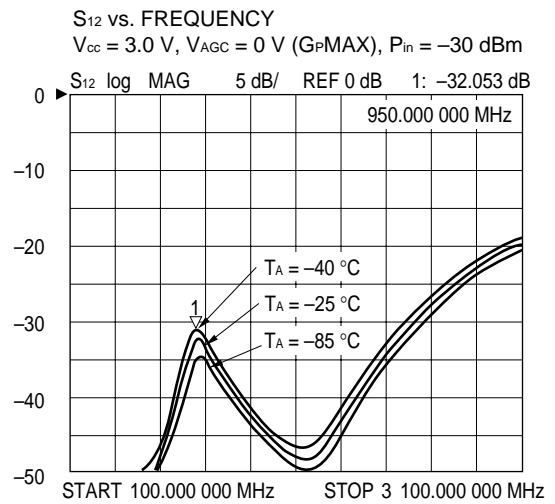
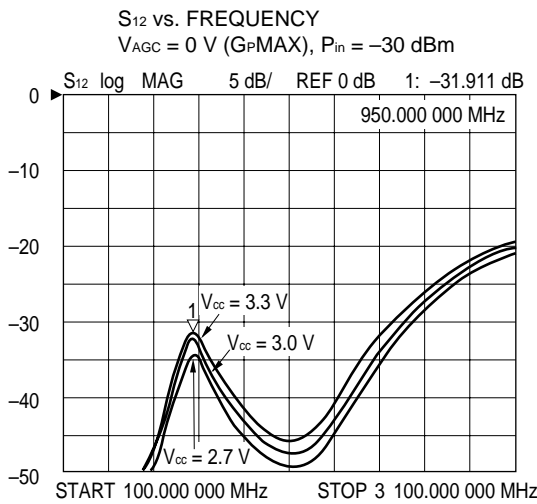
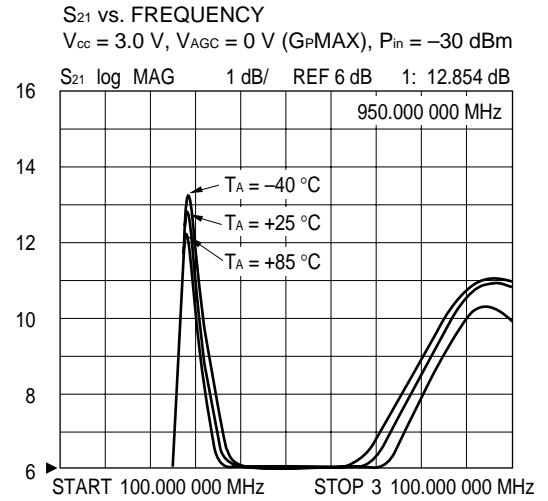
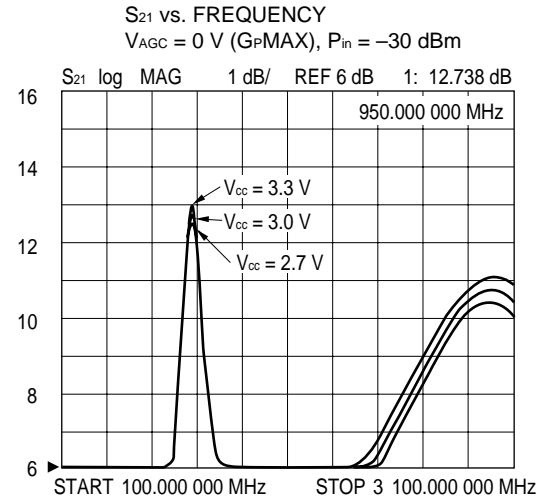

$\mu$ PC8119T

Output port matching at  $f = 950$  MHz

POWER GAIN vs. GAIN CONTROL VOLTAGE

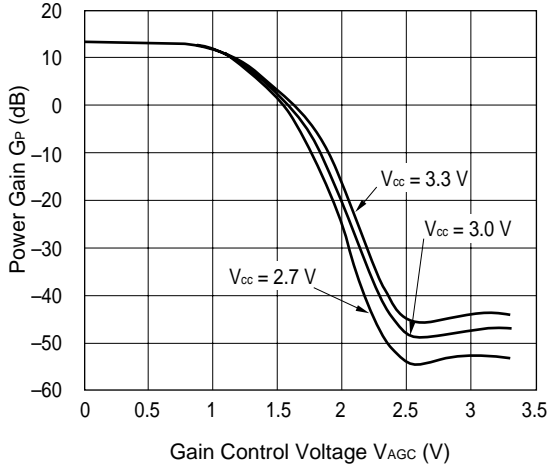

POWER GAIN vs. GAIN CONTROL VOLTAGE

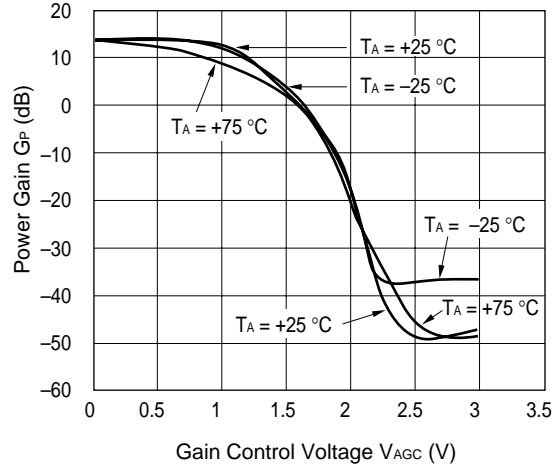

$S_{21}$  vs. FREQUENCY DEPENDENCE OF GAIN CONTROL VOLTAGE

$V_{CC} = 3.0$  V,  $P_{in} = -30$  dBm

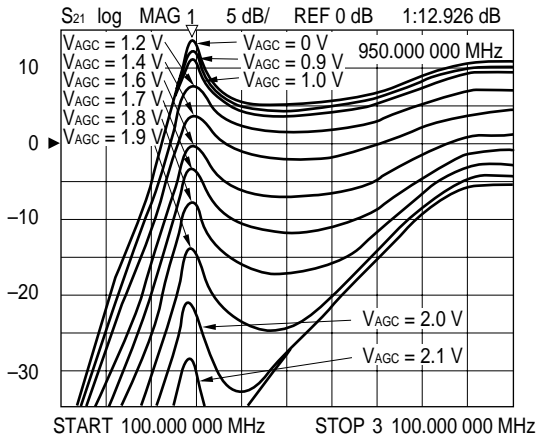

$S_{12}$  vs. FREQUENCY DEPENDENCE OF GAIN CONTROL VOLTAGE

$V_{CC} = 3.0$  V,  $P_{in} = -30$  dBm

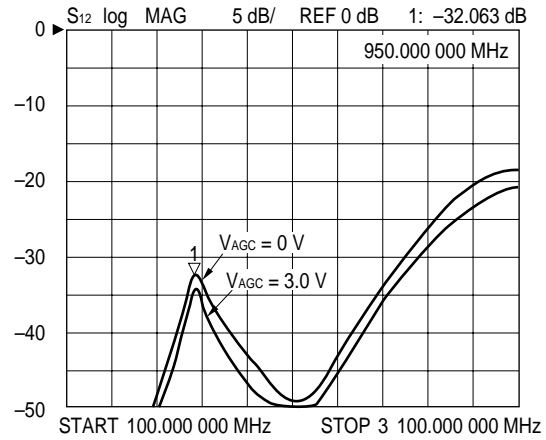

$S_{11}$  vs. FREQUENCY DEPENDENCE OF GAIN CONTROL VOLTAGE

$V_{CC} = 3.0$  V,  $P_{in} = -30$  dBm

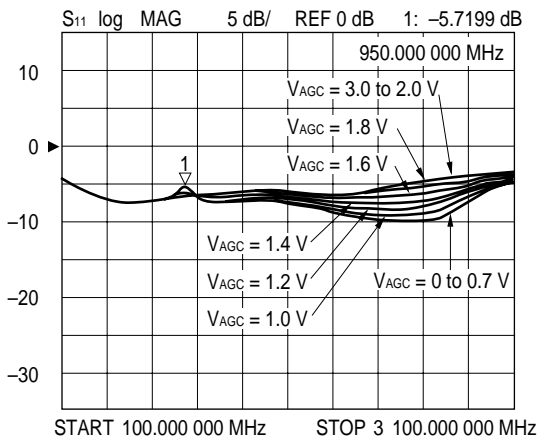

$S_{22}$  vs. FREQUENCY DEPENDENCE OF GAIN CONTROL VOLTAGE

$V_{CC} = 3.0$  V,  $P_{in} = -30$  dBm

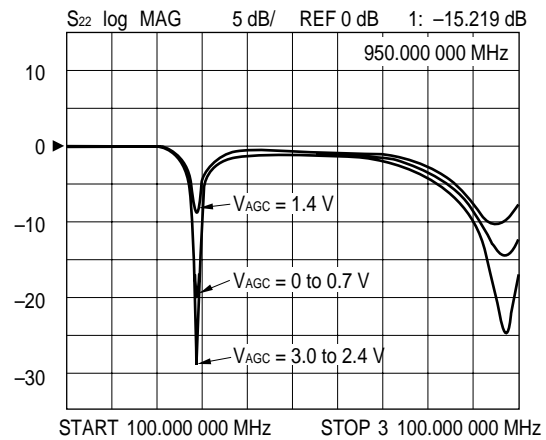

—  $\mu$ PC8119T —

Output port matching at  $f = 950$  MHz

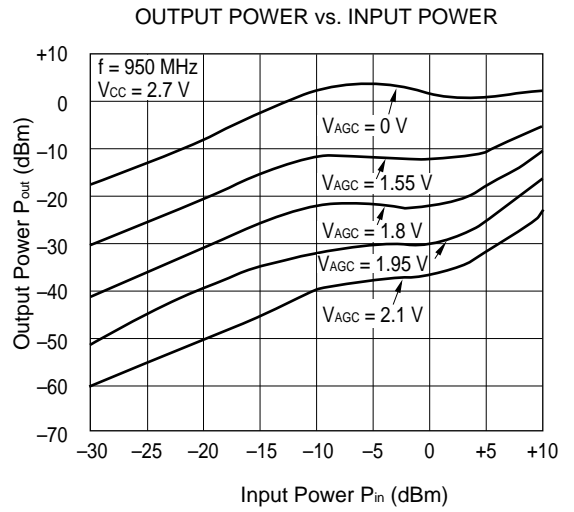
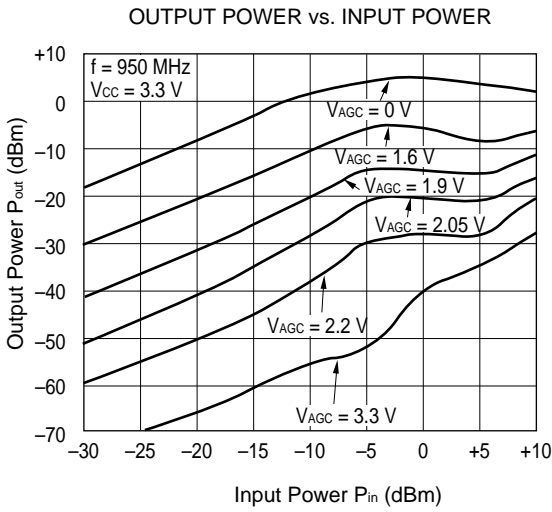
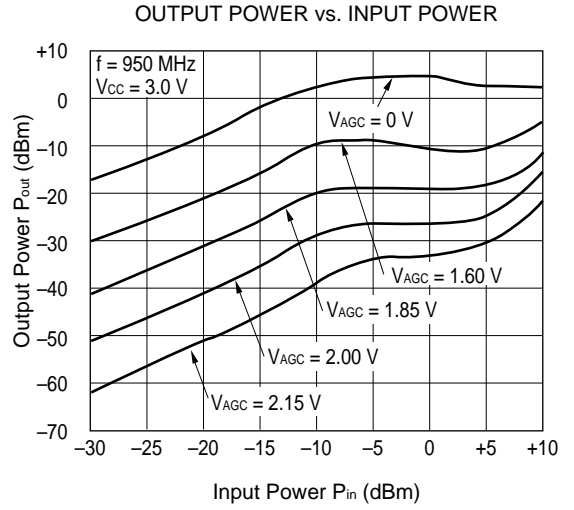
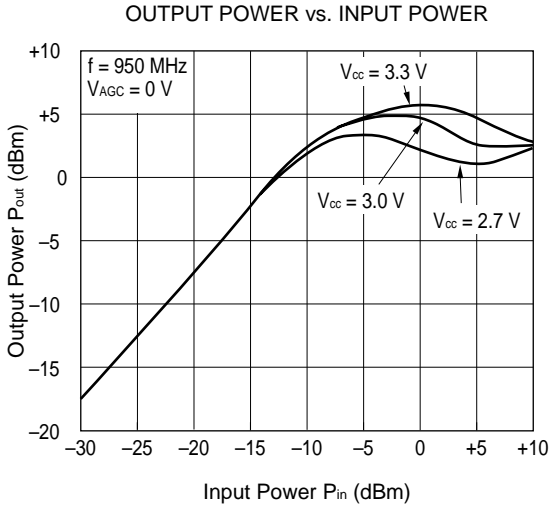

$\mu$ PC8119T

Output port matching at  $f = 950$  MHz

OUTPUT POWER AND IM<sub>3</sub> vs. INPUT POWER

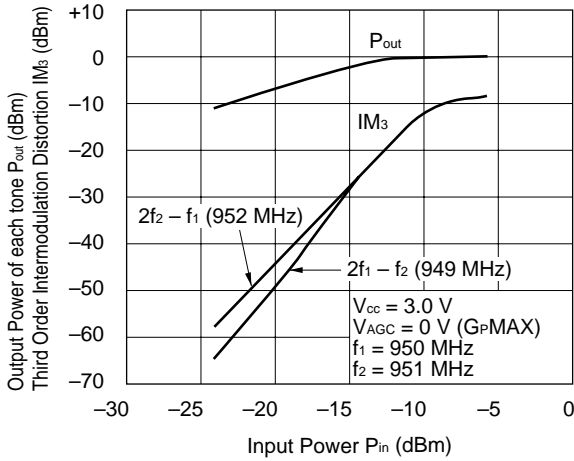

OUTPUT POWER AND IM<sub>3</sub> vs. INPUT POWER

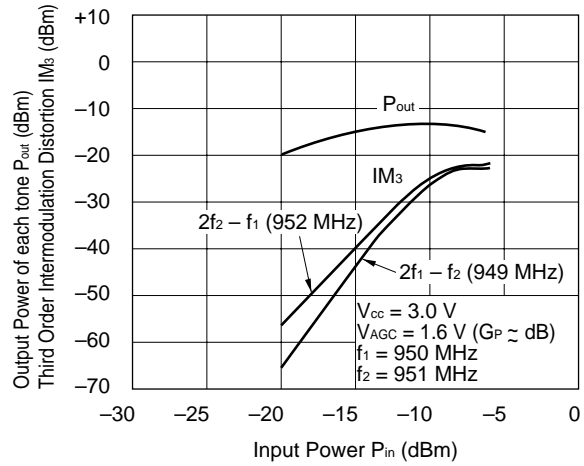

OUTPUT POWER AND IM<sub>3</sub> vs. INPUT POWER

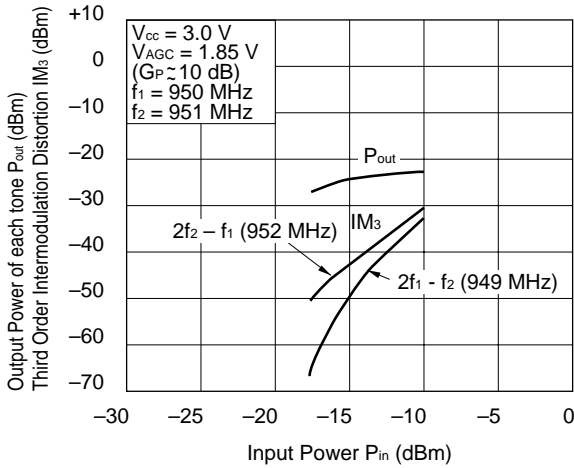

OUTPUT POWER AND IM<sub>3</sub> vs. INPUT POWER

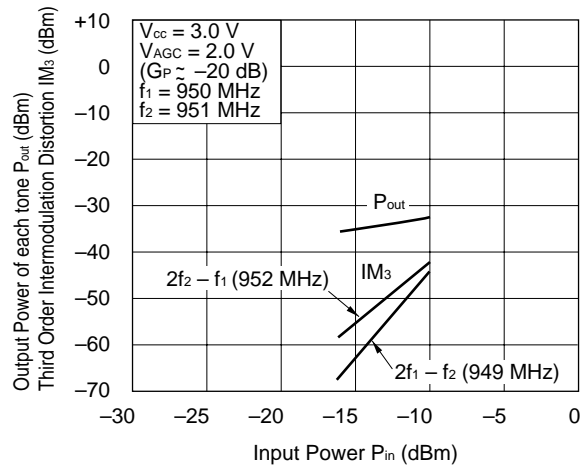

OUTPUT POWER AND IM<sub>3</sub> vs. INPUT POWER

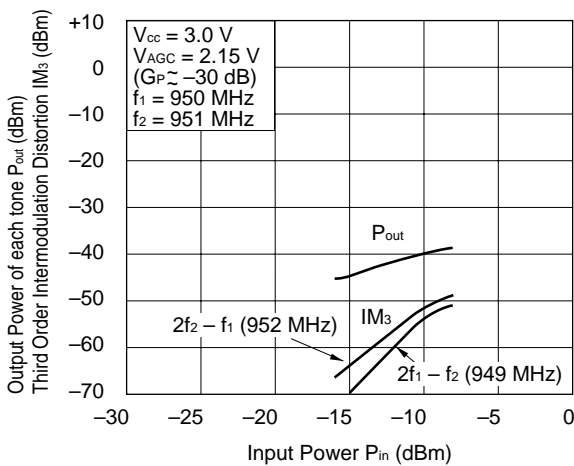

OUTPUT POWER AND IM<sub>3</sub> vs. INPUT POWER

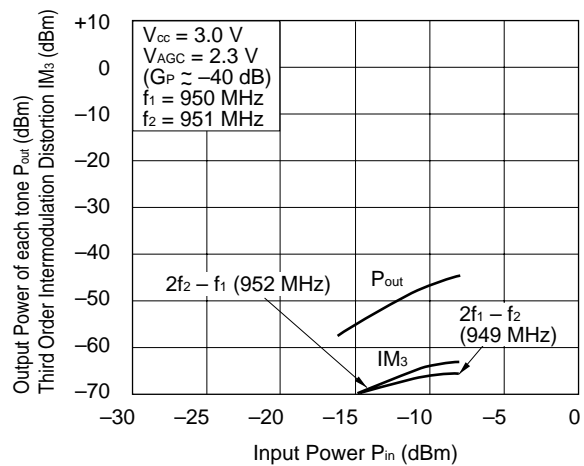



$\mu$ PC8119T

Output port matching at f = 950 MHz

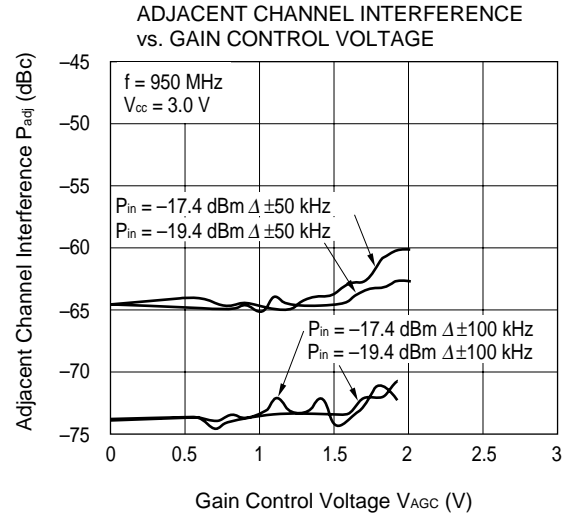
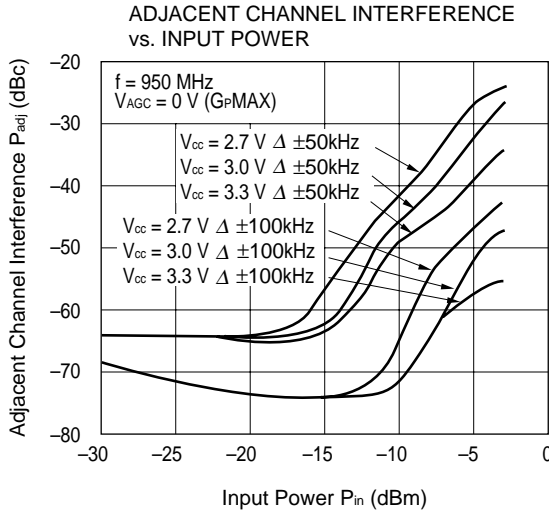
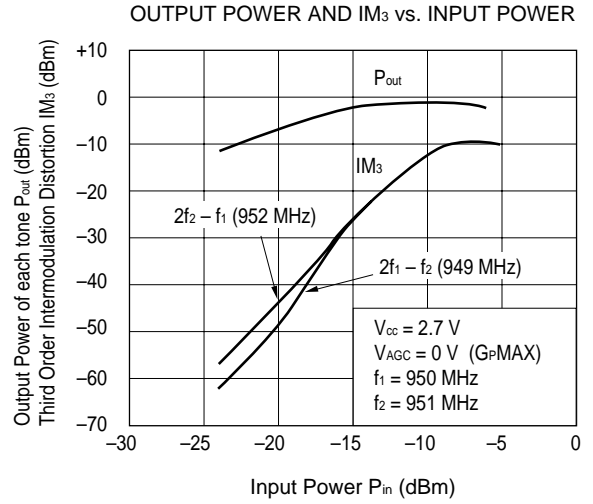
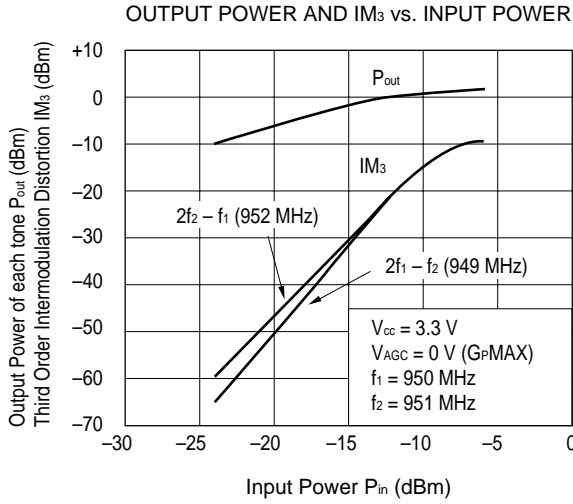

$\mu$ PC8119T

Output port matching at f = 1440 MHz

$V_{cc} = 3.0\text{ V}$ ,  $V_{AGC} = 0\text{ V}$  (G<sub>P</sub>MAX),  $P_{in} = -30\text{ dBm}$

S<sub>11</sub> vs. FREQUENCY 1; 36.172  $\Omega$  -45.977  $\Omega$  2.4039 pF  
1 440.000 000 MHz

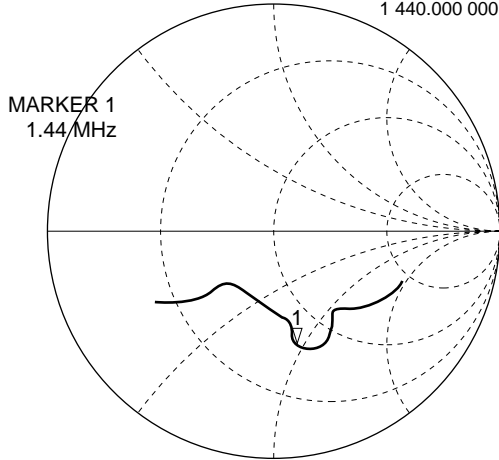

START 100.000 000 MHz STOP 3 100.000 000 MHz

S<sub>22</sub> vs. FREQUENCY 1; 48.932  $\Omega$  -13.582  $\Omega$  8.1375 pF  
1 440.000 000 MHz

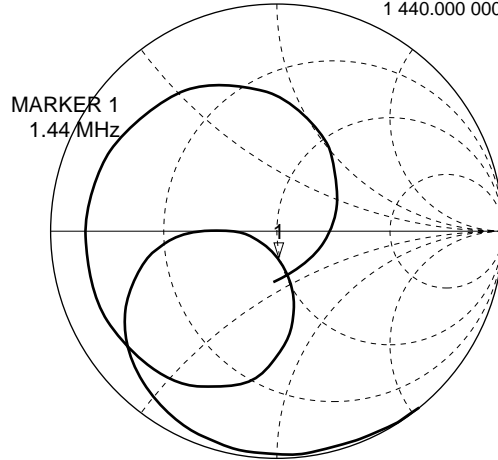

START 100.000 000 MHz STOP 3 100.000 000 MHz

S<sub>11</sub> vs. FREQUENCY

$V_{AGC} = 0\text{ V}$  (G<sub>P</sub>MAX),  $P_{in} = -30\text{ dBm}$

S<sub>11</sub> log MAG 5 dB/ REF 0 dB 1: -6.1588 dB

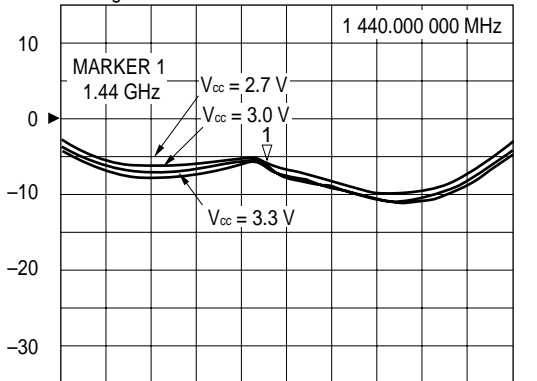

START 100.000 000 MHz STOP 3 100.000 000 MHz

S<sub>11</sub> vs. FREQUENCY

$V_{cc} = 3.0\text{ V}$ ,  $V_{AGC} = 0\text{ V}$  (G<sub>P</sub>MAX),  $P_{in} = -30\text{ dBm}$

S<sub>11</sub> log MAG 5 dB/ REF 0 dB 1: -6.2593 dB

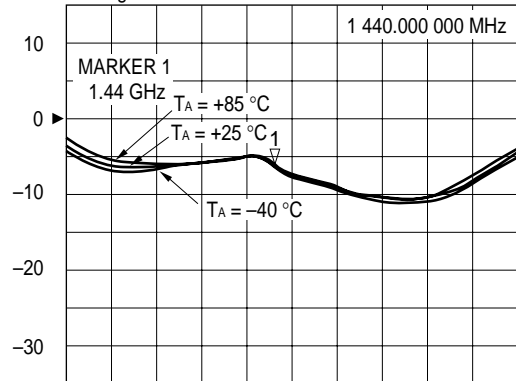

START 100.000 000 MHz STOP 3 100.000 000 MHz

S<sub>22</sub> vs. FREQUENCY

$V_{AGC} = 0\text{ V}$  (G<sub>P</sub>MAX),  $P_{in} = -30\text{ dBm}$

S<sub>22</sub> log MAG 5 dB/ REF 0 dB 1: -17.51 dB

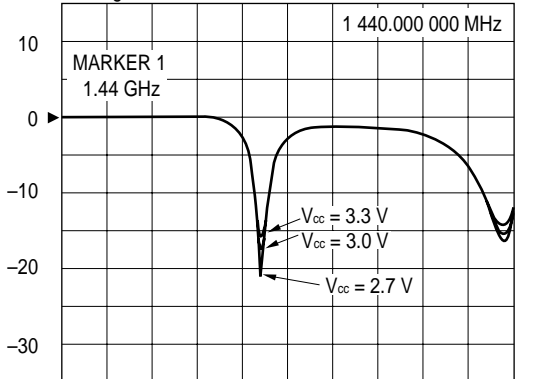

START 100.000 000 MHz STOP 3 100.000 000 MHz

S<sub>22</sub> vs. FREQUENCY

$V_{cc} = 3.0\text{ V}$ ,  $V_{AGC} = 0\text{ V}$  (G<sub>P</sub>MAX),  $P_{in} = -30\text{ dBm}$

S<sub>22</sub> log MAG 5 dB/ REF 0 dB 1: -16.978 dB

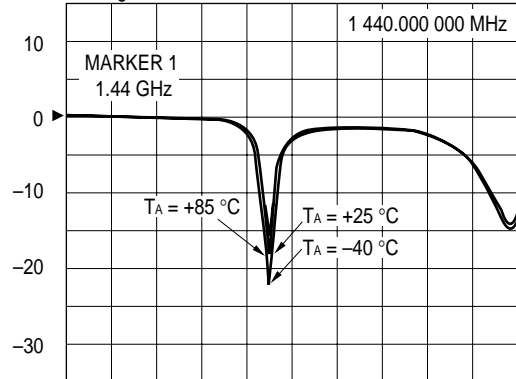

START 100.000 000 MHz STOP 3 100.000 000 MHz

$\mu$ PC8119T

Output port matching at f = 1440 MHz

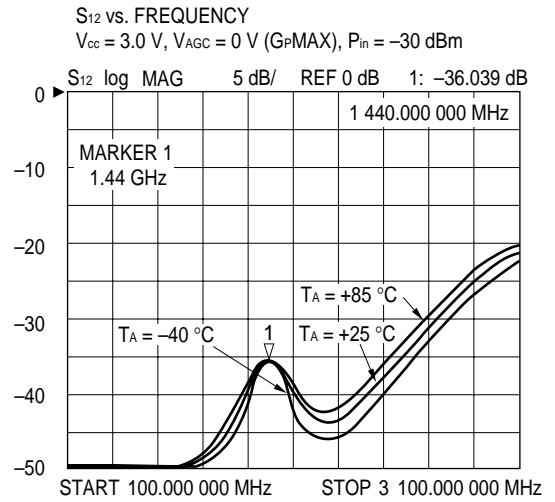
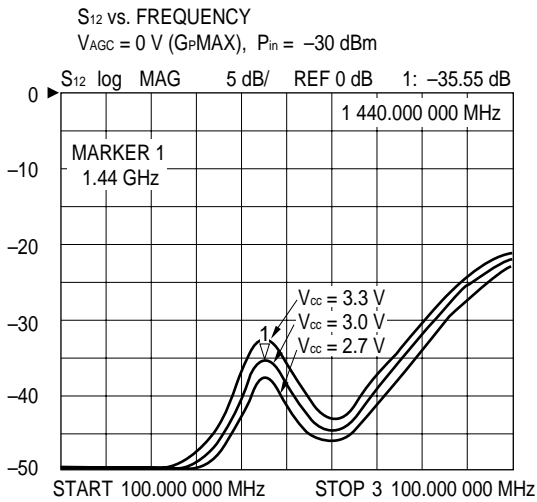
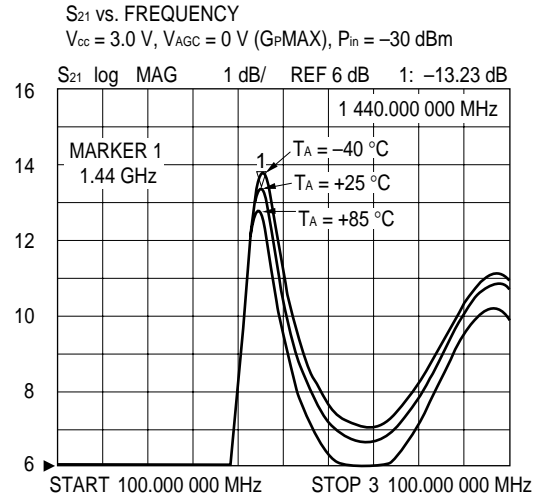
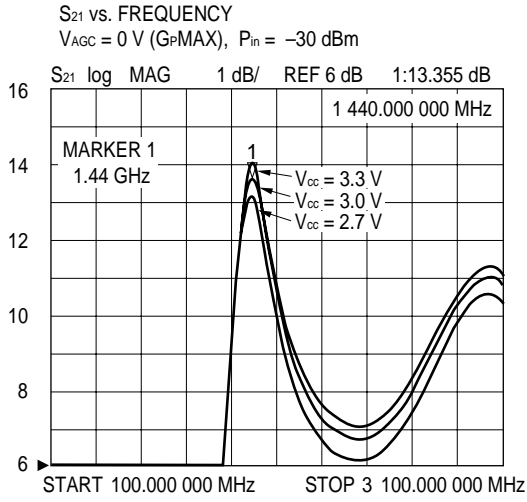

$\mu$ PC8119T

Output port matching at f = 1440 MHz

POWER GAIN vs. GAIN CONTROL VOLTAGE

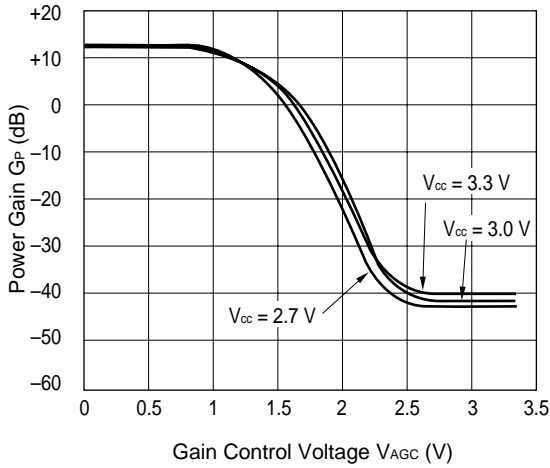

POWER GAIN vs. GAIN CONTROL VOLTAGE

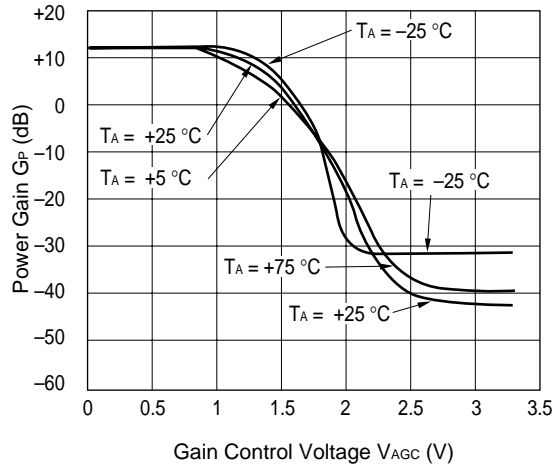

$S_{21}$  vs. FREQUENCY DEPENDENCE OF GAIN CONTROL VOLTAGE  
 $V_{cc} = 3.0\text{ V}$ ,  $P_{in} = -30\text{ dBm}$

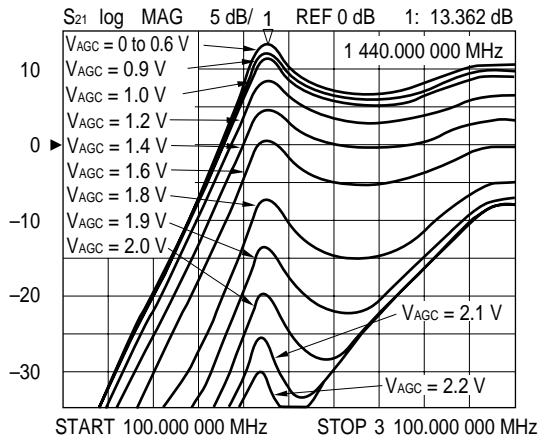

$S_{12}$  vs. FREQUENCY DEPENDENCE OF GAIN CONTROL VOLTAGE  
 $V_{cc} = 3.0\text{ V}$ ,  $P_{in} = -30\text{ dBm}$

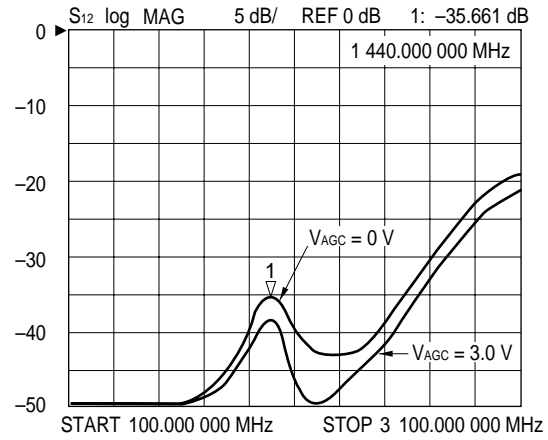

$S_{11}$  vs. FREQUENCY DEPENDENCE OF GAIN CONTROL VOLTAGE  
 $V_{cc} = 3.0\text{ V}$ ,  $P_{in} = -30\text{ dBm}$

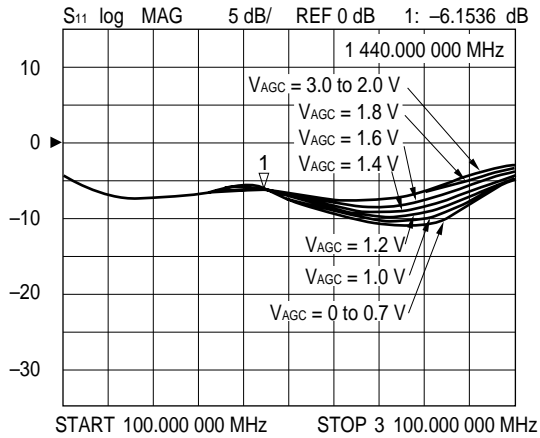

$S_{22}$  vs. FREQUENCY DEPENDENCE OF GAIN CONTROL VOLTAGE  
 $V_{cc} = 3.0\text{ V}$ ,  $P_{in} = -30\text{ dBm}$

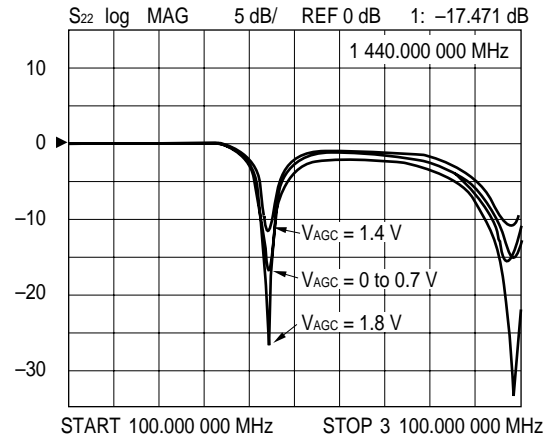

—  $\mu$ PC8119T —

Output port matching at  $f = 1440$  MHz

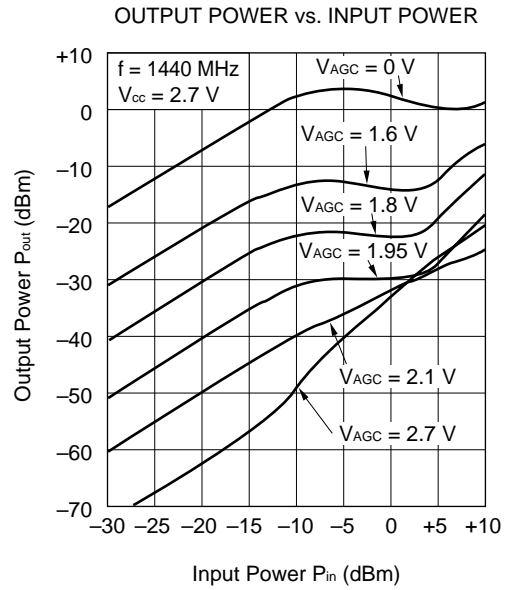
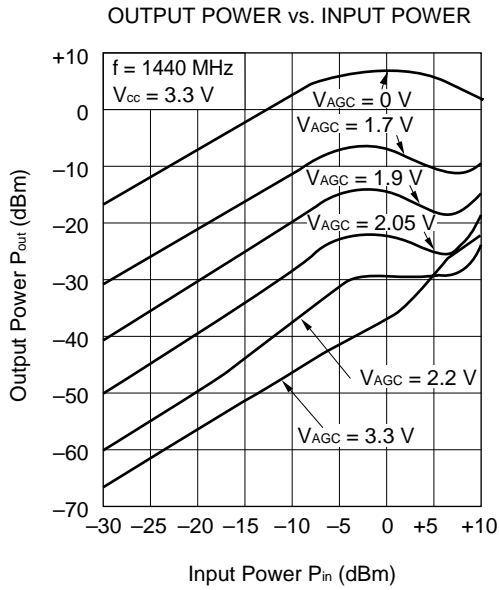
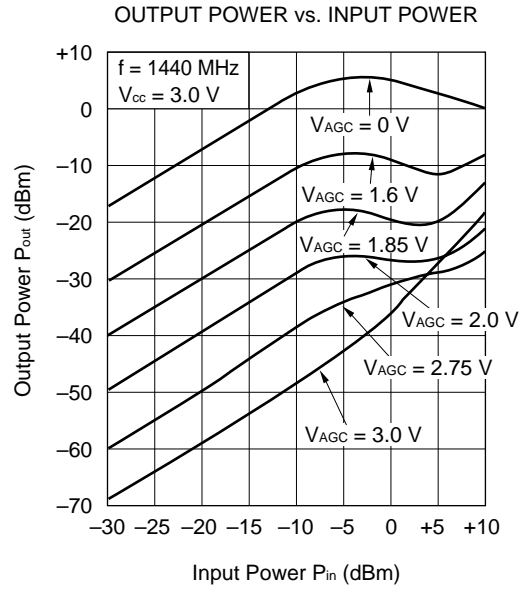
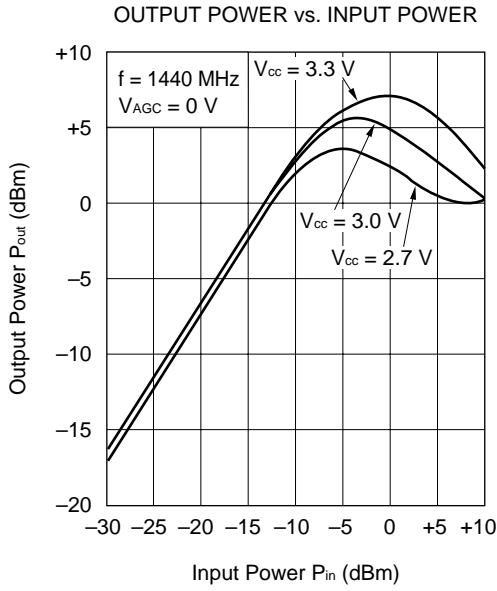

$\mu$ PC8119T

Output port matching at  $f = 1440$  MHz

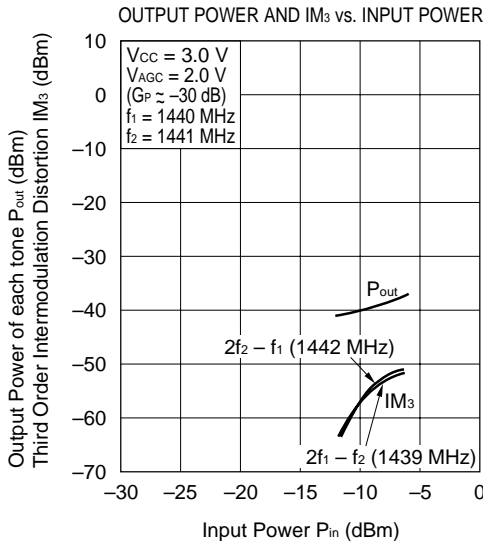
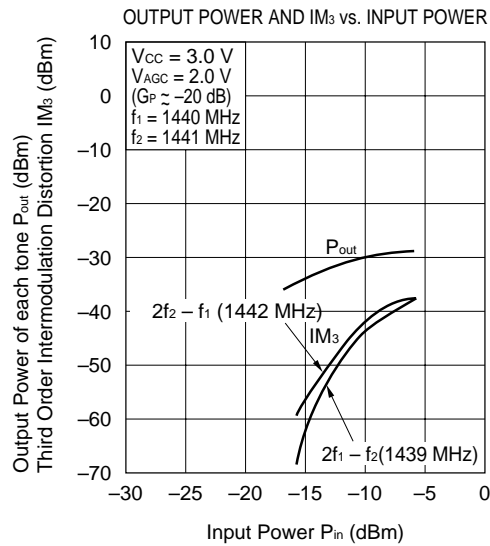
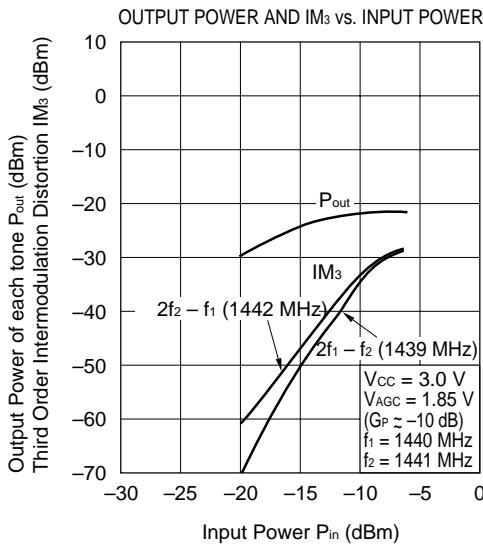
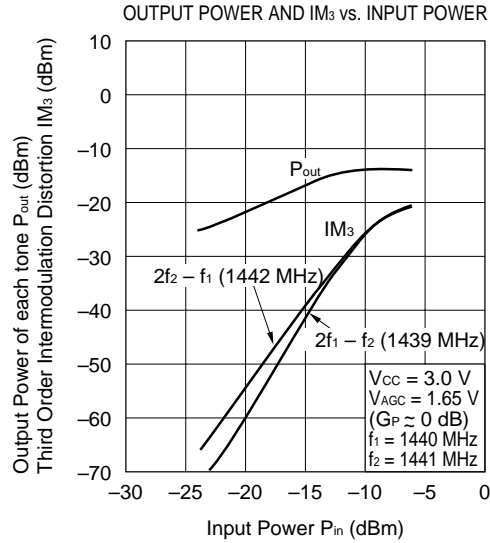
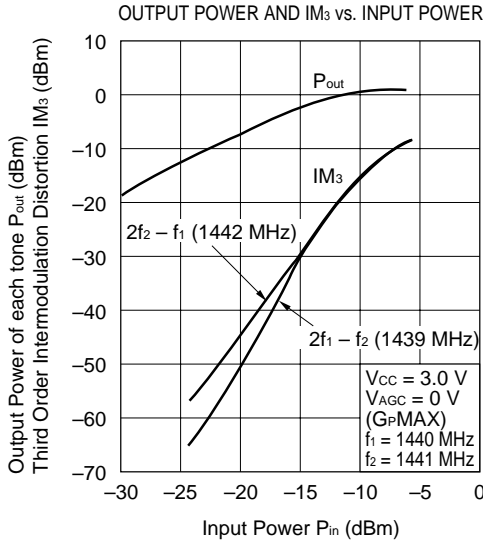

—  $\mu$ PC8119T —

Output port matching at  $f = 1440$  MHz

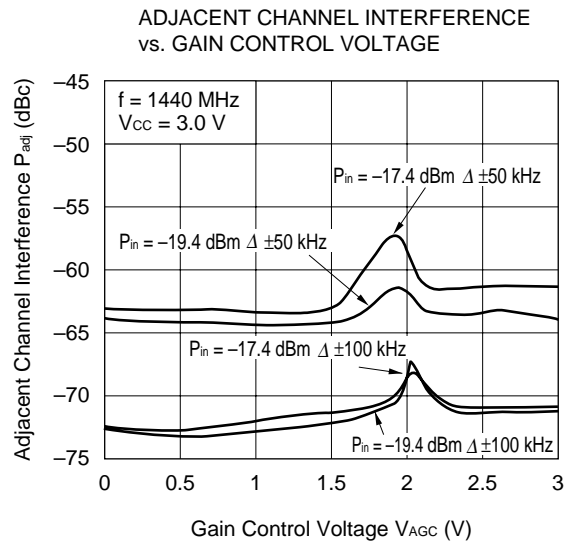
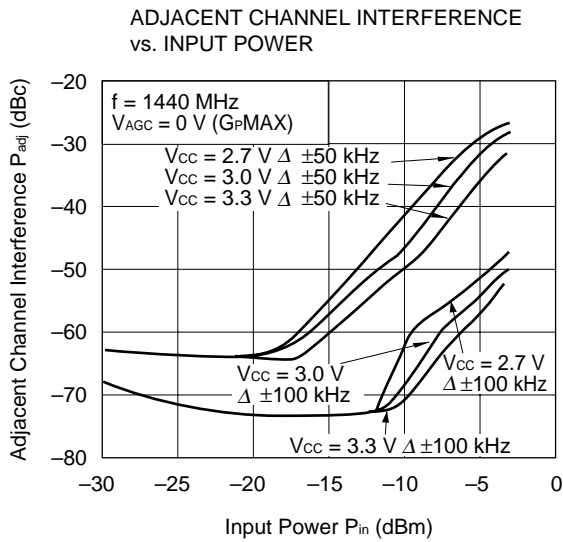
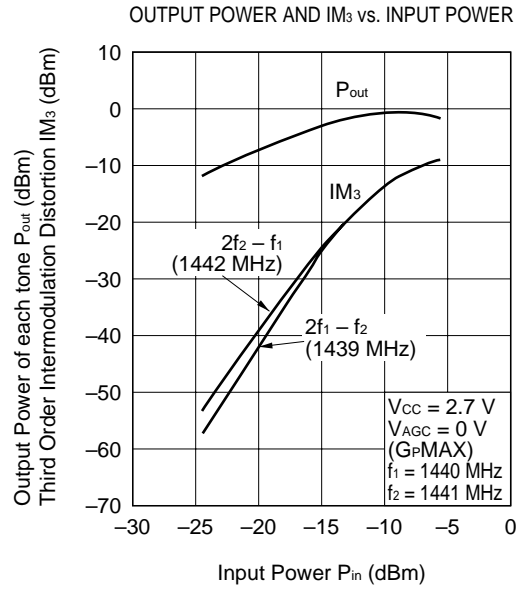
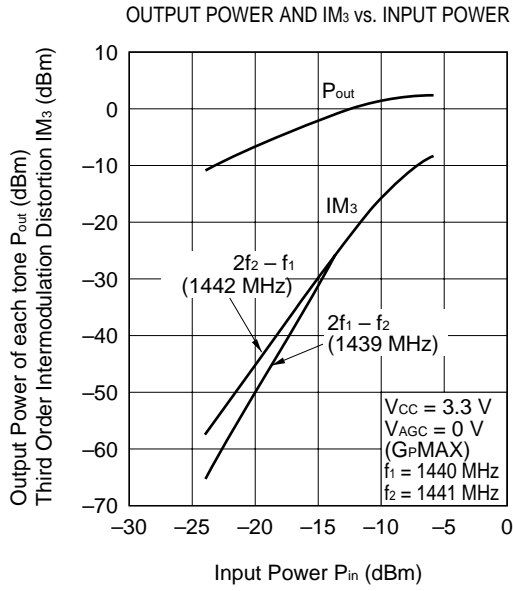

$\mu$ PC8119T

Output port matching at  $f = 1900$  MHz

$V_{CC} = V_{out} = 3.0$  V,  $V_{AGC} = 0$  V (GpMAX),  $P_{in} = -30$  dBm

S11 vs. FREQUENCY 1; 25.644  $\Omega$  -28.377  $\Omega$  2.9519 pF  
1 900.000 000 MHz

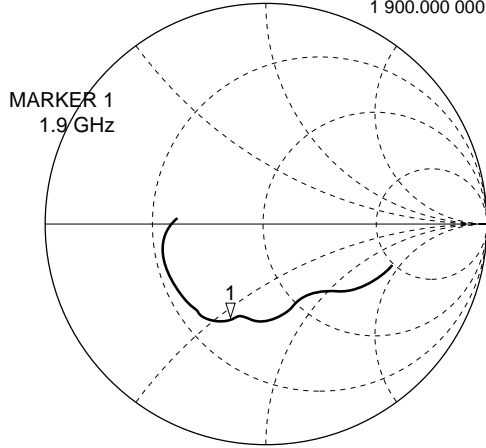

START 100.000 000 MHz STOP 3 100.000 000 MHz

S22 vs. FREQUENCY 1; 43.631  $\Omega$  8.0605  $\Omega$  675.2 pF  
1 900.000 000 MHz

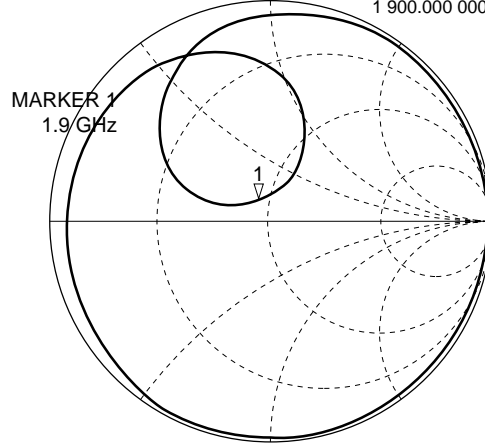

START 100.000 000 MHz STOP 3 100.000 000 MHz

S11 vs. FREQUENCY  
 $V_{AGC} = 0$  V (GpMAX),  $P_{in} = -30$  dBm

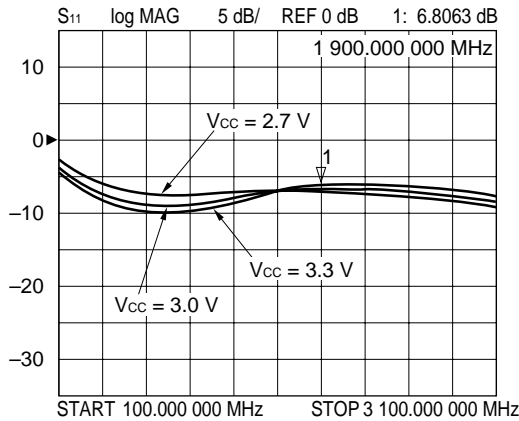

S22 vs. FREQUENCY  
 $V_{AGC} = 0$  V (GpMAX),  $P_{in} = -30$  dBm

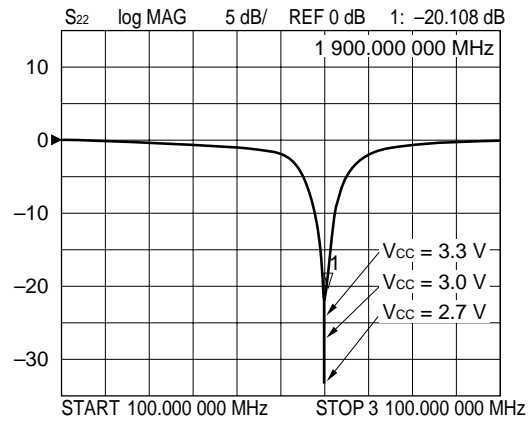

S21 vs. FREQUENCY  
 $V_{AGC} = 0$  V (GpMAX),  $P_{in} = -30$  dBm

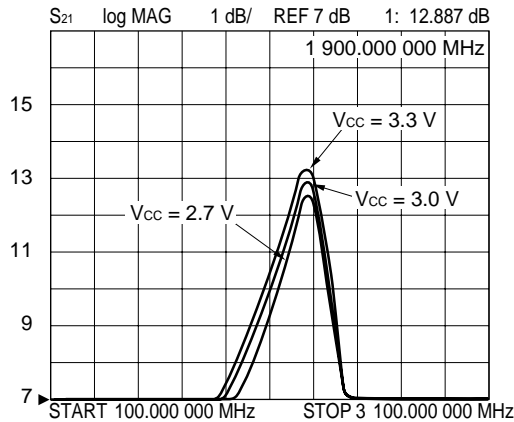

S12 vs. FREQUENCY  
 $V_{AGC} = 0$  V (GpMAX),  $P_{in} = -30$  dBm

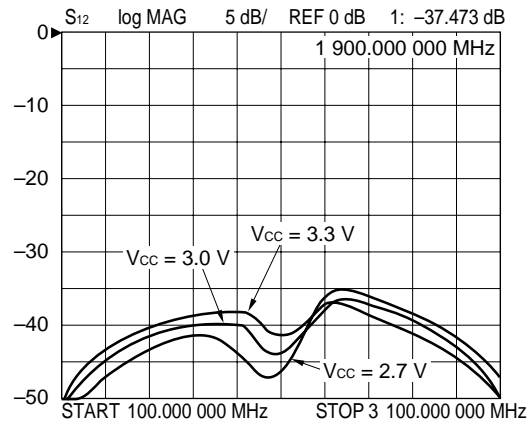



$\mu$ PC8119T

Output port matching at f = 1900 MHz

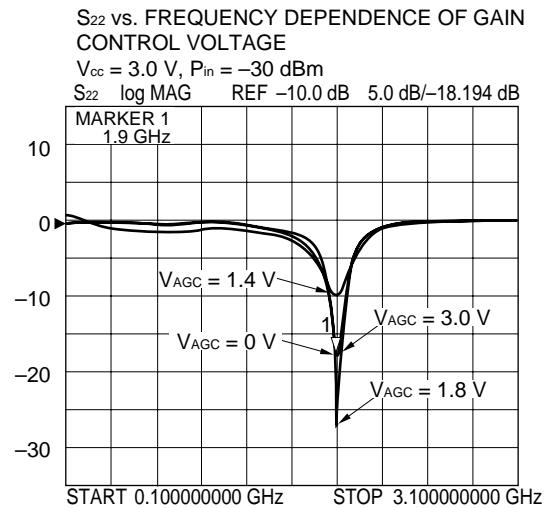
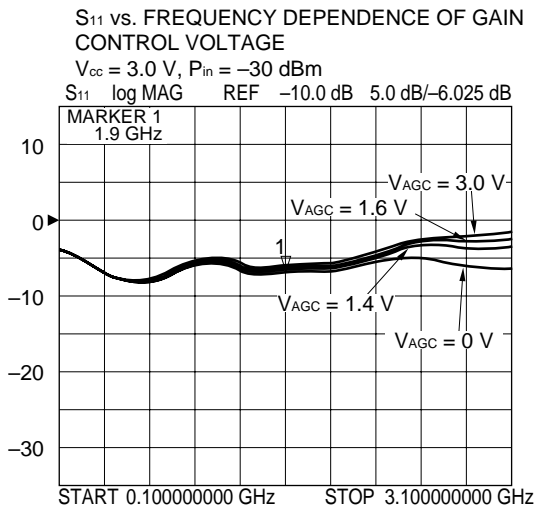
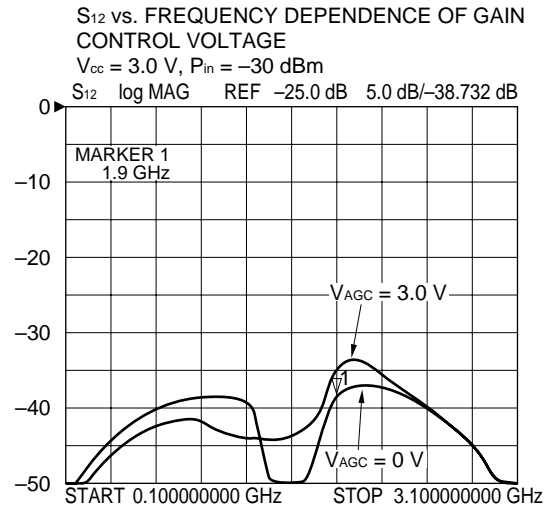
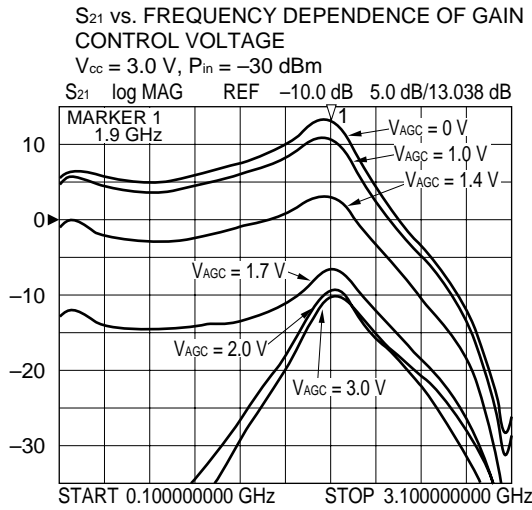
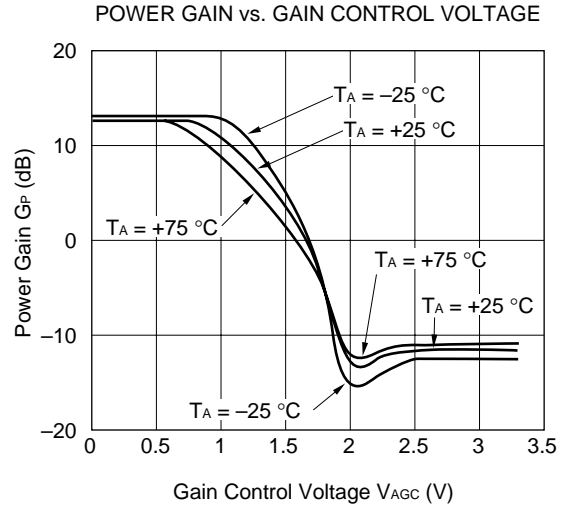
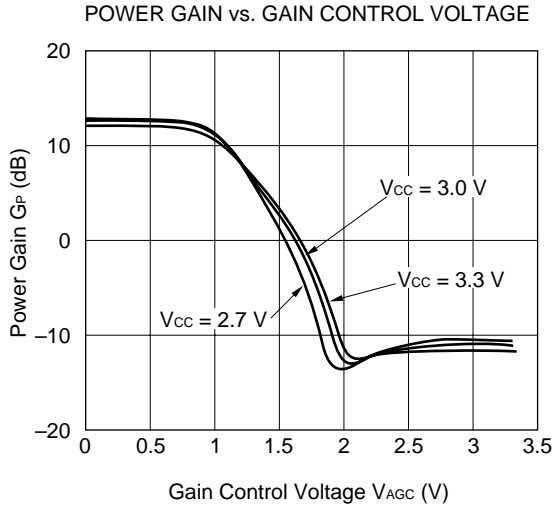

$\mu$ PC8119T

Output port matching at f = 1900 MHz

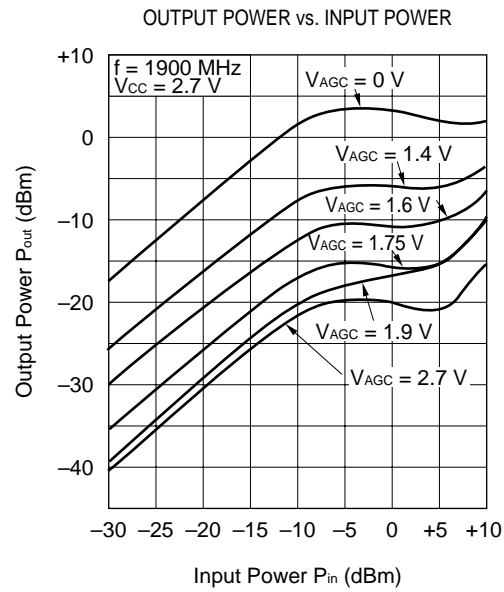
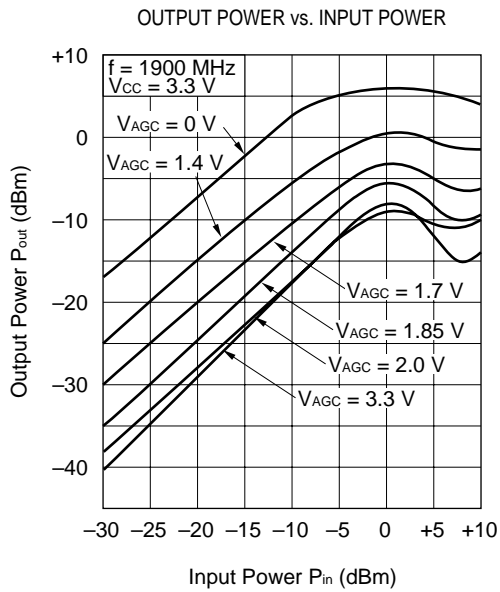
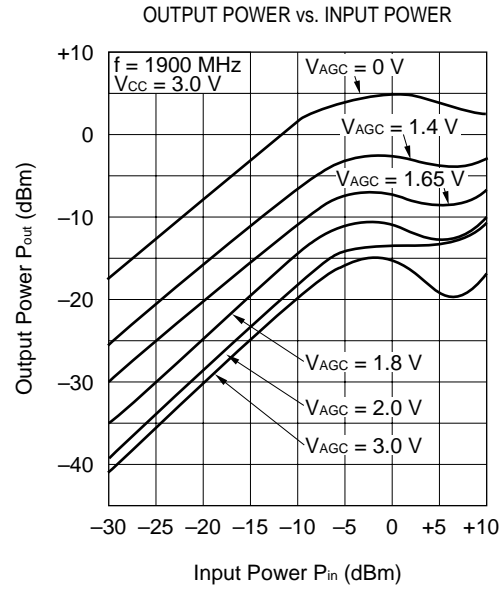
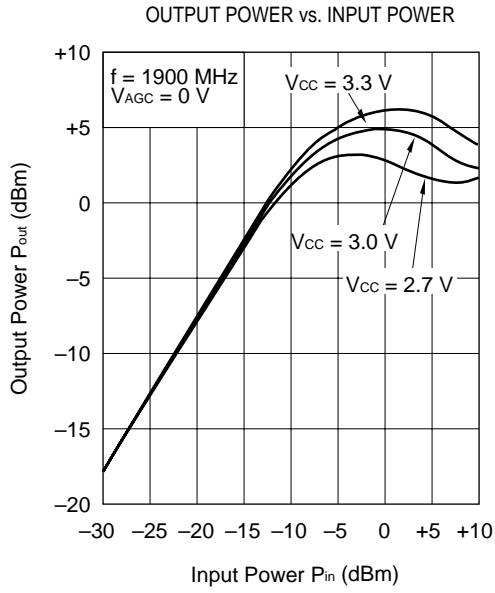

—  $\mu$ PC8119T —

Output port matching at  $f = 1900$  MHz

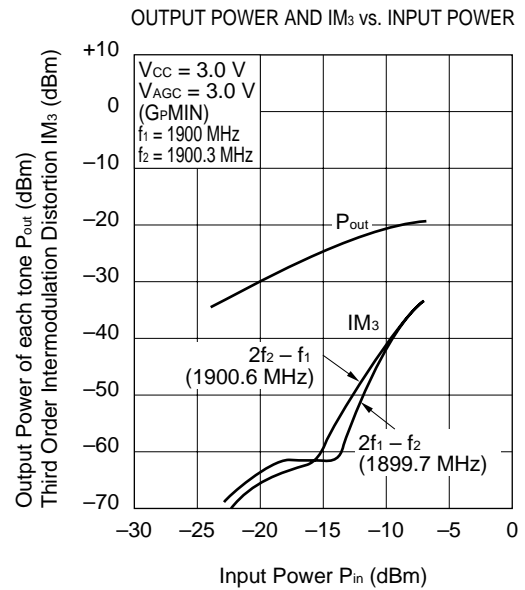
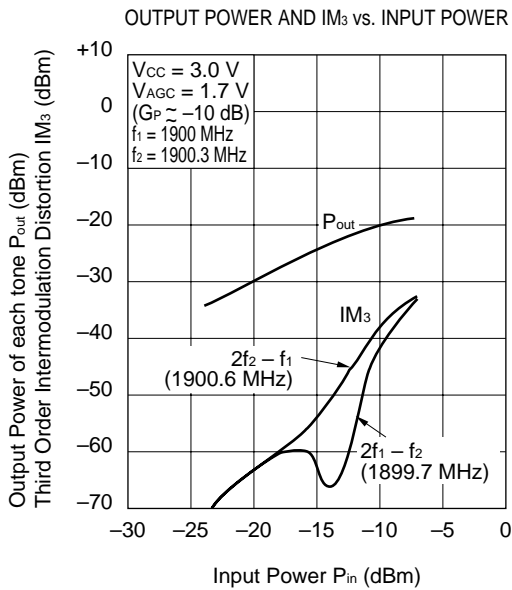
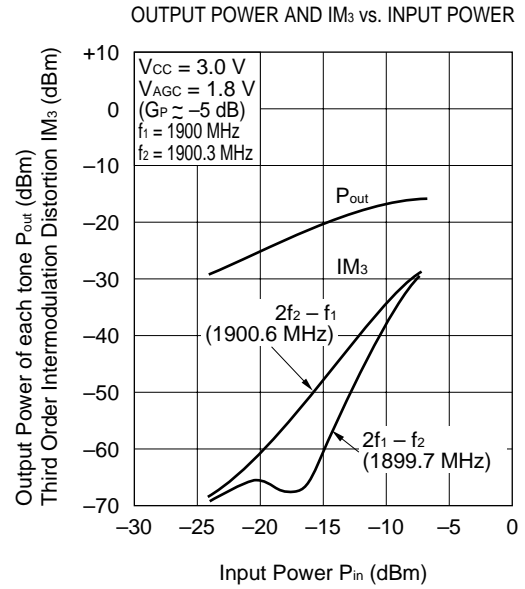
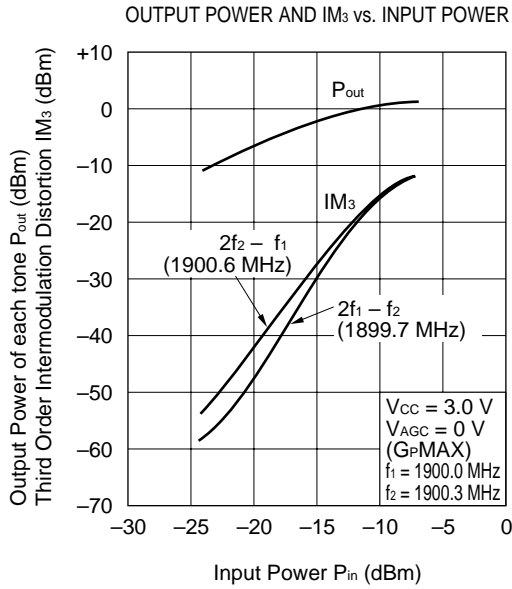

$\mu$ PC8119T

Output port matching at f = 1900 MHz

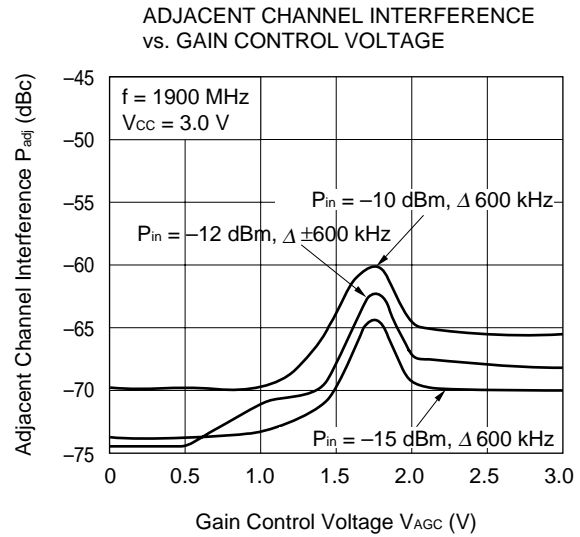
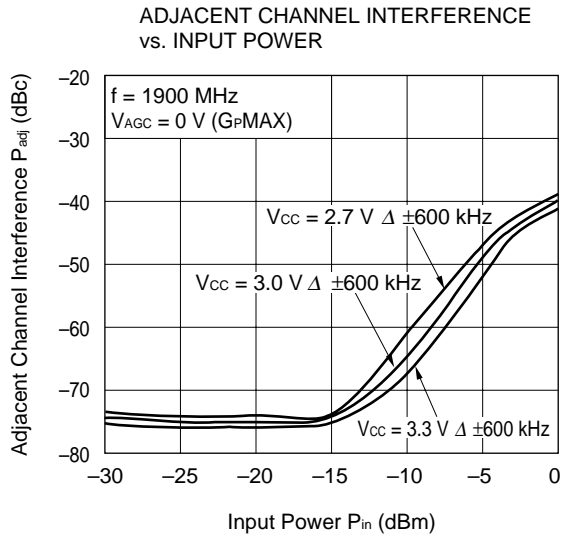
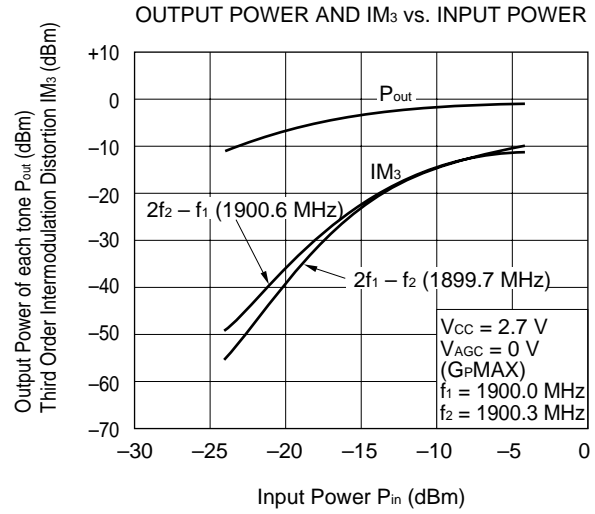
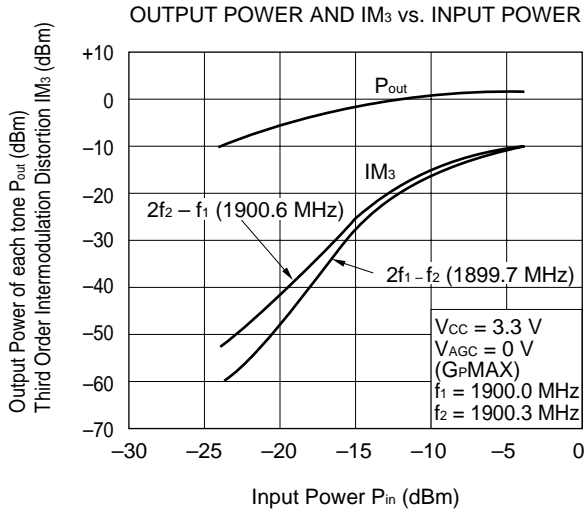

$\mu$ PC8120T

CIRCUIT CURRENT vs. SUPPLY VOLTAGE

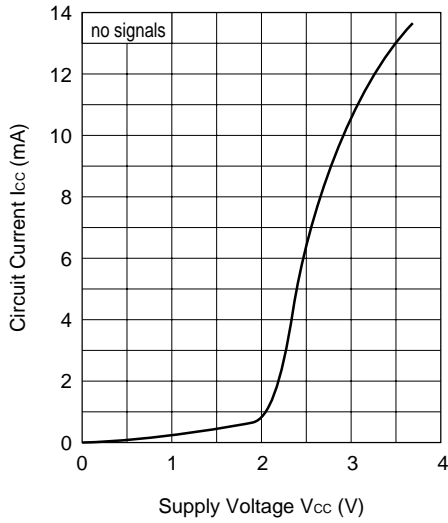

GAIN CONTROL CURRENT vs. GAIN CONTROL VOLTAGE

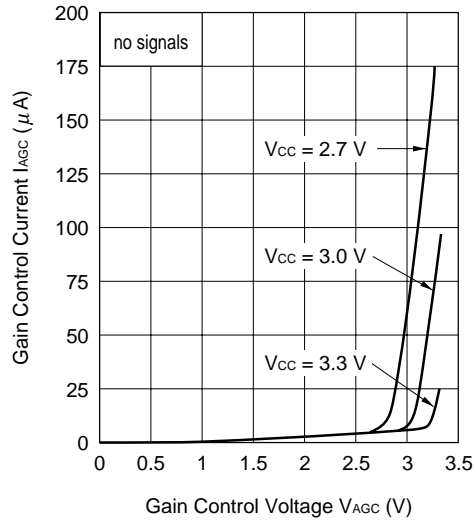

CIRCUIT CURRENT vs. OPERATING AMBIENT TEMPERATURE

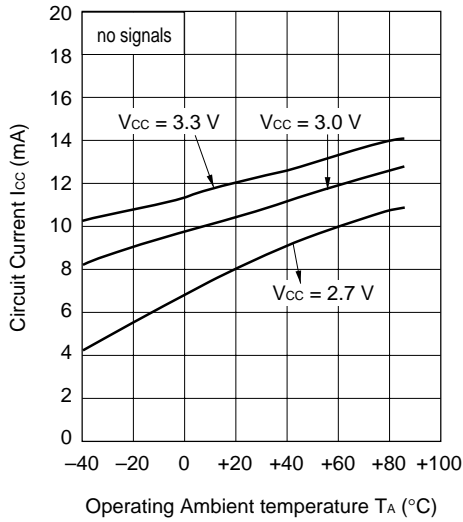

CURRENT INTO OUTPUT PIN AND CURRENT INTO Vcc PIN vs. GAIN CONTROL VOLTAGE

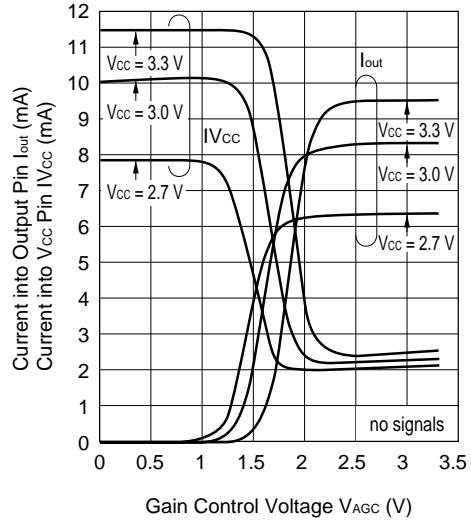

S11 vs. FREQUENCY  
Vcc = 3.0 V, Vagc = 3.0 V (GpMAX), Pin = -30 dBm

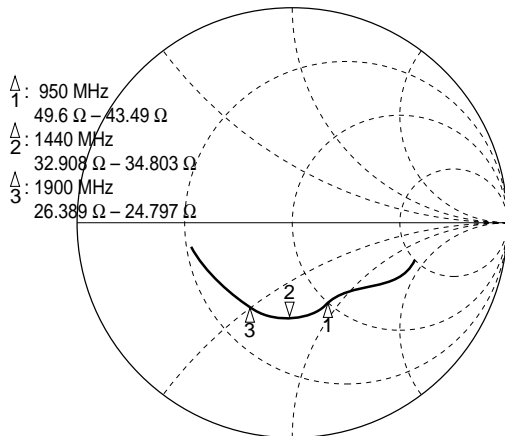

START 100.000 000 MHz STOP 3 100.000 000 MHz

S22 vs. FREQUENCY  
Vcc = 3.0 V, Vagc = 3.0 V (GpMAX), Pin = -30 dBm

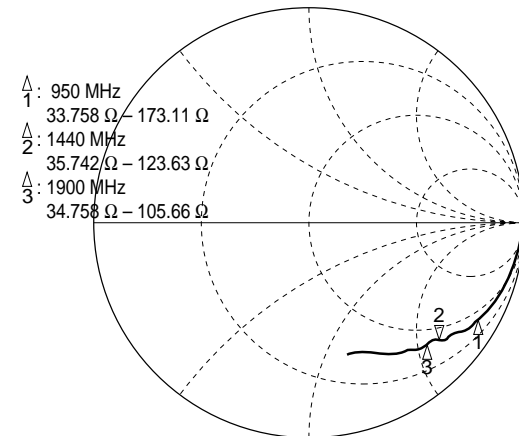

START 100.000 000 MHz STOP 3 100.000 000 MHz

$\mu$ PC8120T

Output port matching at f = 950 MHz

$V_{CC} = 3.0\text{ V}$ ,  $V_{AGC} = 3.0\text{ V}$  (G<sub>P</sub>MAX),  $P_{in} = -30\text{ dBm}$   
 $S_{11}$  vs. FREQUENCY 1; 42.344  $\Omega$  -55.41  $\Omega$  3.0235 pF  
 950.000.000 MHz

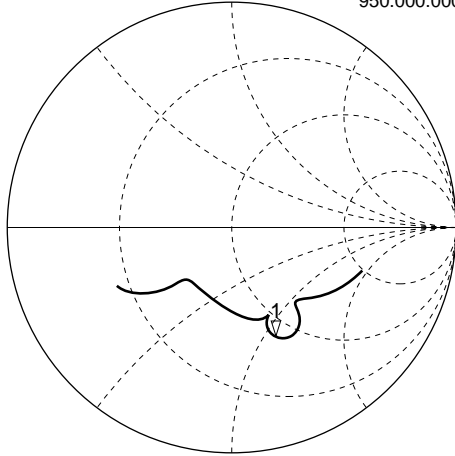

START 100.000 000 MHz STOP 3 100.000 000 MHz

$S_{22}$  vs. FREQUENCY 1; 50.91  $\Omega$  -5.9805  $\Omega$  28.013 pF  
 950.000 000 MHz

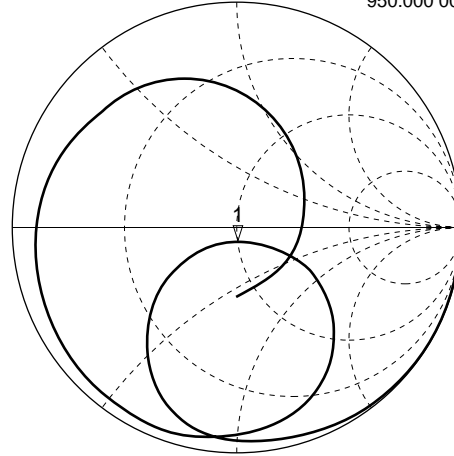

START 100.000 000 MHz STOP 3 100.000 000 MHz

$S_{11}$  vs. FREQUENCY  
 $V_{AGC} = 3.0\text{ V}$  (G<sub>P</sub>MAX),  $P_{in} = -30\text{ dBm}$   
 $S_{11}$  log MAG 5dB/ REF 0 dB 1: -5.6328 dB  
 950.000 000 MHz

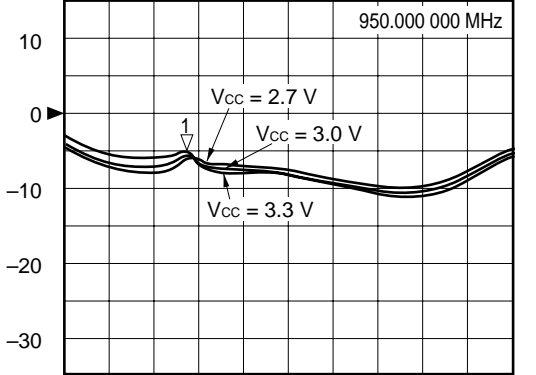

START 100.000 000 MHz STOP 3 100.000 000 MHz

$S_{11}$  vs. FREQUENCY  
 $V_{CC} = 3.0\text{ V}$ ,  $V_{AGC} = 3.0\text{ V}$  (G<sub>P</sub>MAX),  $P_{in} = -30\text{ dBm}$   
 $S_{11}$  log MAG 5dB/ REF 0 dB 1: -5.7196 dB  
 950.000 000 MHz

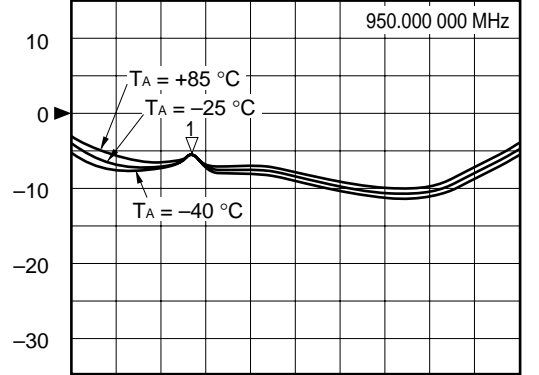

START 100.000 000 MHz STOP 3 100.000 000 MHz

$S_{22}$  vs. FREQUENCY  
 $V_{AGC} = 3.0\text{ V}$  (G<sub>P</sub>MAX),  $P_{in} = -30\text{ dBm}$   
 $S_{22}$  log MAG 5dB/ REF 0 dB 1: -19.447 dB  
 950.000 000 MHz

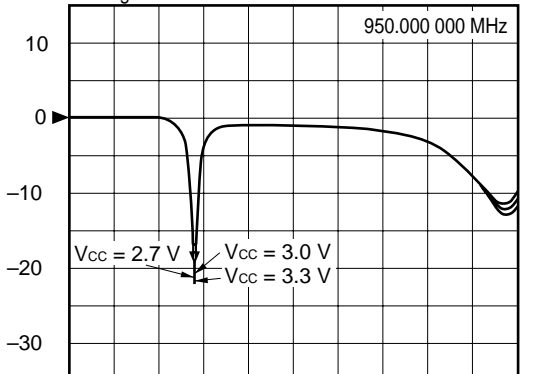

START 100.000 000 MHz STOP 3 100.000 000 MHz

$S_{22}$  vs. FREQUENCY  
 $V_{CC} = 3.0\text{ V}$ ,  $V_{AGC} = 3.0\text{ V}$  (G<sub>P</sub>MAX),  $P_{in} = -30\text{ dBm}$   
 $S_{22}$  log MAG 5dB/ REF 0 dB 1: -18.205 dB  
 950.000 000 MHz

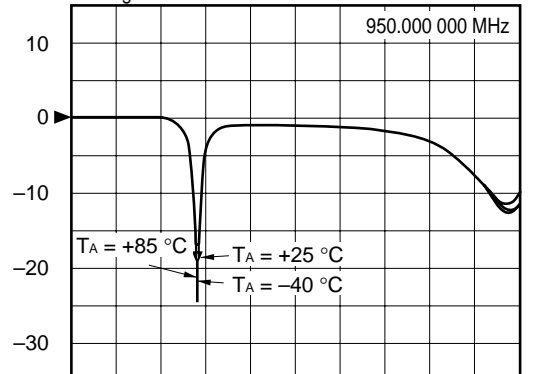

START 100.000 000 MHz STOP 3 100.000 000 MHz

—  $\mu$ PC8120T —

Output port matching at  $f = 950$  MHz

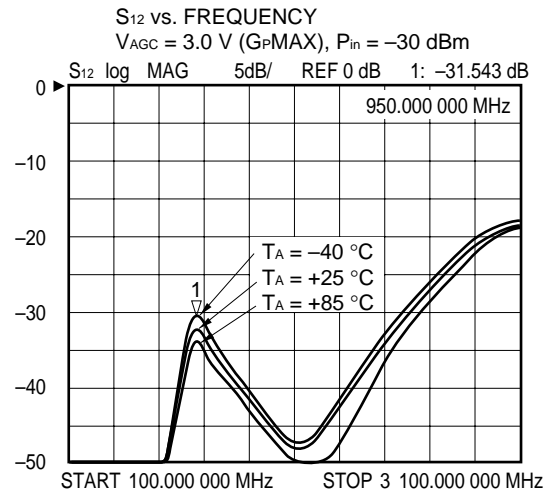
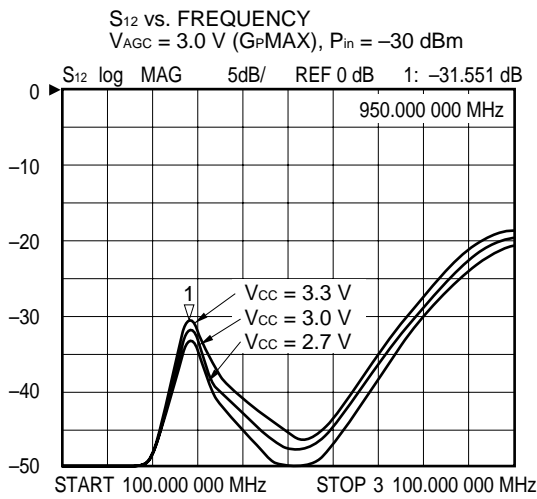
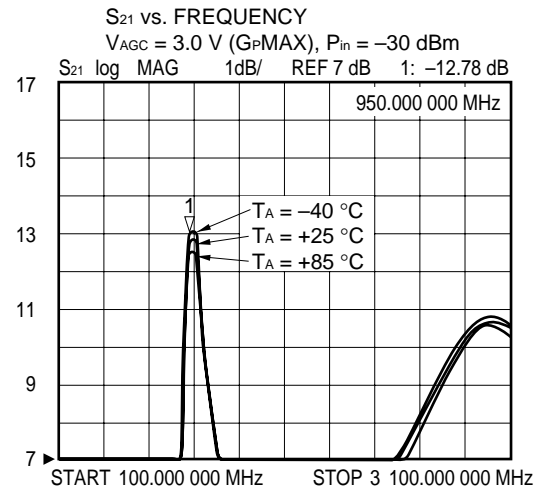
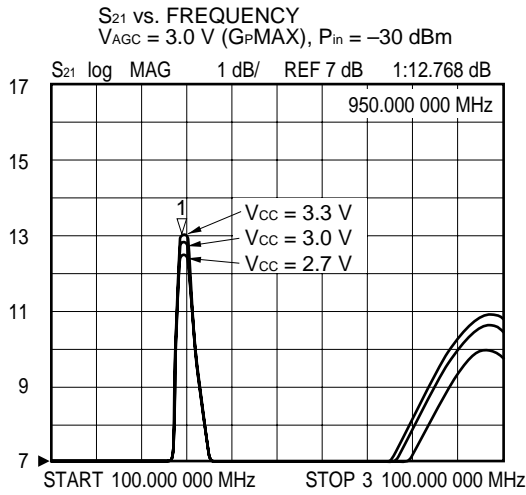

$\mu$ PC8120T

Output port matching at f = 950 MHz

POWER GAIN vs. GAIN CONTROL VOLTAGE

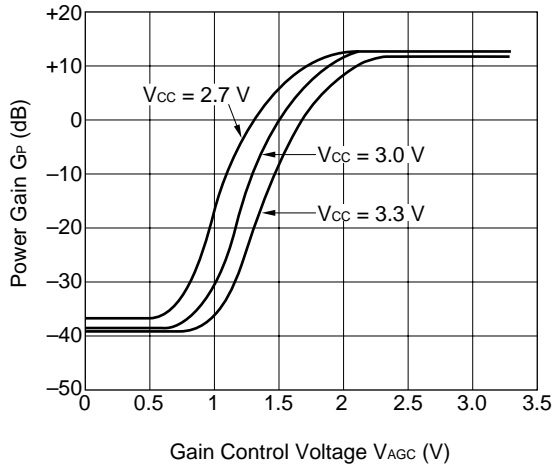

POWER GAIN vs. GAIN CONTROL VOLTAGE

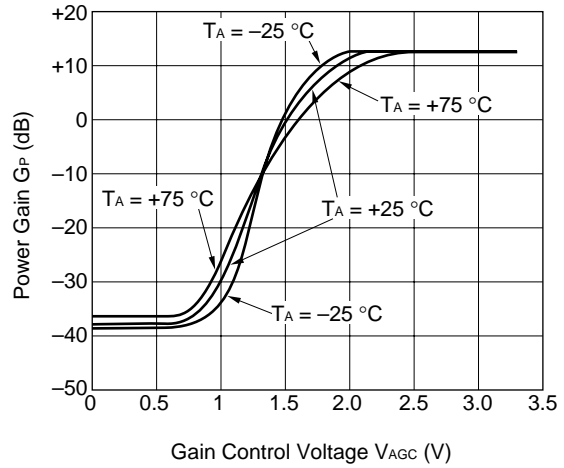

$S_{21}$  vs. FREQUENCY DEPENDENCE OF GAIN CONTROL VOLTAGE  
 $V_{CC} = 3.0\text{ V}$ ,  $P_{in} = -30\text{ dBm}$

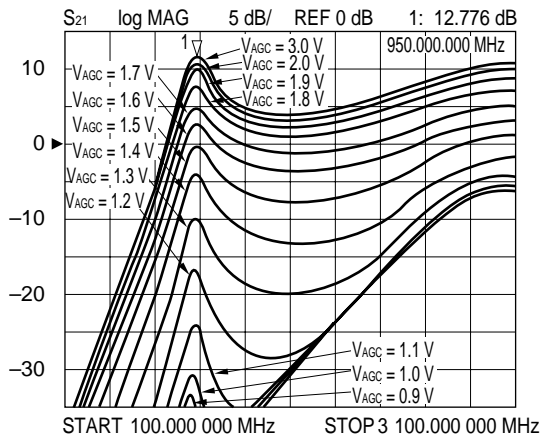

$S_{12}$  vs. FREQUENCY DEPENDENCE OF GAIN CONTROL VOLTAGE  
 $V_{CC} = 3.0\text{ V}$ ,  $P_{in} = -30\text{ dBm}$

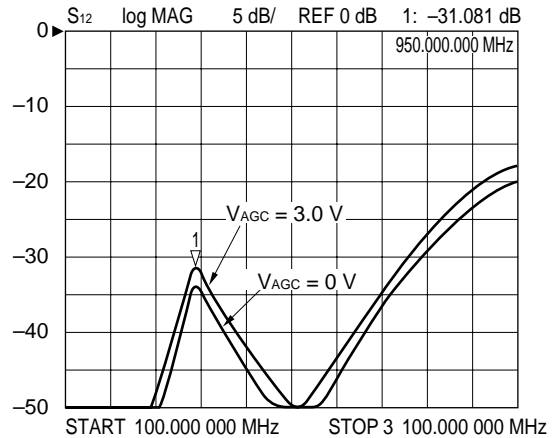

$S_{11}$  vs. FREQUENCY DEPENDENCE OF GAIN CONTROL VOLTAGE  
 $V_{CC} = 3.0\text{ V}$ ,  $P_{in} = -30\text{ dBm}$

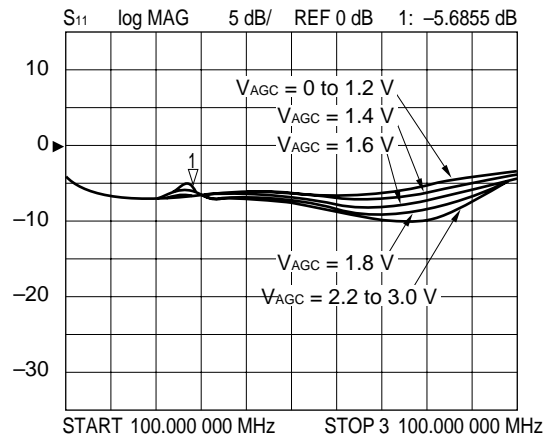

$S_{22}$  vs. FREQUENCY DEPENDENCE OF GAIN CONTROL VOLTAGE  
 $V_{CC} = 3.0\text{ V}$ ,  $P_{in} = -30\text{ dBm}$

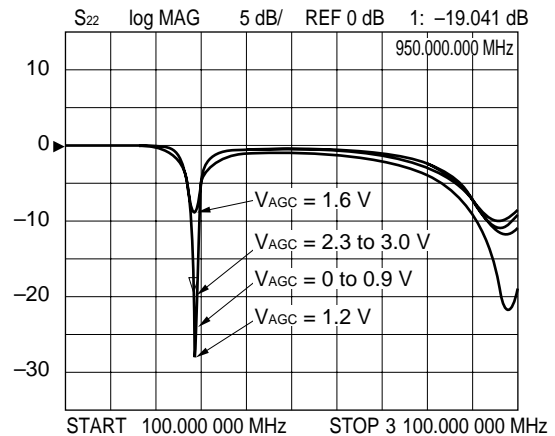



—  $\mu$ PC8120T —

Output port matching at  $f = 950$  MHz

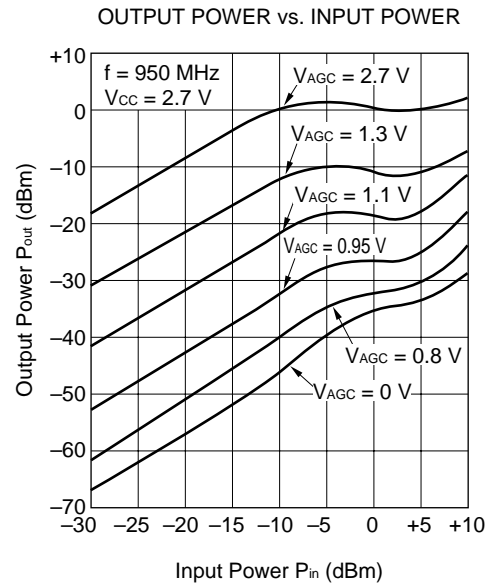
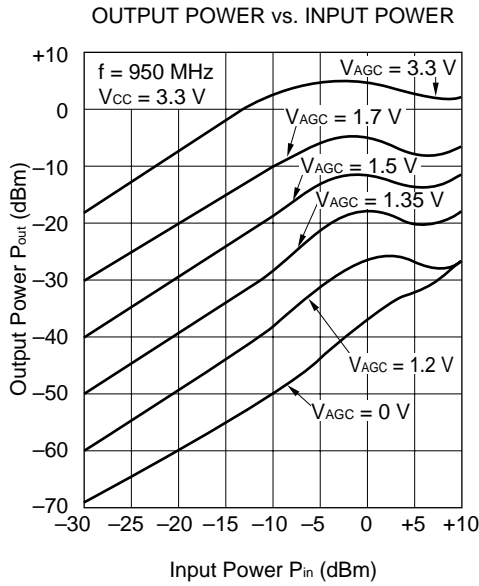
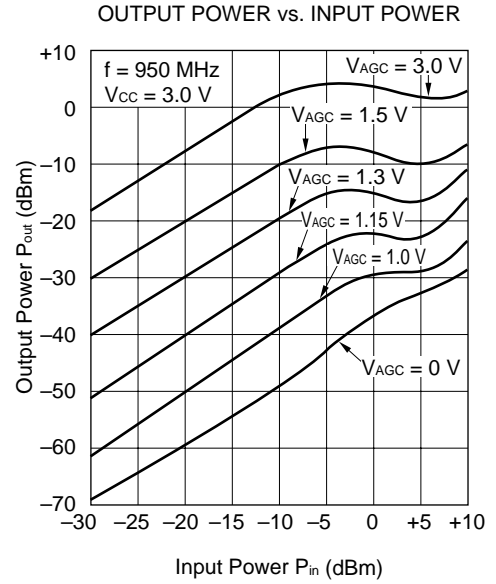
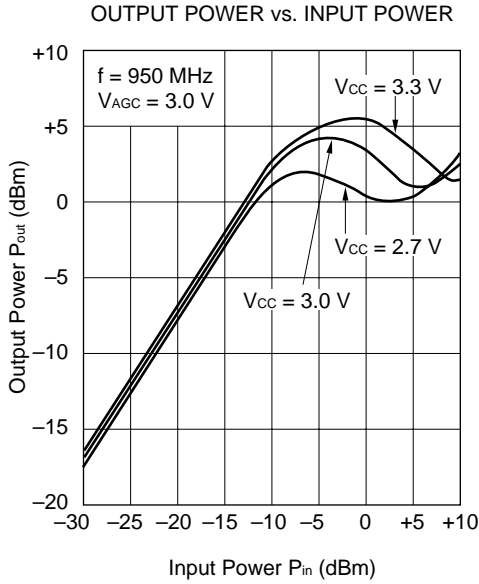

$\mu$ PC8120T

Output port matching at f = 950 MHz

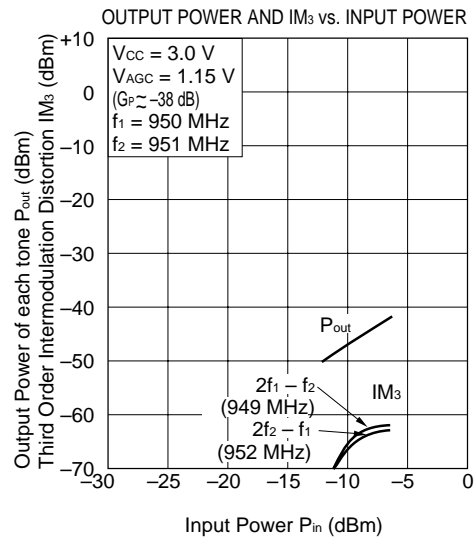
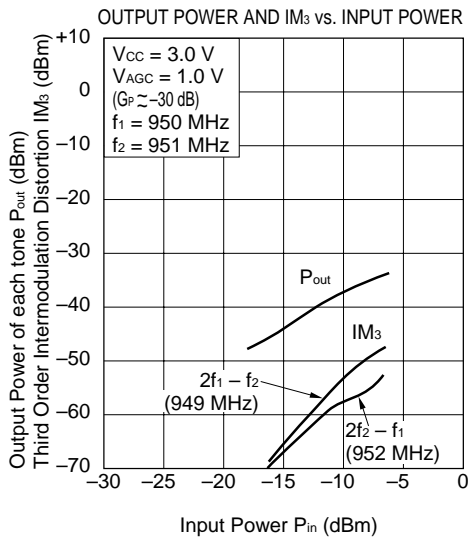
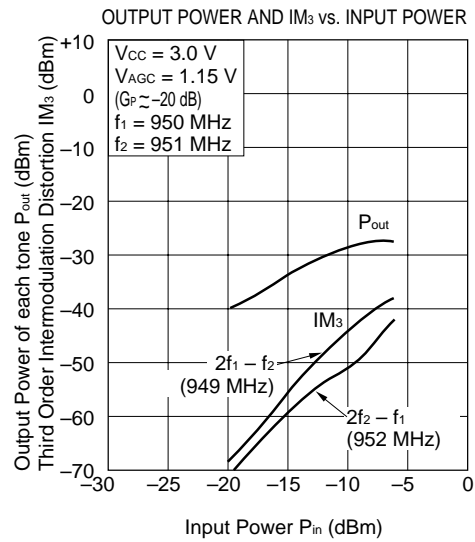
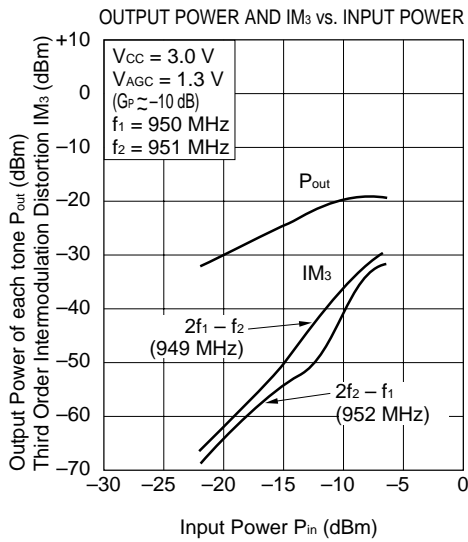
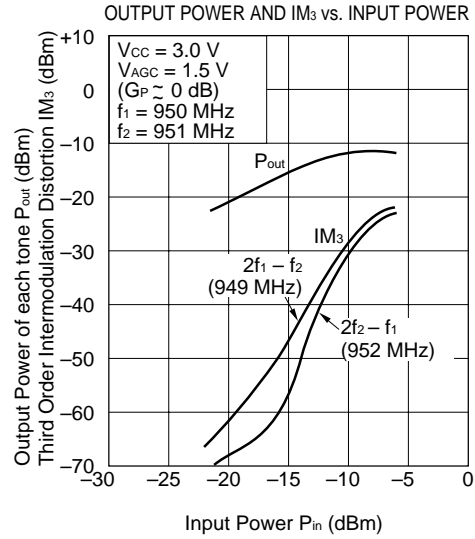
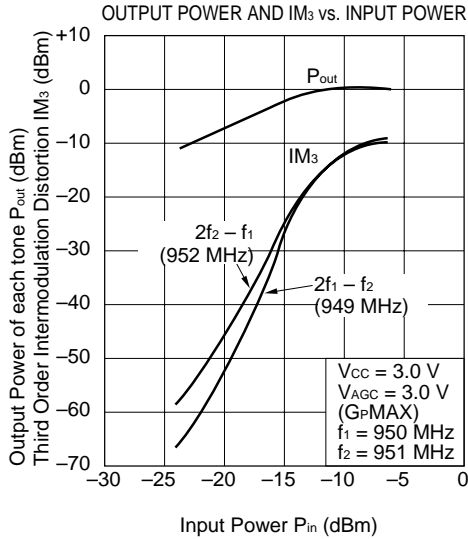

$\mu$ PC8120T

Output port matching at  $f = 950$  MHz

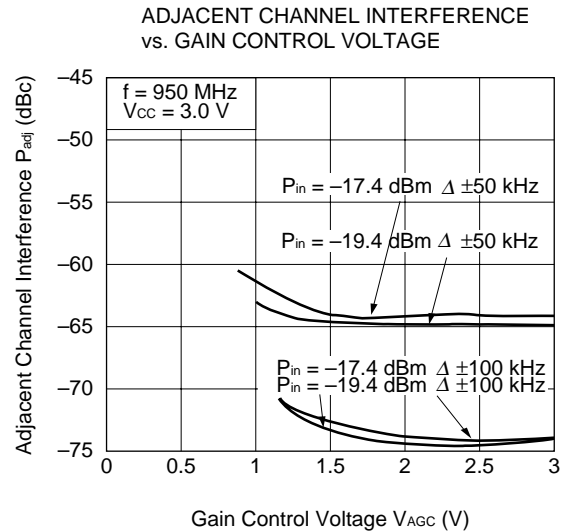
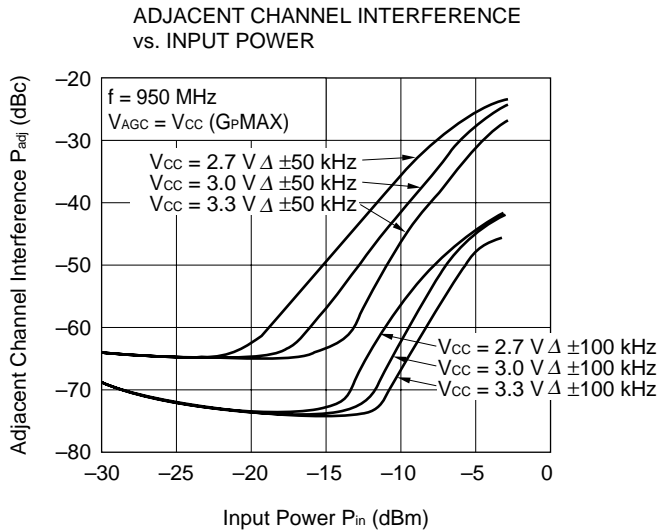
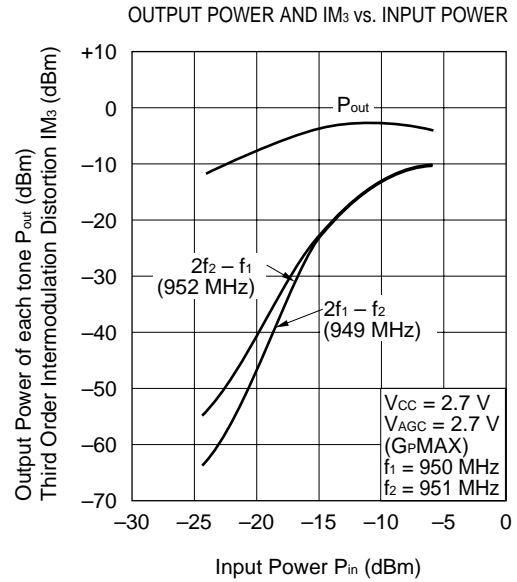
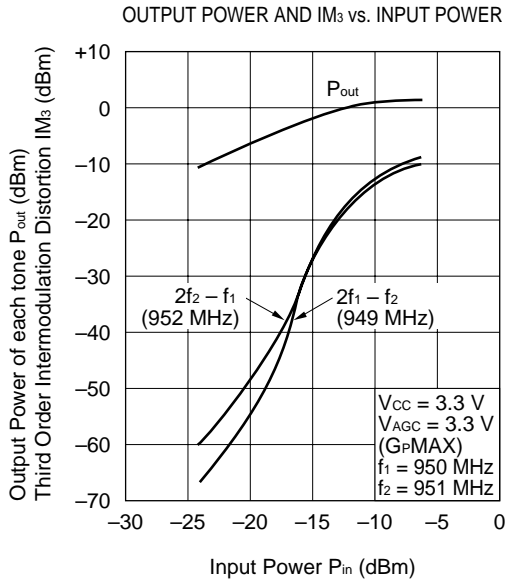

$\mu$ PC8120T

Output port matching at f = 1440 MHz

$V_{CC} = 3.0\text{ V}$ ,  $V_{AGC} = 3.0\text{ V}$  (G<sub>P</sub>MAX),  $P_{in} = -30\text{ dBm}$

S<sub>11</sub> vs. FREQUENCY 1; 36.68  $\Omega$  -50.342  $\Omega$  2.2582 pF  
1 400.000 000 MHz

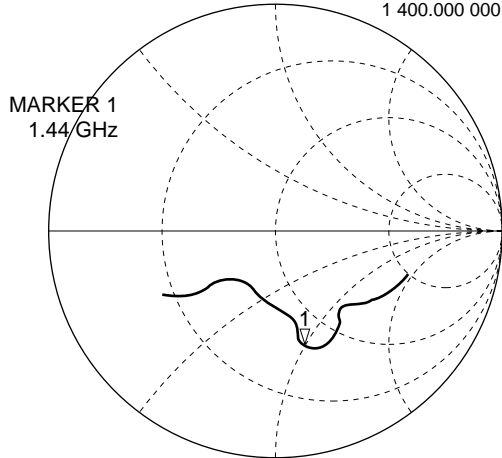

START 100.000 000 MHz STOP 3 100.000 000 MHz

S<sub>22</sub> vs. FREQUENCY 1; 48.615  $\Omega$  -5.4863  $\Omega$  -20.145 pF  
1 440.000 000 MHz

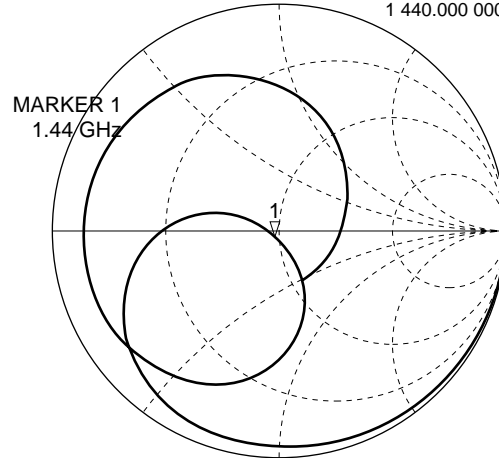

START 100.000 000 MHz STOP 3 100.000 000 MHz

S<sub>11</sub> vs. FREQUENCY  
 $V_{AGC} = 3.0\text{ V}$  (G<sub>P</sub>MAX),  $P_{in} = -30\text{ dBm}$

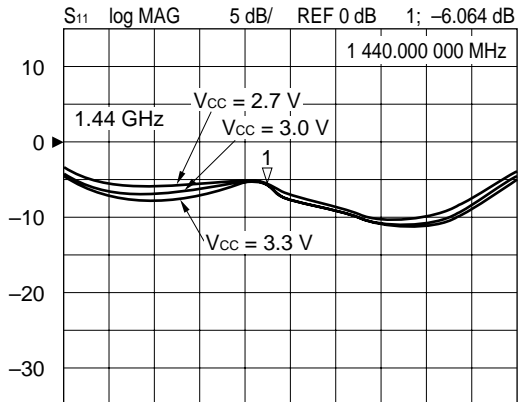

START 100.000 000 MHz STOP 3 100.000 000 MHz

S<sub>11</sub> vs. FREQUENCY  
 $V_{CC} = 3.0\text{ V}$ ,  $V_{AGC} = 3.0\text{ V}$  (G<sub>P</sub>MAX),  $P_{in} = -30\text{ dBm}$

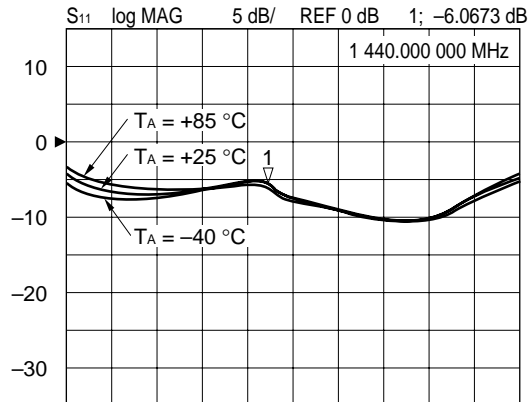

START 100.000 000 MHz STOP 3 100.000 000 MHz

S<sub>22</sub> vs. FREQUENCY  
 $V_{AGC} = 3.0\text{ V}$  (G<sub>P</sub>MAX),  $P_{in} = -30\text{ dBm}$

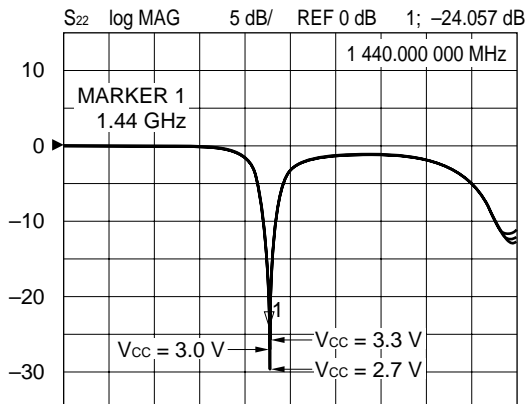

START 100.000 000 MHz STOP 3 100.000 000 MHz

S<sub>22</sub> vs. FREQUENCY  
 $V_{CC} = 3.0\text{ V}$ ,  $V_{AGC} = 3.0\text{ V}$  (G<sub>P</sub>MAX),  $P_{in} = -30\text{ dBm}$

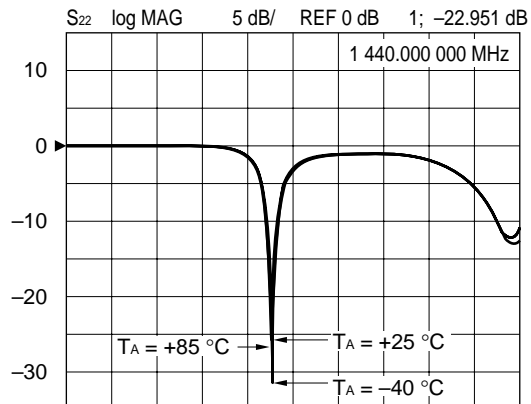

START 100.000 000 MHz STOP 3 100.000 000 MHz

—  $\mu$ PC8120T —

Output port matching at  $f = 1440$  MHz

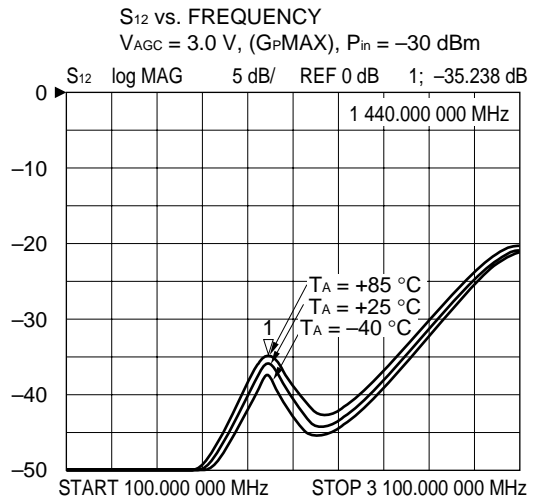
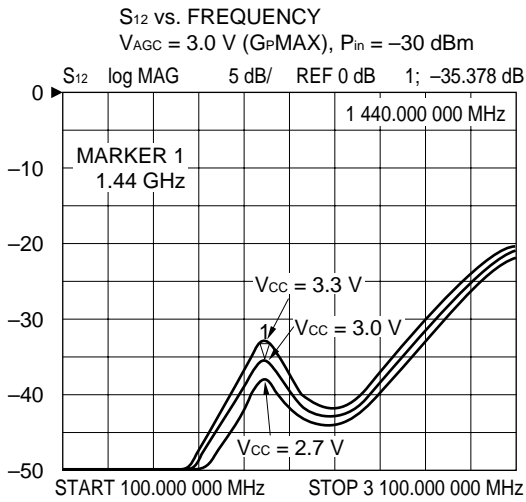
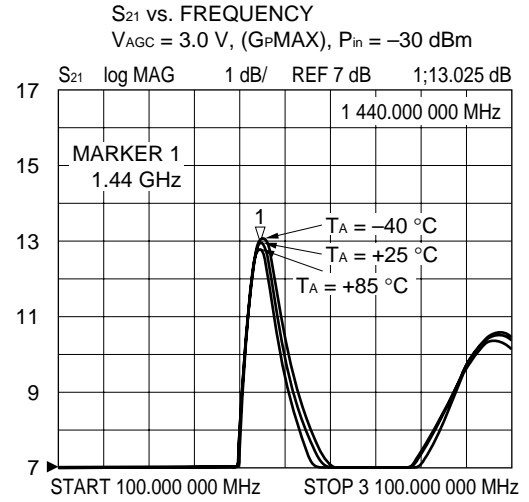
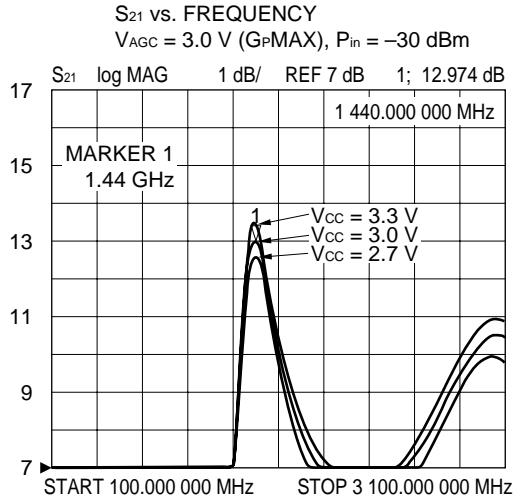

$\mu$ PC8120T

Output port matching at f = 1440 MHz

POWER GAIN vs. GAIN CONTROL VOLTAGE

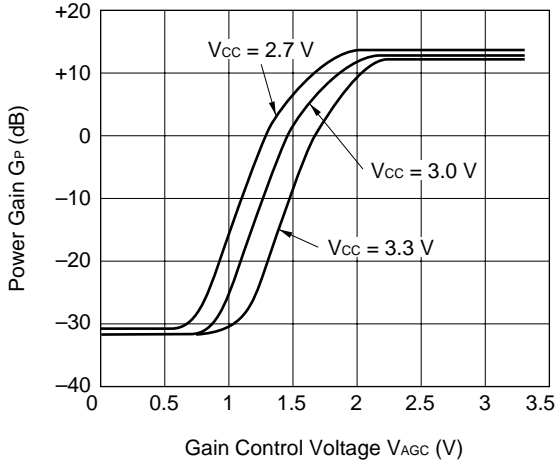

POWER GAIN vs. GAIN CONTROL VOLTAGE

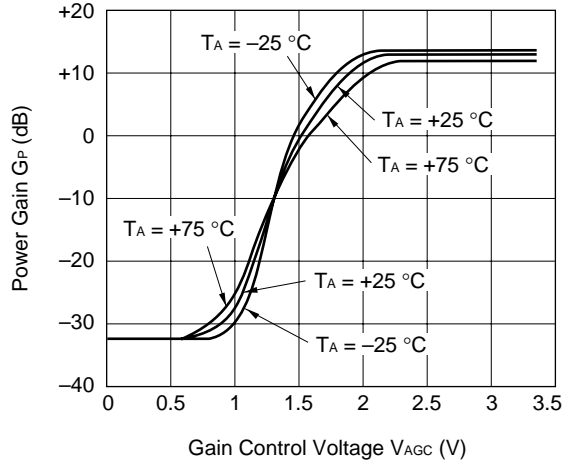

$S_{21}$  vs. FREQUENCY DEPENDENCE OF GAIN CONTROL VOLTAGE

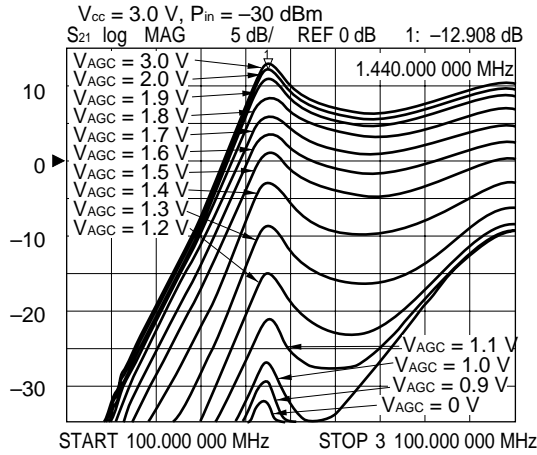

$S_{12}$  vs. FREQUENCY DEPENDENCE OF GAIN CONTROL VOLTAGE

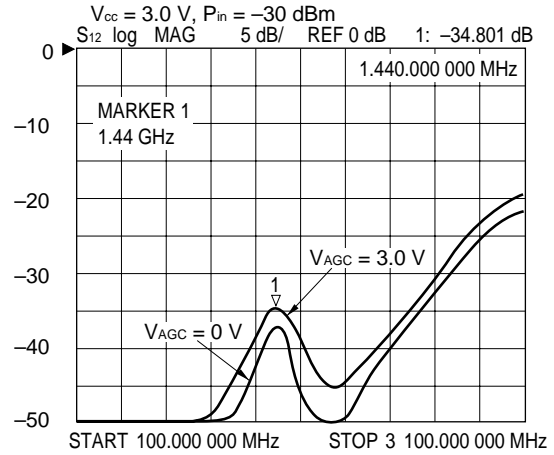

$S_{11}$  vs. FREQUENCY DEPENDENCE OF GAIN CONTROL VOLTAGE

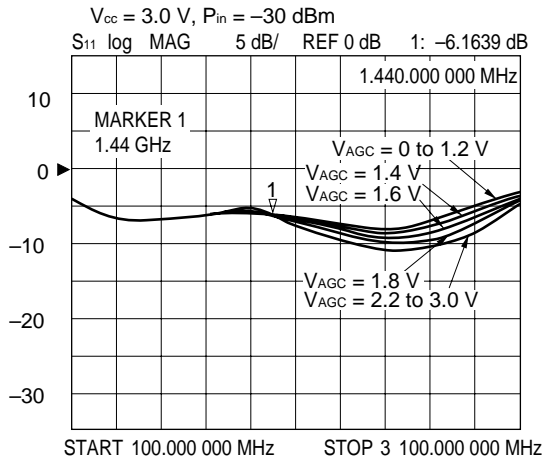

$S_{22}$  vs. FREQUENCY DEPENDENCE OF GAIN CONTROL VOLTAGE

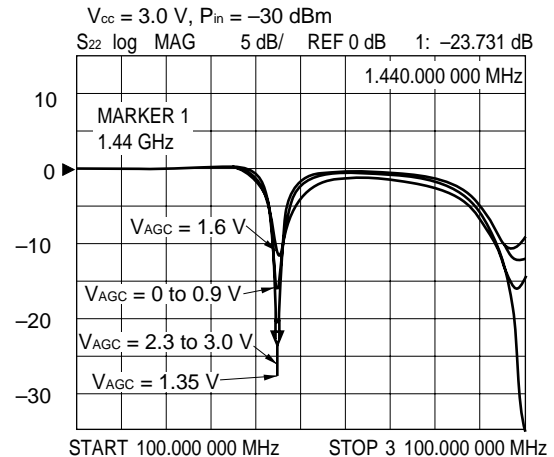

—  $\mu$ PC8120T —

Output port matching at  $f = 1440$  MHz

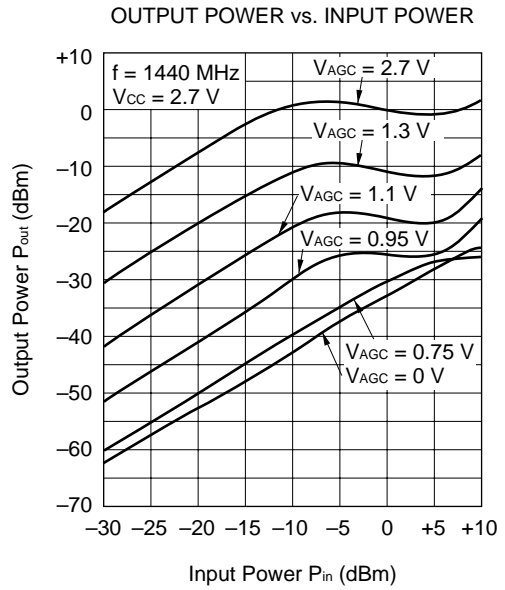
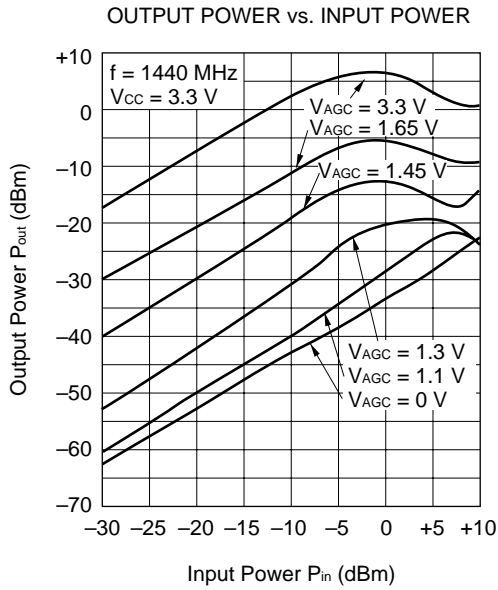
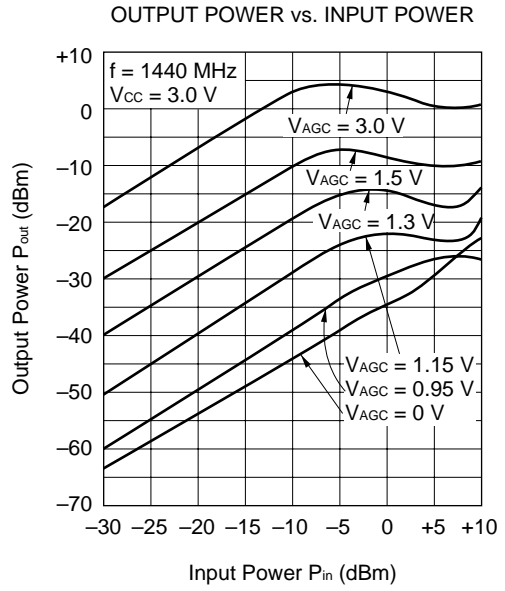
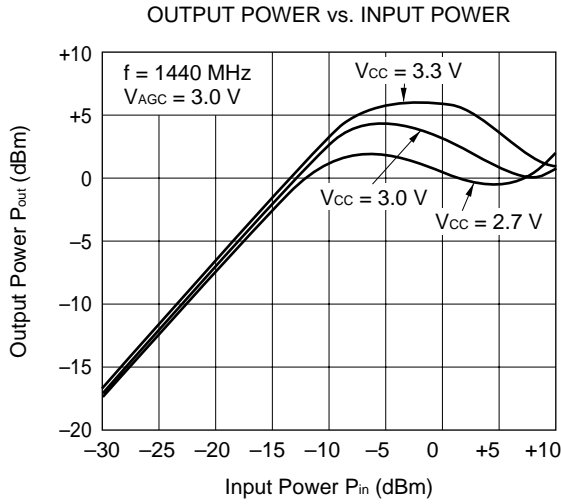

$\mu$ PC8120T

Output port matching at f = 1440 MHz

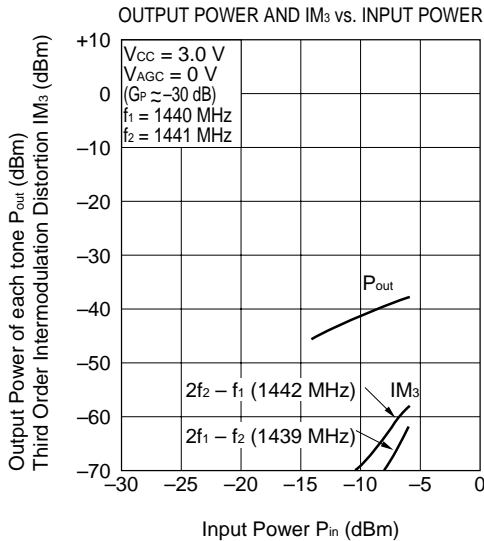
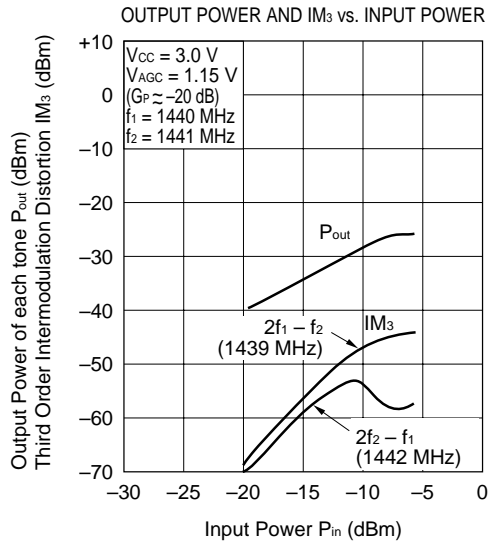
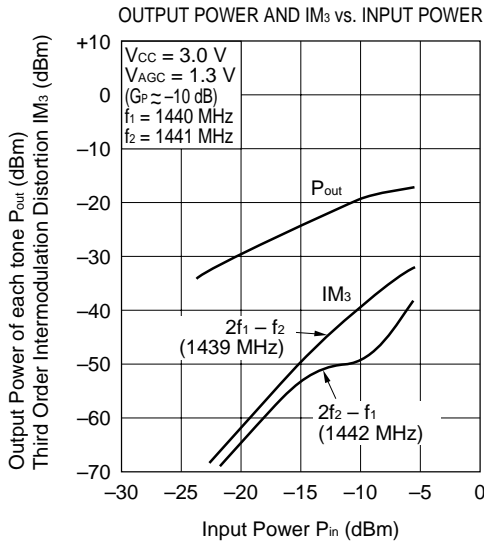
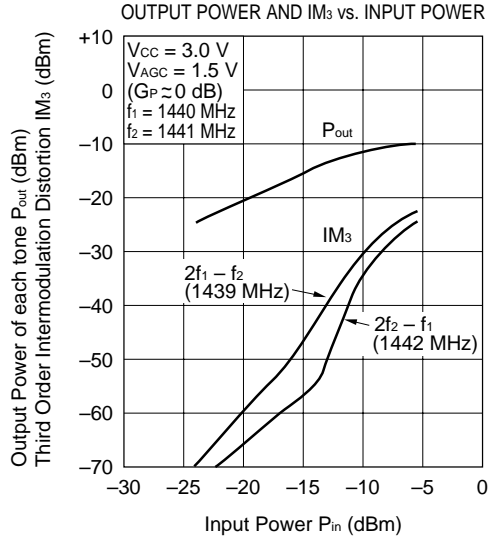
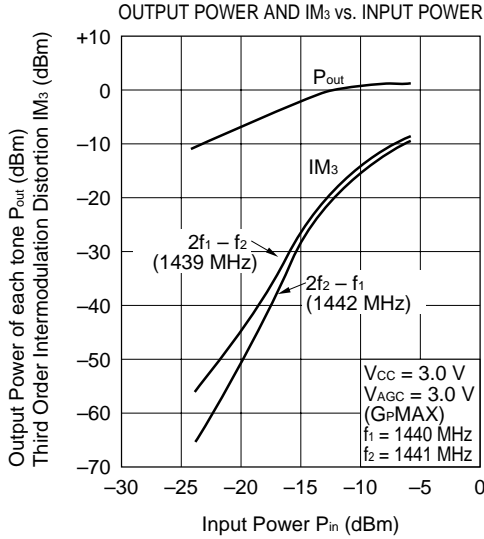



—  $\mu$ PC8120T —

Output port matching at  $f = 1440$  MHz

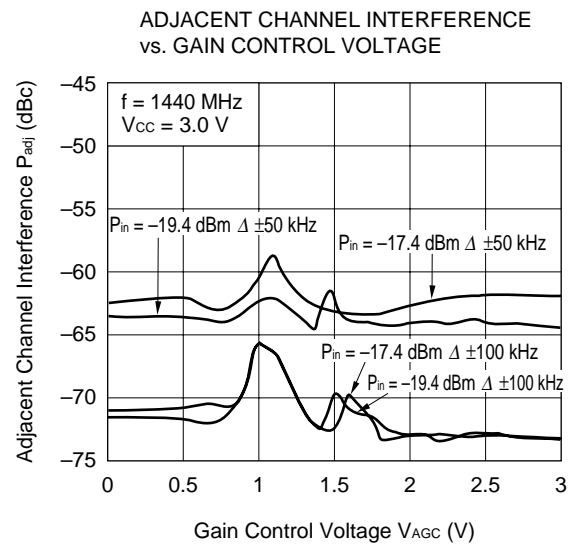
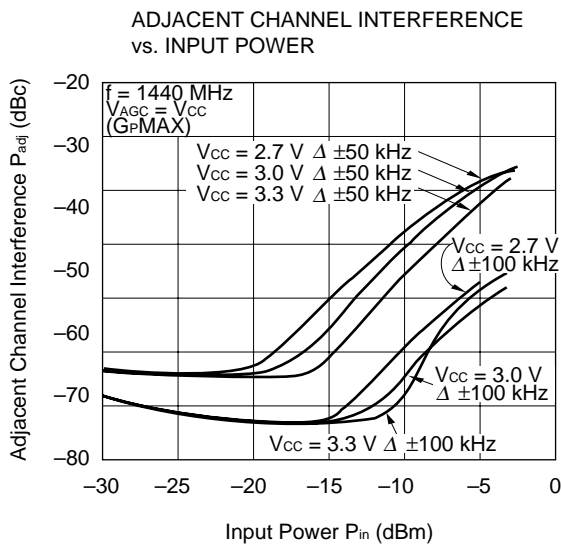
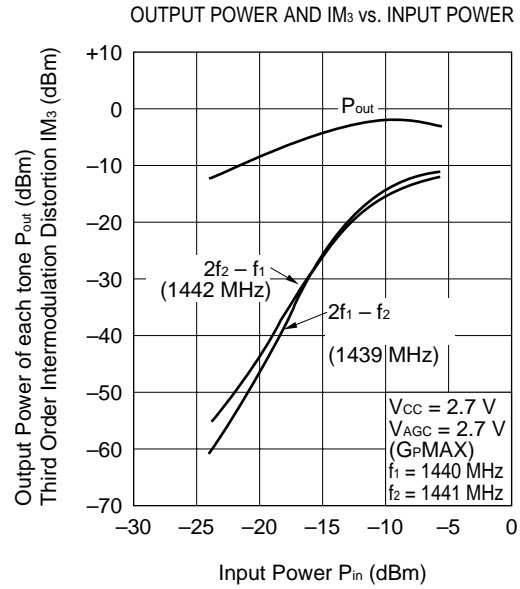
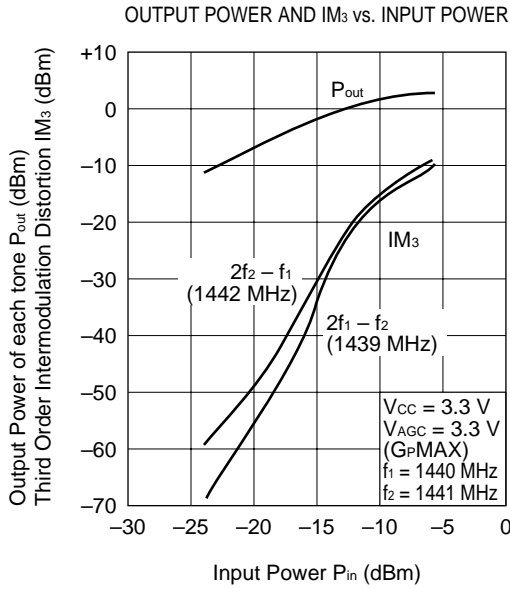

$\mu$ PC8120T

Output port matching at f = 1900 MHz

$V_{CC} = 3.0\text{ V}$ ,  $V_{AGC} = 3.0\text{ V}$  (G<sub>P</sub>MAX),  $P_{in} = -30\text{ dBm}$

S<sub>11</sub> vs. FREQUENCY 1; 24.991  $\Omega$  -27.029  $\Omega$  3.0991 pF  
1 900.000 000 MHz

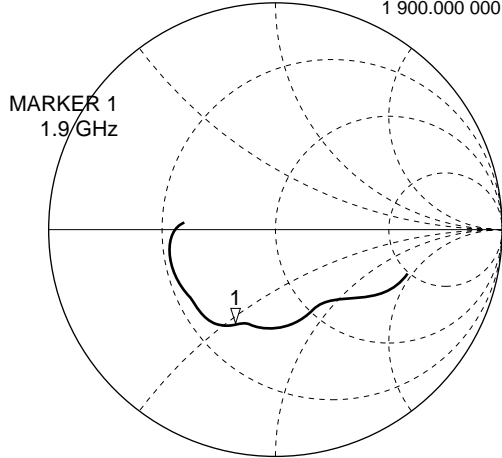

START 100.000 000 MHz STOP 100.000 000 MHz

S<sub>22</sub> vs. FREQUENCY 1; 52.643  $\Omega$  16.369  $\Omega$  1.3712 nH  
1 900.000 000 MHz

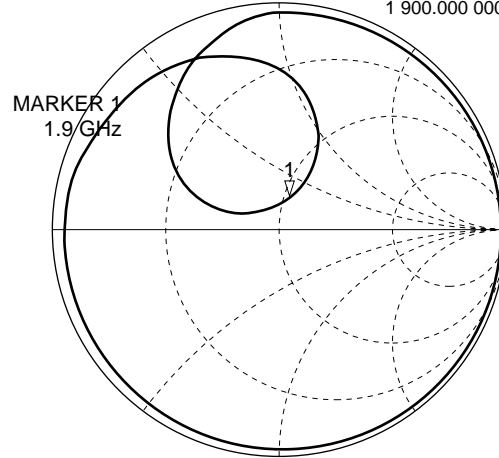

START 100.000 000 MHz STOP 100.000 000 MHz

S<sub>11</sub> vs. FREQUENCY  
 $V_{AGC} = 3.0\text{ V}$  (G<sub>P</sub>MAX),  $P_{in} = -30\text{ dBm}$

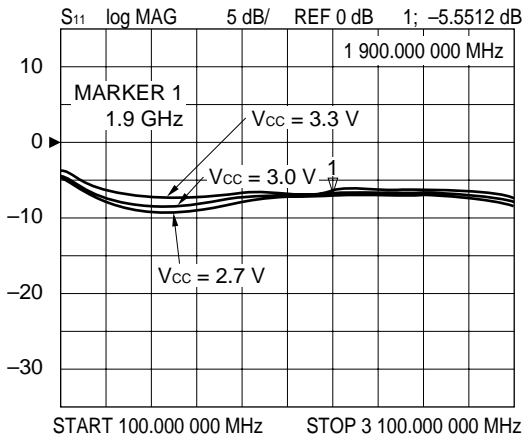

S<sub>22</sub> vs. FREQUENCY  
 $V_{AGC} = 3.0\text{ V}$  (G<sub>P</sub>MAX),  $P_{in} = -30\text{ dBm}$

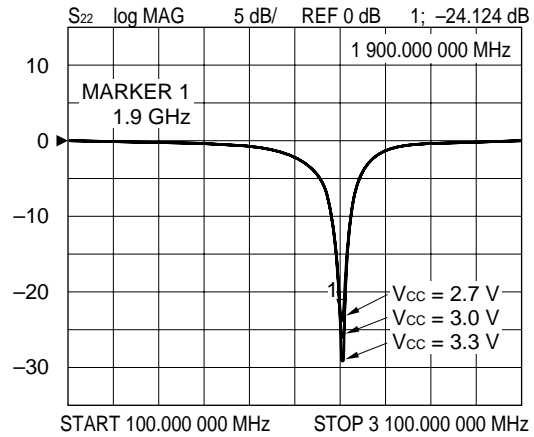

S<sub>21</sub> vs. FREQUENCY  
 $V_{AGC} = 3.0\text{ V}$  (G<sub>P</sub>MAX),  $P_{in} = -30\text{ dBm}$

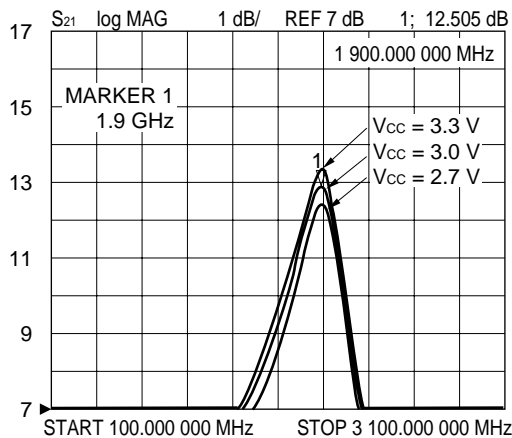

S<sub>12</sub> vs. FREQUENCY  
 $V_{AGC} = 3.0\text{ V}$  (G<sub>P</sub>MAX),  $P_{in} = -30\text{ dBm}$

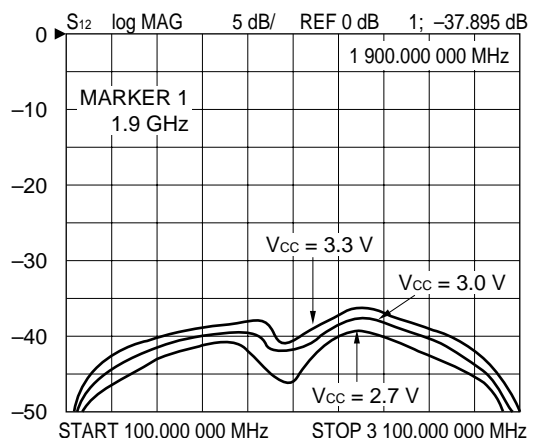

—  $\mu$ PC8120T —

Output port matching at  $f = 1900$  MHz

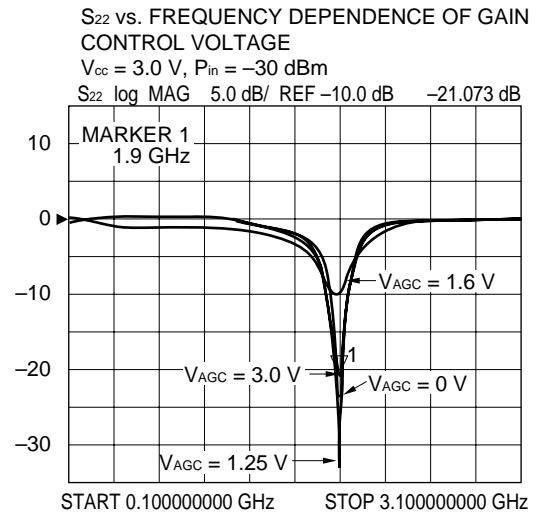
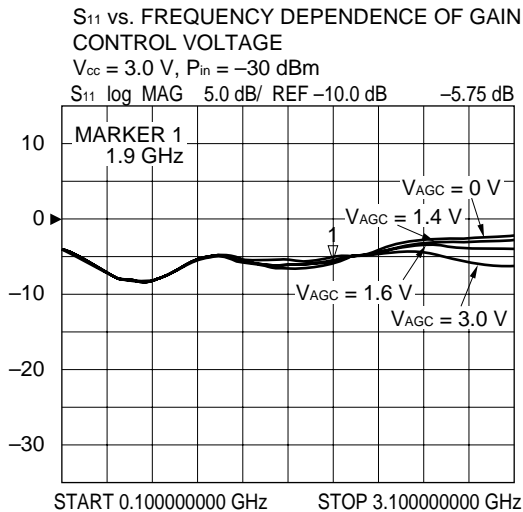
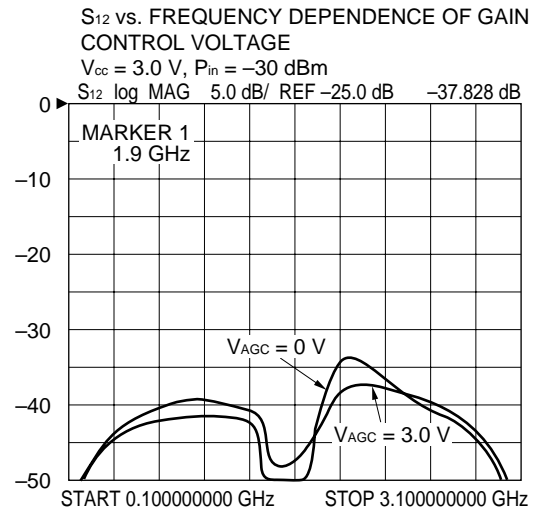
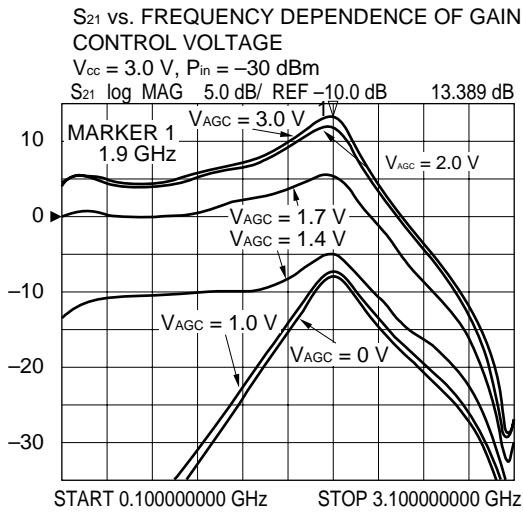
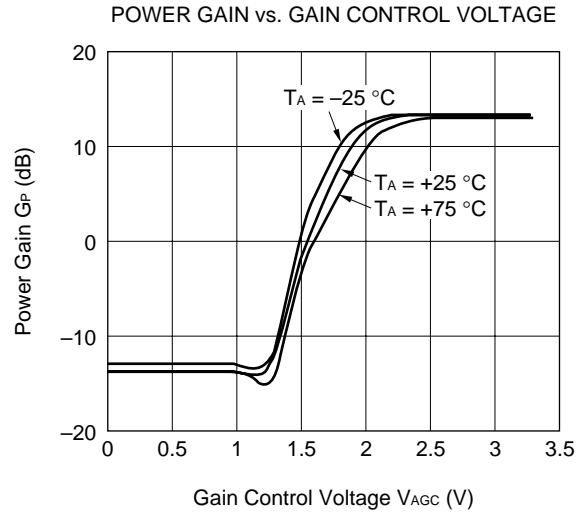
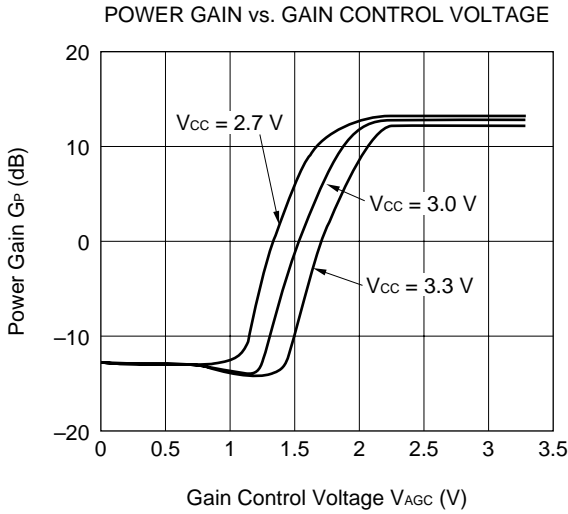

$\mu$ PC8120T

Output port matching at f = 1900 MHz

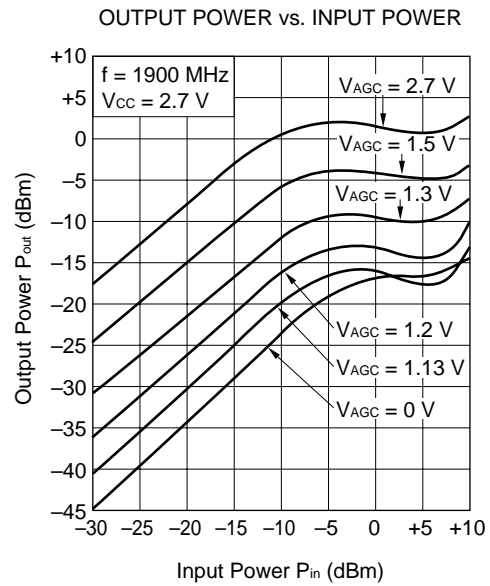
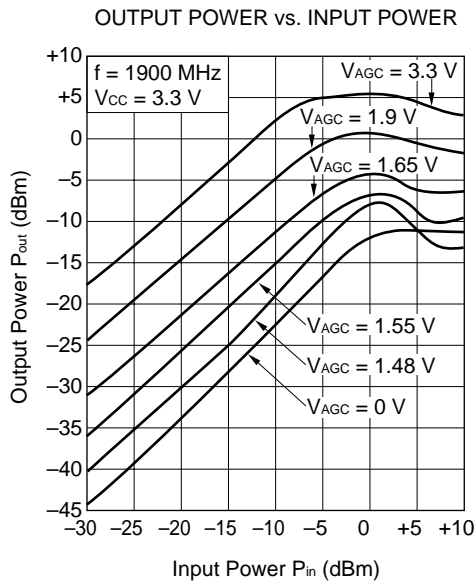
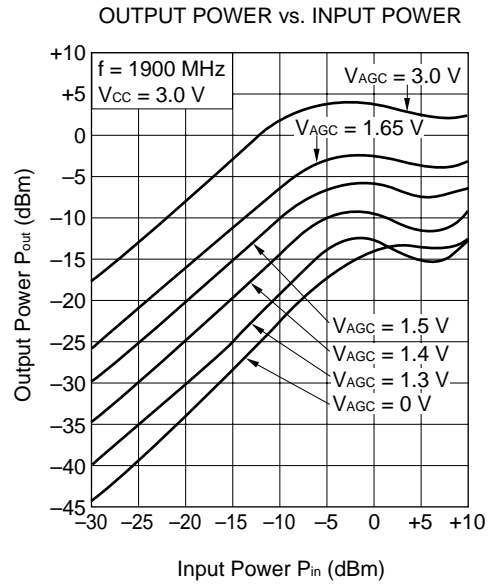
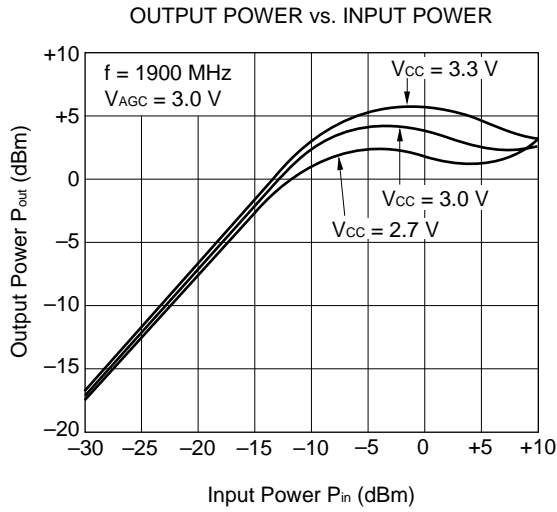

$\mu$ PC8120T

Output port matching at f = 1900 MHz

OUTPUT POWER AND IM<sub>3</sub> vs. INPUT POWER

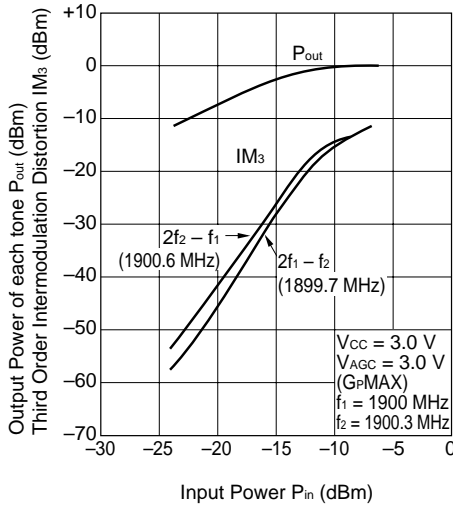

OUTPUT POWER AND IM<sub>3</sub> vs. INPUT POWER

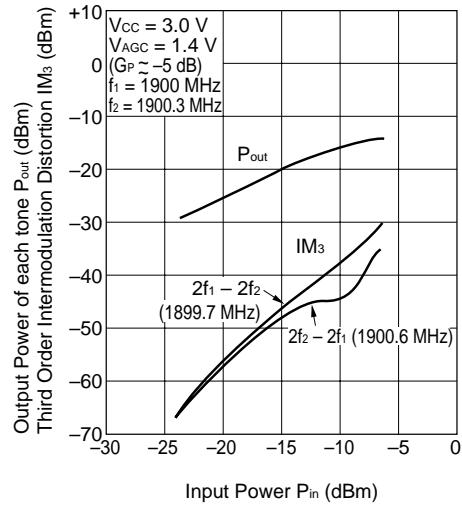

OUTPUT POWER AND IM<sub>3</sub> vs. INPUT POWER

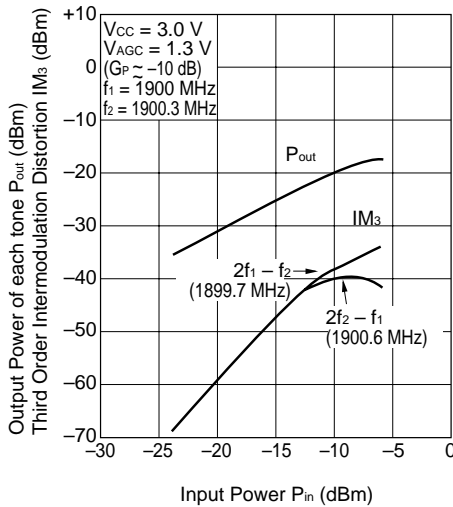

OUTPUT POWER AND IM<sub>3</sub> vs. INPUT POWER

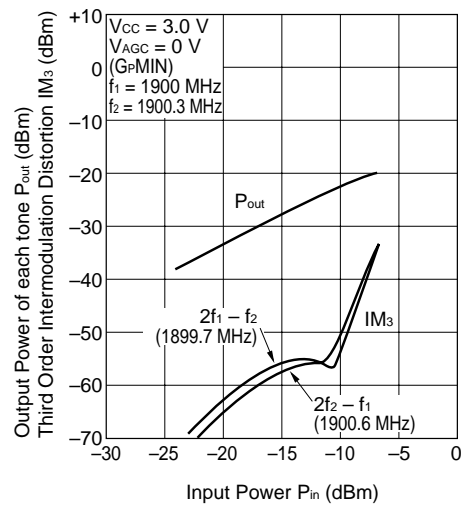

OUTPUT POWER AND IM<sub>3</sub> vs. INPUT POWER

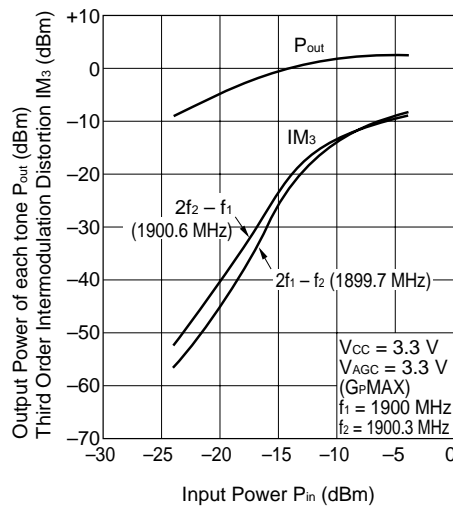

OUTPUT POWER AND IM<sub>3</sub> vs. INPUT POWER

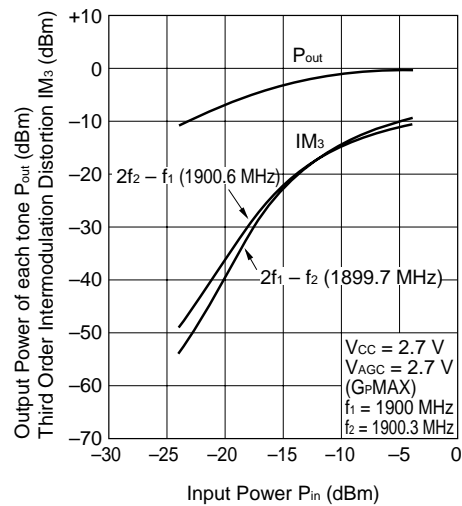

$\mu$ PC8120T

Output port matching at  $f = 1900$  MHz

ADJACENT CHANNEL INTERFERENCE vs. INPUT POWER

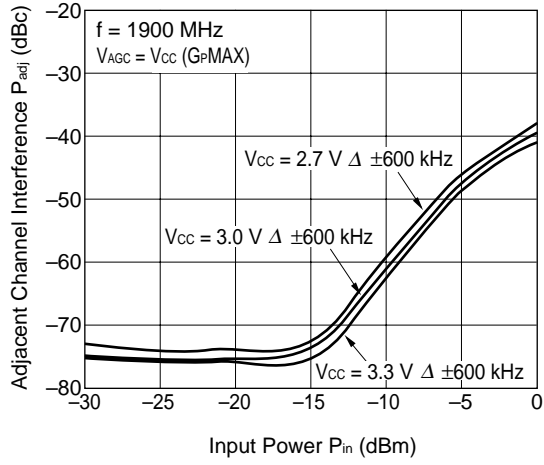

ADJACENT CHANNEL INTERFERENCE vs. GAIN CONTROL VOLTAGE

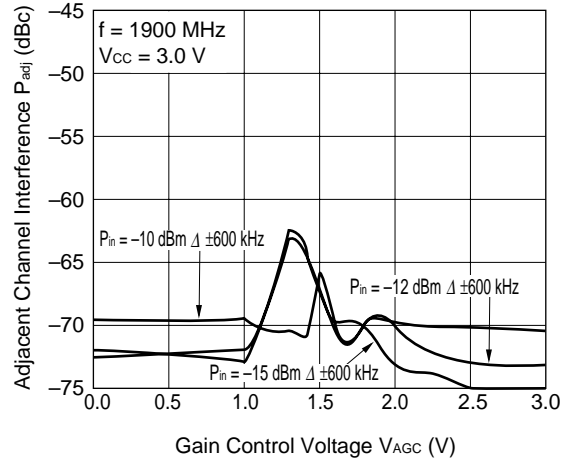

PACKAGE DIMENSIONS

6 PIN MINIMOLD PACKAGE (UNITS: mm)

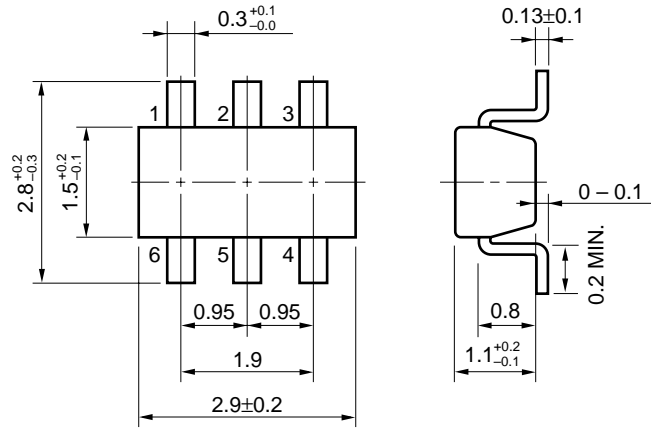

**NOTES ON CORRECT USE**

- (1) Observe precautions for handling because of electro-static sensitive devices.
- (2) Form a ground pattern as wide as possible to minimize ground impedance (to prevent undesired oscillation).
- (3) Keep the track length of the ground pins as short as possible.
- (4) A low pass filter must be attached to Vcc line.
- (5) A matching circuit must be externally attached to output port.

**RECOMMENDED SOLDERING CONDITIONS**

This product should be soldered under the following recommended conditions. For soldering methods and conditions other than those recommended below, contact your NEC sales representative.

**μPC8119T, μPC8120T**

Soldering Method	Soldering Conditions	Recommended Condition Symbol
Infrared Reflow	Package peak temperature: 235°C or below Time: 30 seconds or less (at 210°C) Count: 3, Exposure limit <sup>Note</sup> : None	IR35-00-3
VPS	Package peak temperature: 215°C or below Time: 40 seconds or less (at 200°C) Count: 3, Exposure limit <sup>Note</sup> : None	VP15-00-3
Wave Soldering	Soldering bath temperature: 260°C or below Time: 10 seconds or less Count: 1, Exposure limit <sup>Note</sup> : None	WS60-00-1
Partial Heating	Pin temperature: 300°C Time: 3 seconds or less (per side of device) Exposure limit <sup>Note</sup> : None	—

**Note** After opening the dry pack, keep it in a place below 25°C and 65% RH for the allowable storage period.

**Caution** Do not use different soldering methods together (except for partial heating).

For details of the recommended soldering conditions for surface mounting, refer to information document SEMICONDUCTOR DEVICE MOUNTING TECHNOLOGY MANUAL (C10535E).



[MEMO]

[MEMO]

[MEMO]

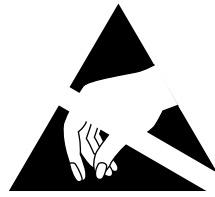
**ATTENTION**

OBSERVE PRECAUTIONS  
FOR HANDLING  
ELECTROSTATIC  
SENSITIVE  
DEVICES

The application circuits and their parameters are for reference only and are not intended for use in actual design-ins.

**NESAT (NEC Silicon Advanced Technology) is a trademark of NEC Corporation.**

No part of this document may be copied or reproduced in any form or by any means without the prior written consent of NEC Corporation. NEC Corporation assumes no responsibility for any errors which may appear in this document.

NEC Corporation does not assume any liability for infringement of patents, copyrights or other intellectual property rights of third parties by or arising from use of a device described herein or any other liability arising from use of such device. No license, either express, implied or otherwise, is granted under any patents, copyrights or other intellectual property rights of NEC Corporation or others.

While NEC Corporation has been making continuous effort to enhance the reliability of its semiconductor devices, the possibility of defects cannot be eliminated entirely. To minimize risks of damage or injury to persons or property arising from a defect in an NEC semiconductor device, customers must incorporate sufficient safety measures in its design, such as redundancy, fire-containment, and anti-failure features.

NEC devices are classified into the following three quality grades:

"Standard", "Special", and "Specific". The Specific quality grade applies only to devices developed based on a customer designated "quality assurance program" for a specific application. The recommended applications of a device depend on its quality grade, as indicated below. Customers must check the quality grade of each device before using it in a particular application.

**Standard:** Computers, office equipment, communications equipment, test and measurement equipment, audio and visual equipment, home electronic appliances, machine tools, personal electronic equipment and industrial robots

**Special:** Transportation equipment (automobiles, trains, ships, etc.), traffic control systems, anti-disaster systems, anti-crime systems, safety equipment and medical equipment (not specifically designed for life support)

**Specific:** Aircrafts, aerospace equipment, submersible repeaters, nuclear reactor control systems, life support systems or medical equipment for life support, etc.

The quality grade of NEC devices is "Standard" unless otherwise specified in NEC's Data Sheets or Data Books. If customers intend to use NEC devices for applications other than those specified for Standard quality grade, they should contact an NEC sales representative in advance.

Anti-radioactive design is not implemented in this product.