

L-BAND SPDT SWITCH

DESCRIPTION

The μ PG152TA is an L-band SPDT (Single Pole Double Throw) GaAs FET switch which was developed for digital cellular or cordless telephone application. The device can operate from 100 MHz to 2.5 GHz, having the low insertion loss.

It housed in as original 6 pin mini-mold that is smaller than usual 8 pin SSOP and easy to install and contributes to miniaturizing the system. It can be used in wide-band switching applications.

FEATURES

- Low insertion loss : $L_{INS} = 0.6$ dB typ. @ $f = 2$ GHz
- High power switching : $P_{in(1\text{ dB})} = +30$ dBm typ. @ $V_{CONT} = +3.0$ V/0 V, $f = 2$ GHz
- Small 6 pin mini-mold

APPLICATION

- Digital cordless telephone : PHS, DECT, PCS etc.
- Digital hand-held cellular phone: PDC Antenna diversity etc.

ORDERING INFORMATION

PART NUMBER	PACKAGE	PACKING FORM
μ PG152TA-E3	6 pins Mini-mold	Carrier tape width 8 mm, 1 pin faces toward the open end of the tape, 3000 pcs/Reel

Remark For evaluation sample order, please contact your local NEC sales office.
(Part number for sample order: μ PG152TA)

ABSOLUTE MAXIMUM RATINGS ($T_A = 25$ °C)

PARAMETERS	SYMBOL	RATING	UNIT
Control Voltage 1, 2	$V_{CONT1, 2}$	-6.0 to +6.0 ^{Note}	V
Input Power	P_{in}	+31	dBm
Total Power Dissipation	P_{tot}	0.4	W
Operating Temperature	T_A	-50 to +80	°C
Storage Temperature	T_{stg}	-65 to +150	°C

Note Condition $2.7 \leq |V_{CONT1} - V_{CONT2}| \leq 6.0$ V

Caution The IC must be handled with care to prevent static discharge because its circuit is composed of GaAs MES FET.

PIN CONNECTION DIAGRAM

PIN No.	CONNECTION	PIN No.	CONNECTION
1	OUT1	4	V _{CONT 2}
2	GND	5	IN
3	OUT2	6	V _{CONT 1}

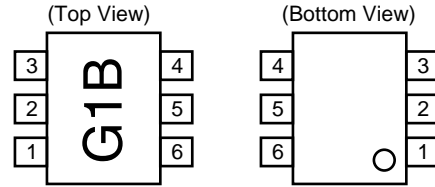

RECOMMENDED OPERATING CONDITIONS (T_A = 25 °C)

PARAMETERS	SYMBOL	MIN.	TYP.	MAX.	UNIT
Control Voltage (OFF)	V _{CONT}	+2.7	+3.0	+5.3	V
Control Voltage (ON)	V _{CONT}	-0.2	0	+0.2	V
Input Power (V _{CONT} = 3 V/0 V)	P _{in}		+27	+29	dBm

ELECTRICAL CHARACTERISTICS (Unless otherwise specified, T_A = 25 °C, V_{CONT1} = 3 V, V_{CONT2} = 0 V or V_{CONT1} = 0 V, V_{CONT2} = 3 V, Off chip DC blocking capacitors value; 51 pF)

CHARACTERISTICS	SYMBOL	TEST CONDITIONS	MIN.	TYP.	MAX.	UNIT
Insertion Loss	L _{INS}	f = 100 M to 2 GHz		0.6	1.0	dB
		f = 2.5 GHz		0.8 ^{Note 1}		
Isolation	ISL	f = 100 M to 2 GHz	20	22		dB
		f = 2.5 GHz	20 ^{Note 1}			
Input Return Loss	R _{Iin}	f = 100 M to 2 GHz	11			dB
Output Return Loss	R _{Iout}	f = 100 M to 2 GHz	11			dB
Input Power at 1 dB Compression Point ^{Note 2}	P _{in(1 dB)}	f = 1 GHz to 2 GHz	27	30		dBm
Switching Speed	t _{sw}			30		ns
Control Current	I _{CONT}	V _{CONT} = 3 V/0 V RF None			5	μA

- Notes**
- 1 Characteristic for reference at 2.0 to 2.5 GHz
 - 2 Pin(1 dB) is measured the input power level when the insertion loss increase more 1 dB than that of linear range. All other characteristics are measured in linear range.
 - 3 When the μPG152TA is used it is necessary to use DC blocking capacitors for No.1 (OUT1), No.3 (OUT2) and No.5 (IN). The value of DC blocking capacitors should be chosen to accommodate the frequency of operation, band width, switching speed and the condition with actual board of your system. The range of recommended DC blocking capacitor value is less than 100 pF.
 - 4 The distance between IC's GND pin and ground pattern of substrate should be as shorter as possible to avoid parasitic parameters.

TYPICAL CHARACTERISTICS (T_A = 25 °C)

Note This data is including loss of the test fixture

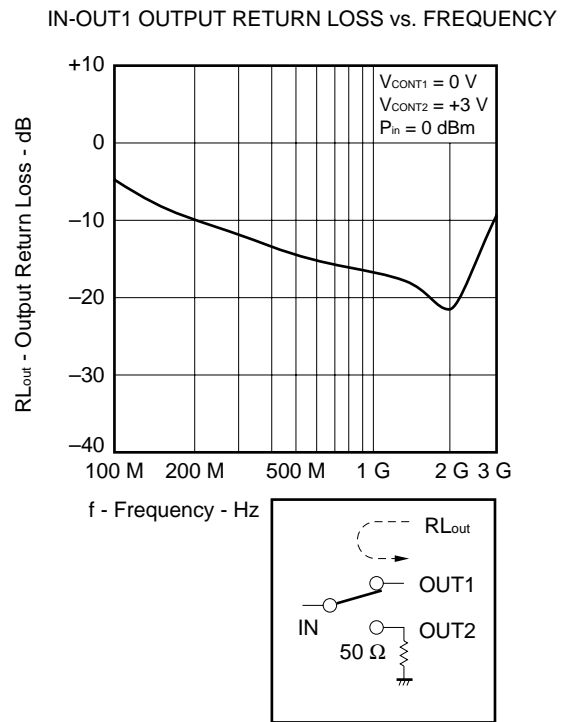
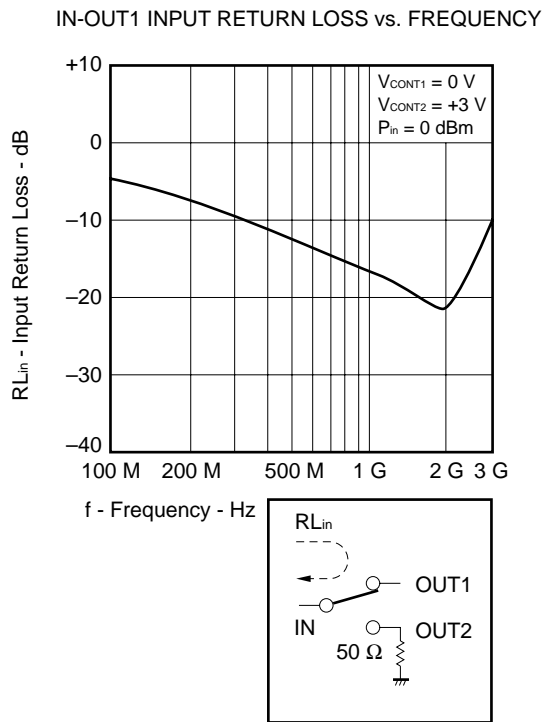
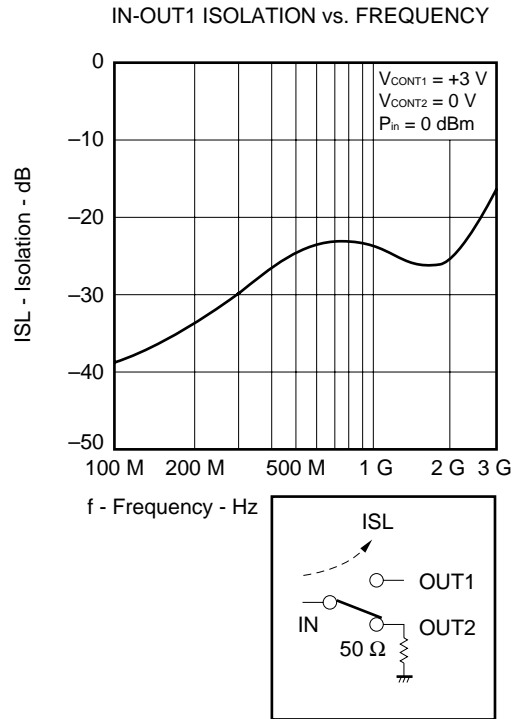
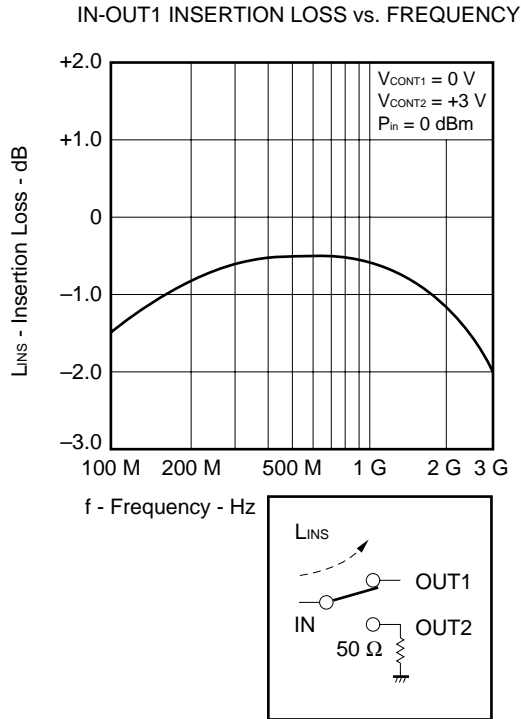

IN-OUT2 INSERTION LOSS vs. FREQUENCY

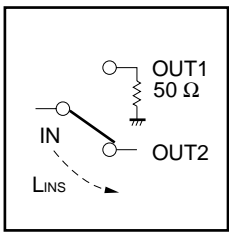
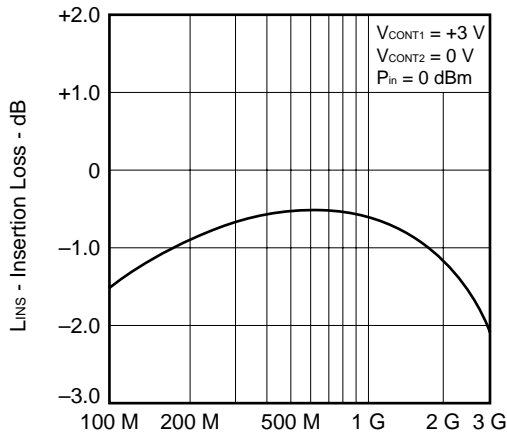

IN-OUT2 ISOLATION vs. FREQUENCY

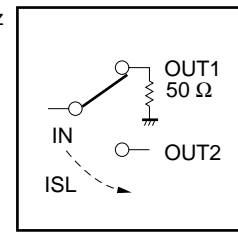
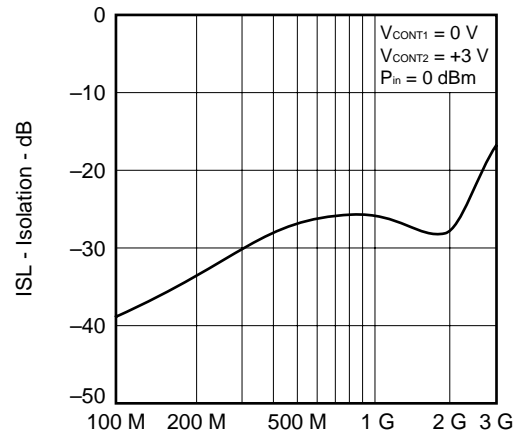

IN-OUT2 INPUT RETURN LOSS vs. FREQUENCY

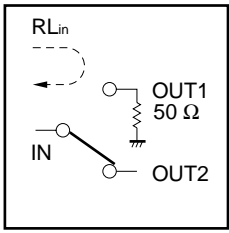
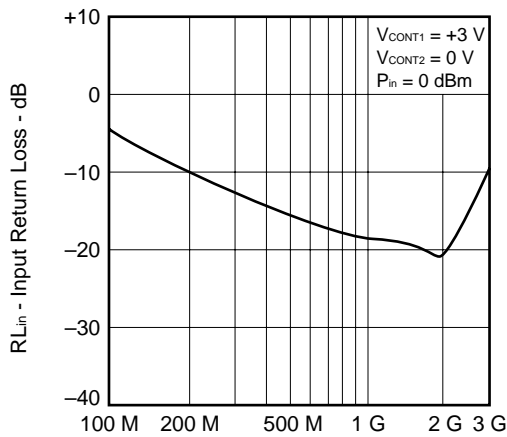

IN-OUT2 OUTPUT RETURN LOSS vs. FREQUENCY

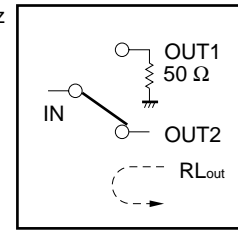
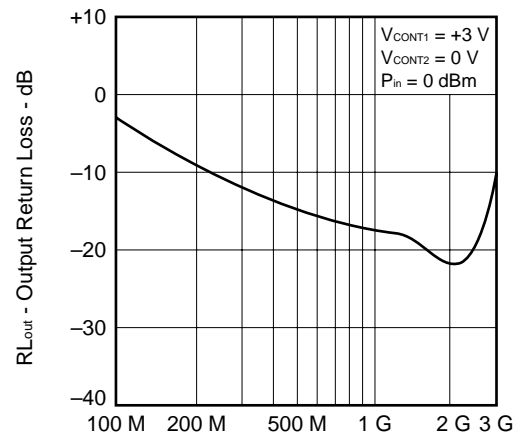

Temperature characteristics

Temperature Characteristics of Input/Output

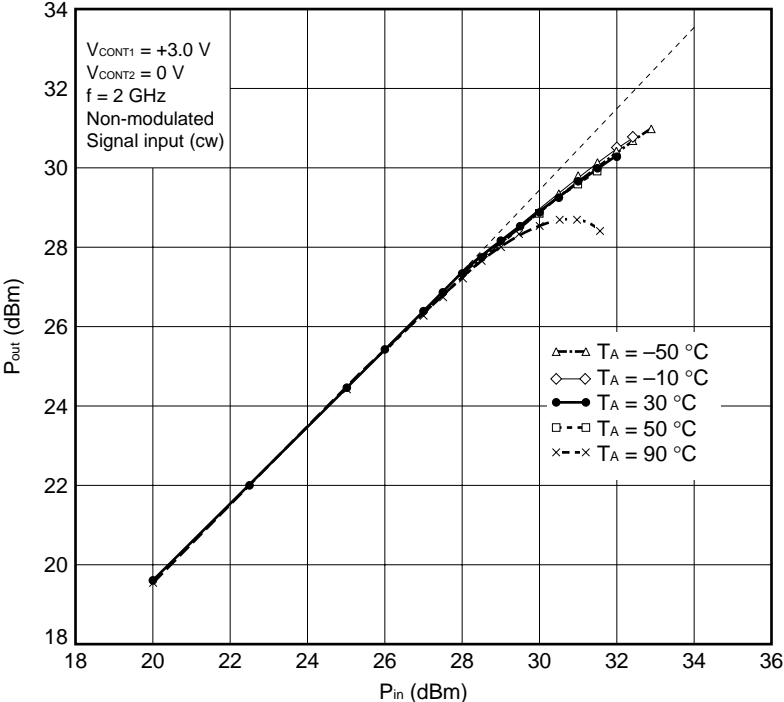

TEST CIRCUIT

$T_A = 25\text{ }^\circ\text{C}$, $V_{\text{CONT1}} = +3\text{ V}$, $V_{\text{CONT2}} = 0\text{ V}$ or $V_{\text{CONT1}} = 0\text{ V}$, $V_{\text{CONT2}} = +3\text{ V}$, $f = 2\text{ GHz}$

Off chip DC blocking capacitors value; 51 pF, Using NEC standard evaluation board

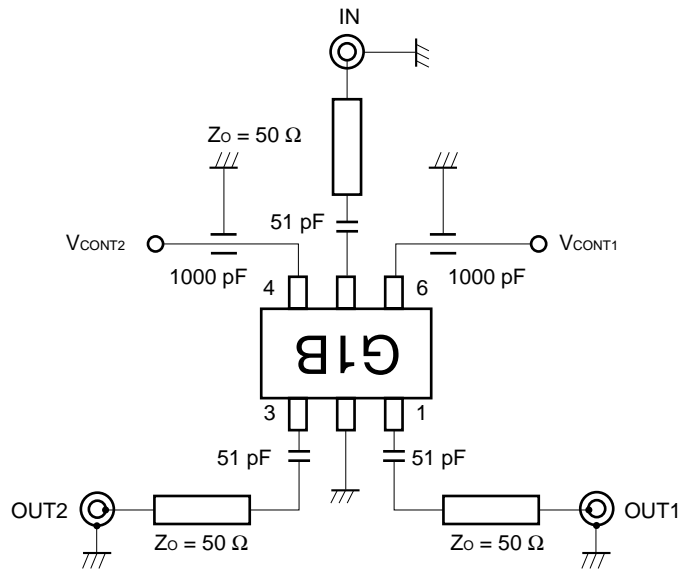

6 PIN MINI-MOLD PACKAGE DIMENSIONS (UNIT: mm)

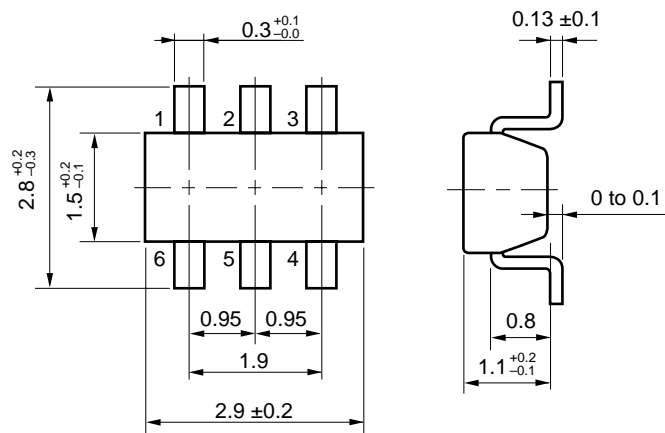

TRUTH TABLE OF SWITCHING BY CONDITION OF CONTROL VOLTAGE

		V _{CONT1}	
		+3 V	0 V
V _{CONT2}	+3 V		
	0 V		

EVALUATION BOARD

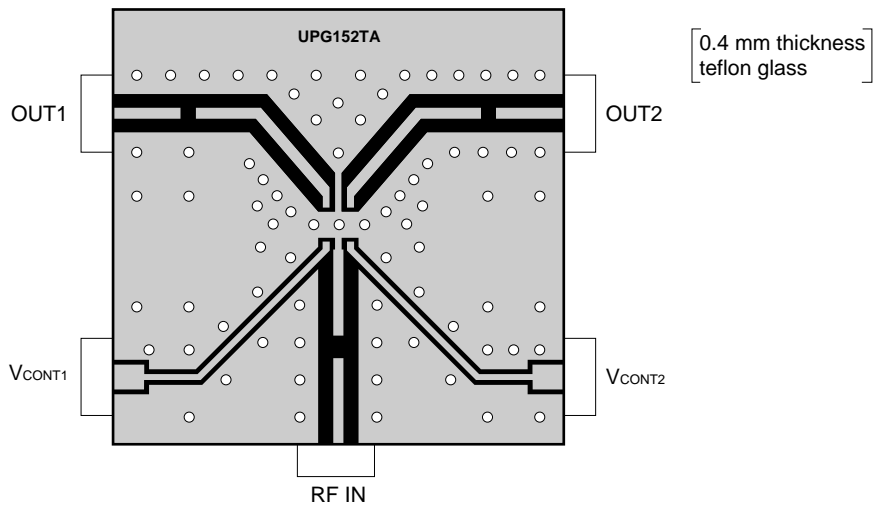

RECOMMENDED SOLDERING CONDITIONS

This Product should be soldered in the following recommended conditions. Other soldering methods and conditions than the recommended conditions are to be consulted with our sales representatives.

Soldering process	Soldering conditions	Recommended condition symbol
Infrared ray reflow	Package peak temperature: 235 °C Hour: within 30 s. (more than 210 °C) Time: 3 times, Limited days: no. ^{Note}	IR35-00-3
VPS	Package peak temperature: 215 °C Hour: within 40 s. (more than 200 °C) Time: 3 times, Limited days: no. ^{Note}	VP15-00-3
Wave Soldering	Soldering tub temperature: less than 260 °C, Hour: within 10 s. Time: 1 time, Limited days: no. ^{Note}	WS60-00-1
Pin part heating	Pin area temperature: less than 300 °C, Hour: within 3 s. Limited days: no. ^{Note}	

Note It is the storage days after opening a dry pack, the storage conditions are 25 °C, less than 65 %, RH.

Caution The combined use of soldering method is to be avoided (However, except the pin area heating method).

For details of recommended soldering conditions for surface mounting, refer to information document **SEMICONDUCTOR DEVICE MOUNTING TECHNOLOGY MANUAL (C10535E)**.

[MEMO]

[MEMO]

[MEMO]

Caution

**The Great Care must be taken in dealing with the devices in this guide.
The reason is that the material of the devices is GaAs (Gallium Arsenide), which is
designated as harmful substance according to the law concerned.
Keep the law concerned and so on, especially in case of removal.**

The application circuits and their parameters are for reference only and are not intended for use in actual design-ins.

No part of this document may be copied or reproduced in any form or by any means without the prior written consent of NEC Corporation. NEC Corporation assumes no responsibility for any errors which may appear in this document.

NEC Corporation does not assume any liability for infringement of patents, copyrights or other intellectual property rights of third parties by or arising from use of a device described herein or any other liability arising from use of such device. No license, either express, implied or otherwise, is granted under any patents, copyrights or other intellectual property rights of NEC Corporation or others.

While NEC Corporation has been making continuous effort to enhance the reliability of its semiconductor devices, the possibility of defects cannot be eliminated entirely. To minimize risks of damage or injury to persons or property arising from a defect in an NEC semiconductor device, customers must incorporate sufficient safety measures in its design, such as redundancy, fire-containment, and anti-failure features.

NEC devices are classified into the following three quality grades:

"Standard", "Special", and "Specific". The Specific quality grade applies only to devices developed based on a customer designated "quality assurance program" for a specific application. The recommended applications of a device depend on its quality grade, as indicated below. Customers must check the quality grade of each device before using it in a particular application.

Standard: Computers, office equipment, communications equipment, test and measurement equipment, audio and visual equipment, home electronic appliances, machine tools, personal electronic equipment and industrial robots

Special: Transportation equipment (automobiles, trains, ships, etc.), traffic control systems, anti-disaster systems, anti-crime systems, safety equipment and medical equipment (not specifically designed for life support)

Specific: Aircrafts, aerospace equipment, submersible repeaters, nuclear reactor control systems, life support systems or medical equipment for life support, etc.

The quality grade of NEC devices is "Standard" unless otherwise specified in NEC's Data Sheets or Data Books. If customers intend to use NEC devices for applications other than those specified for Standard quality grade, they should contact an NEC sales representative in advance.

Anti-radioactive design is not implemented in this product.