

TOSHIBA CMOS Linear Integrated Circuit Silicon Monolithic

# TCR5SB15~TCR5SB50

## 200mA CMOS Low-Dropout Regulator (Point Regulator)

TCR5SB15~TCR5SB50 are single output voltage regulators for general purpose in CMOS process, and these provide low dropout, low bias current, and control function. TCR5SB15~TCR5SB50 perform ON/OFF operation for IC by control pin.

Output voltage is fixed from 1.5V to 5.0V by per 0.1V step. Maximum output current is 200mA, and overcurrent protection circuit is designed in.

Package sizes are available in SMV (SOT23-5) (SC-74A), and compact ceramic capacitors can be used at input and output. These devices are suitable for use of portable equipment such as cellular phone.

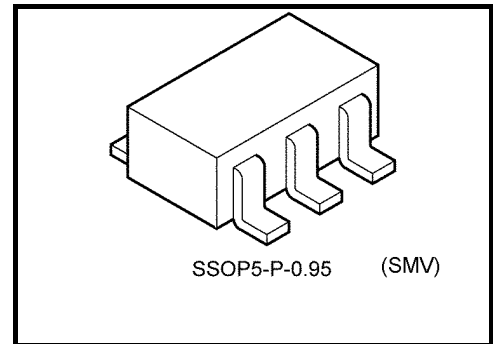

Weight: 0.014 g (typ.)

### Features

- Low quiescent current (  $I_B = 40 \mu\text{A}$  (typ.) at  $I_{OUT} = 0 \text{ mA}$  )
- Low stand-by current (  $I_{B(OFF)} = 0.1 \mu\text{A}$  (typ.) @ Stand-by mode )
- Low-dropout voltage (  $V_{IN} - V_{OUT} = 85 \text{ mV}$  (typ.) at TCR5SB30,  $I_{OUT} = 50 \text{ mA}$  )
- High current output (  $I_{OUT} = 200 \text{ mA}$  (max) )
- High ripple rejection ( R.R = 80 dB (typ) @  $I_{OUT} = 10 \text{ mA}$ ,  $f = 1\text{kHz}$  )
- Low output noise voltage (  $V_{NO} = 30 \mu\text{V}_{rms}$  (typ.) @ TCR5SB30,  $I_{OUT} = 10 \text{ mA}$ ,  $10 \text{ Hz} \leq f \leq 100 \text{ kHz}$  )
- Control voltage can be allowed from -0.3 to 6 V regardless of  $V_{IN}$  voltage.
- Overcurrent protection
- Ceramic capacitors can be used (  $C_{IN} = 0.1\mu\text{F}$ ,  $C_{OUT} = 1.0 \mu\text{F}$  )
- Wide range voltage listing (Please see Output Voltage Accuracy at page 4 for variety of the output voltage )
- Small package, SMV (SOT23-5) (SC-74A)
- RoHS compatible

### Pin Assignment (top view)

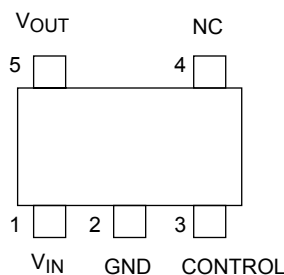

## List of Products Number and Marking

Products No.	Marking	Products No.	Marking
TCR5SB15	1E5	TCR5SB33	3E3
TCR5SB16	1E6	TCR5SB34	3E4
TCR5SB17	1E7	TCR5SB35	3E5
TCR5SB18	1E8	TCR5SB36	3E6
TCR5SB19	1B9	TCR5SB37	3E7
TCR5SB20	2E0	TCR5SB38	3E8
TCR5SB21	2E1	TCR5SB39	3E9
TCR5SB22	2E2	TCR5SB40	4E0
TCR5SB23	2E3	TCR5SB41	4E1
TCR5SB24	2E4	TCR5SB42	4E2
TCR5SB25	2E5	TCR5SB43	4E3
TCR5SB26	2E6	TCR5SB44	4E4
TCR5SB27	2E7	TCR5SB45	4E5
TCR5SB28	2E8	TCR5SB46	4E6
TCR5SB29	2E9	TCR5SB47	4E7
TCR5SB30	3E0	TCR5SB48	4E8
TCR5SB31	3E1	TCR5SB49	4E9
TCR5SB32	3E2	TCR5SB50	5E0

## Marking

Example: TCR5SB30 (3.0 V output)

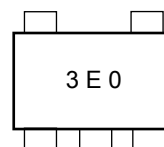

## Absolute Maximum Ratings (Ta = 25°C)

Characteristics	Symbol	Rating	Unit
Input voltage	$V_{IN}$	6	V
Control voltage	$V_{CT}$	-0.3~ 6	V
Output voltage	$V_{OUT}$	-0.3~ $V_{IN} + 0.3$	V
Output current	$I_{OUT}$	200	mA
Power dissipation	$P_D$	200 (Note 1)	mW
		380 (Note 2)	
Operation temperature range	$T_{opr}$	-40~85	°C
Junction temperature	$T_j$	150	°C
Storage temperature range	$T_{stg}$	-55~150	°C

Note: Using continuously under heavy loads (e.g. the application of high temperature/current/voltage and the significant change in temperature, etc.) may cause this product to decrease in the reliability significantly even if the operating conditions (i.e. operating temperature/current/voltage, etc.) are within the absolute maximum ratings and the operating ranges.

Please design the appropriate reliability upon reviewing the Toshiba Semiconductor Reliability Handbook ("Handling Precautions"/"Derating Concept and Methods") and individual reliability data (i.e. reliability test report and estimated failure rate, etc).

Note 1: Unit Rating

Note 2: Rating at mounting on a board  
(Glass epoxy board dimension : 30 mm × 30 mm, Copper pad area : 50 mm<sup>2</sup>)

## Electrical Characteristics

(Unless otherwise specified,  
 $V_{IN} = V_{OUT} + 1 \text{ V}$ ,  $I_{OUT} = 50 \text{ mA}$ ,  $C_{IN} = 0.1 \mu\text{F}$ ,  $C_{OUT} = 1.0 \mu\text{F}$ ,  $T_j = 25^\circ\text{C}$ )

Characteristics	Symbol	Test Condition	Min	Typ.	Max	Unit	
Output voltage	$V_{OUT}$	Please refer to the Output Voltage Accuracy table					
Line regulation	Reg·line	$V_{OUT} + 0.5 \text{ V} \leq V_{IN} \leq 6 \text{ V}$ , $I_{OUT} = 1 \text{ mA}$	—	3	15	mV	
Load regulation	Reg·load	$1 \text{ mA} \leq I_{OUT} \leq 150 \text{ mA}$	—	25	75	mV	
Quiescent current	$I_B$	$I_{OUT} = 0 \text{ mA}$	—	40	75	$\mu\text{A}$	
Stand-by current	$I_B$ (OFF)	$V_{CT} = 0 \text{ V}$	—	0.1	1.0	$\mu\text{A}$	
Output noise voltage	$V_{NO}$	$V_{IN} = V_{OUT} + 1 \text{ V}$ , $I_{OUT} = 10 \text{ mA}$ , $10 \text{ Hz} \leq f \leq 100 \text{ kHz}$ , $T_a = 25^\circ\text{C}$	TCR5SB15~TCR5SB20	—	25	—	$\mu\text{V}_{\text{rms}}$
			TCR5SB21~TCR5SB30	—	30	—	
			TCR5SB31~TCR5SB36	—	35	—	
			TCR5SB37~TCR5SB50	—	40	—	
Dropout voltage	$V_{IN}-V_{OUT}$	Please refer to the Dropout voltage table.					
Temperature coefficient	$T_{CVO}$	$-40^\circ\text{C} \leq T_{opr} \leq 85^\circ\text{C}$	—	100	—	ppm/ $^\circ\text{C}$	
Input voltage	$V_{IN}$	—	TCR5SB15~TCR5SB16	$V_{OUT} + 0.33 \text{ V}$	—	6.0	V
			TCR5SB17~TCR5SB18	$V_{OUT} + 0.31 \text{ V}$	—	6.0	
			TCR5SB19~TCR5SB23	$V_{OUT} + 0.25 \text{ V}$	—	6.0	
			TCR5SB24~TCR5SB27	$V_{OUT} + 0.20 \text{ V}$	—	6.0	
			TCR5SB28~TCR5SB50	$V_{OUT} + 0.19 \text{ V}$	—	6.0	
Ripple rejection ratio	R.R.	$V_{IN} = V_{OUT} + 1 \text{ V}$ , $I_{OUT} = 10 \text{ mA}$ , $f = 1 \text{ kHz}$ , $V_{\text{Ripple}} = 500 \text{ mV}_{\text{p-p}}$ , $T_a = 25^\circ\text{C}$	—	80	—	dB	
Control voltage (ON)	$V_{CT}$ (ON)	—	1.5	—	6.0	V	
Control voltage (OFF)	$V_{CT}$ (OFF)	—	0	—	0.25	V	
Control current (ON)	$I_{CT}$ (ON)	$V_{CT} = 6.0 \text{ V}$	—	—	0.1	$\mu\text{A}$	
Control current (OFF)	$I_{CT}$ (OFF)	$V_{CT} = 0.25 \text{ V}$	—	—	0.1	$\mu\text{A}$	

## Output Voltage Accuracy

( $V_{IN} = V_{OUT} + 1\text{ V}$ ,  $I_{OUT} = 50\text{ mA}$ ,  $C_{IN} = 0.1\text{ }\mu\text{F}$ ,  $C_{OUT} = 1.0\text{ }\mu\text{F}$ ,  $T_j = 25^\circ\text{C}$ )

Product No.	Symbol	Min	Typ.	Max	Unit
TCR5SB15	V <sub>OUT</sub>	1.47	1.5	1.53	V
*TCR5SB16		1.56	1.6	1.64	
*TCR5SB17		1.66	1.7	1.74	
TCR5SB18		1.76	1.8	1.84	
TCR5SB19		1.86	1.9	1.94	
*TCR5SB20		1.96	2.0	2.04	
*TCR5SB21		2.05	2.1	2.15	
*TCR5SB22		2.15	2.2	2.25	
*TCR5SB23		2.25	2.3	2.35	
*TCR5SB24		2.35	2.4	2.45	
TCR5SB25		2.45	2.5	2.55	
*TCR5SB26		2.54	2.6	2.66	
TCR5SB27		2.64	2.7	2.76	
TCR5SB28		2.74	2.8	2.86	
TCR5SB29		2.84	2.9	2.96	
TCR5SB30		2.94	3.0	3.06	
TCR5SB31		3.03	3.1	3.17	
*TCR5SB32		3.13	3.2	3.27	
TCR5SB33		3.23	3.3	3.37	
*TCR5SB34		3.33	3.4	3.47	
*TCR5SB35		3.43	3.5	3.57	
*TCR5SB36		3.52	3.6	3.68	
*TCR5SB37		3.62	3.7	3.78	
*TCR5SB38		3.72	3.8	3.88	
*TCR5SB39		3.82	3.9	3.98	
*TCR5SB40		3.92	4.0	4.08	
*TCR5SB41		4.01	4.1	4.19	
*TCR5SB42		4.11	4.2	4.29	
*TCR5SB43		4.21	4.3	4.39	
*TCR5SB44		4.31	4.4	4.49	
*TCR5SB45	4.41	4.5	4.59		
*TCR5SB46	4.50	4.6	4.70		
*TCR5SB47	4.60	4.7	4.80		
*TCR5SB48	4.70	4.8	4.90		
*TCR5SB49	4.80	4.9	5.00		
TCR5SB50	4.90	5.0	5.10		

Please contact us if prefer products with \* sign from above lists

## Dropout Voltage

( $I_{OUT} = 50 \text{ mA}$ ,  $C_{IN} = 0.1 \text{ }\mu\text{F}$ ,  $C_{OUT} = 1.0 \text{ }\mu\text{F}$ ,  $T_j = 25^\circ\text{C}$ )

Product No.	Symbol	Min	Typ.	Max	Unit
TCR5SB15~TCR5SB16	$V_{IN-V_{OUT}}$	—	150	330	mV
TCR5SB17~TCR5SB18		—	130	310	
TCR5SB19~TCR5SB23		—	110	250	
TCR5SB24~TCR5SB27		—	90	200	
TCR5SB28~TCR5SB50		—	85	190	

## Application Note

### 1. Recommended Application Circuit

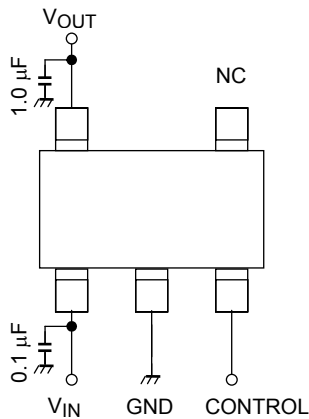

Control Level	Operation
HIGH	ON
LOW	OFF

The figure above shows the recommended configuration for using a Low-Dropout regulator. Insert a capacitor at Vout and Vin pins for stable input/output operation. (Ceramic capacitors can be used)

If the control function is not to be used, Toshiba recommend that the control pin is connected to the V<sub>IN</sub> pin.

### 2. Power Dissipation

Power dissipation of TCR5SBxx series is independent and shows in Absolute Maximum Ratings when it is mounted on the board. Testing size and pattern shows below.

### Testing Board of Thermal Resistance

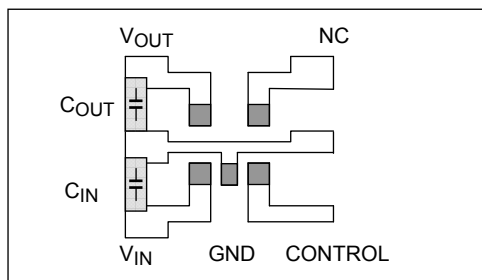

Board material: Glass Epoxy, Board dimension 30 mm × 30 mm  
Copper area: 50 mm<sup>2</sup>, t = 0.8 mm

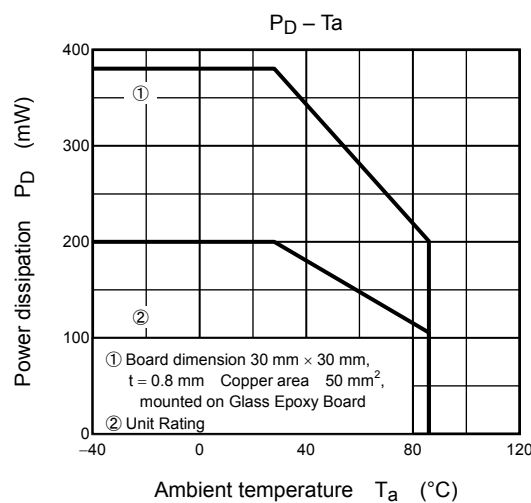

### 3. Ripple Rejection

TCR5SBxx series are designed for superior ripple rejection characteristic. Even an output changes with steep

resistance rate of the power supply voltage, characteristic of Input Transient Response, the ripple rejection shows an extremely superior characteristics. Therefore these devices are suitable for use as RF block for every cellular phone system.

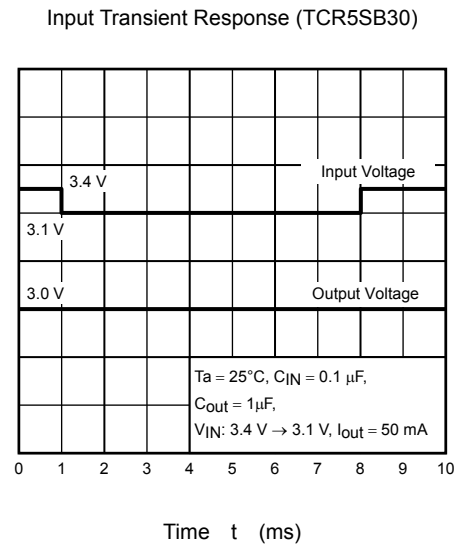
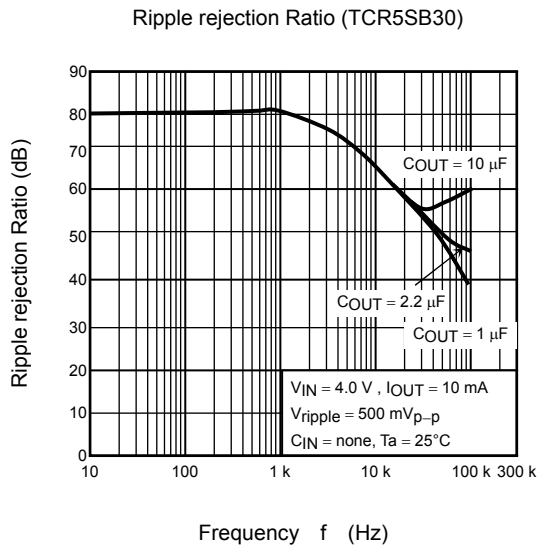

## Attention in Use

- Output Capacitors**

Ceramic capacitors can be used for these devices. However, because of the type of the capacitors, there might be unexpected thermal features. Please consider application condition for selecting capacitors. And Toshiba recommend the ESR of ceramic capacitor is under  $10 \Omega$ .
- Mounting**

The long distance between IC and output capacitor might affect phase assurance by impedance in wire and inductor. For stable power supply, output capacitor need to mount near IC as much as possible. Also GND pattern need to be large and make the wire impedance small as possible.
- Permissible Loss**

Please have enough design patterns for expected maximum permissible loss. And under consideration of surrounding temperature, input voltage, and output current etc, we recommend proper dissipation ratings for maximum permissible loss; in general maximum dissipation rating is 70 to 80 percent.
- Overcurrent Protection Circuit**

Overcurrent protection circuit is designed in these products, but this does not assure for the suppression of uprising device operation. If output pins and GND pins are shorted out, these products might be break down. In use of these products, please read through and understand dissipation idea for absolute maximum ratings from the above mention or our 'Semiconductor Reliability Handbook'. Then use these products under absolute maximum ratings in any condition. Furthermore, Toshiba recommend inserting failsafe system into the design.

## Representative Typical Characteristics

### 1) Output Voltage vs. Input Voltage

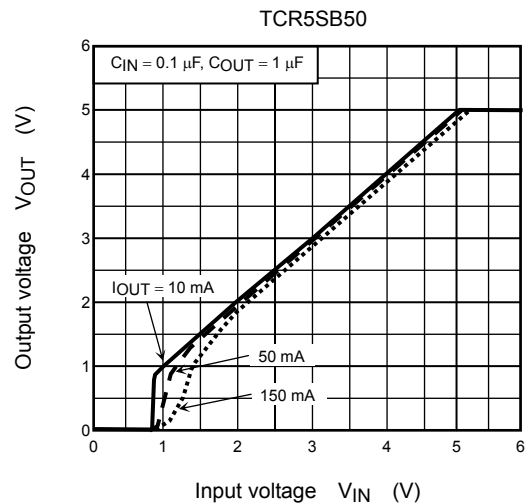
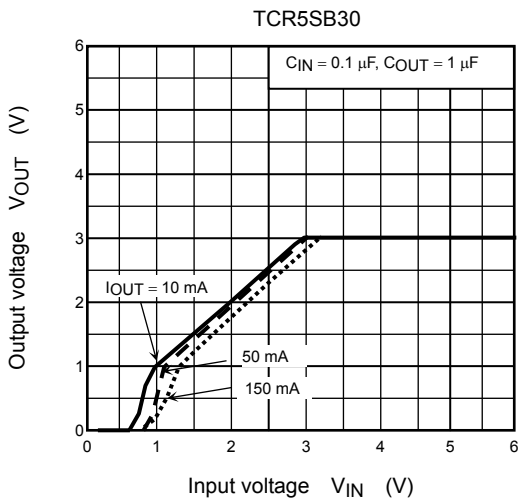
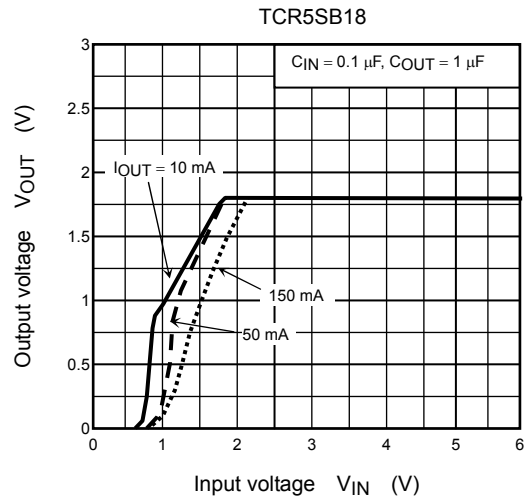
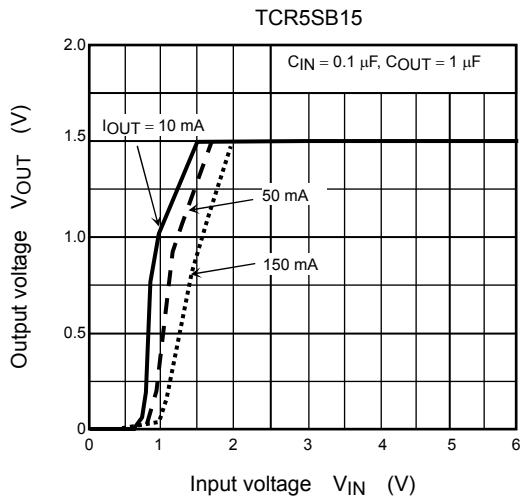

### 2) Output Voltage vs. Output Current

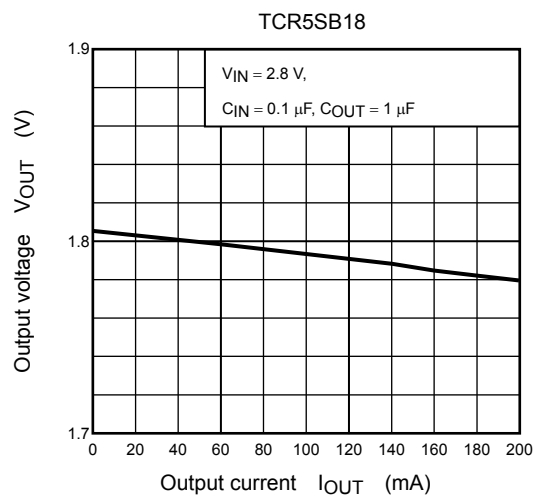
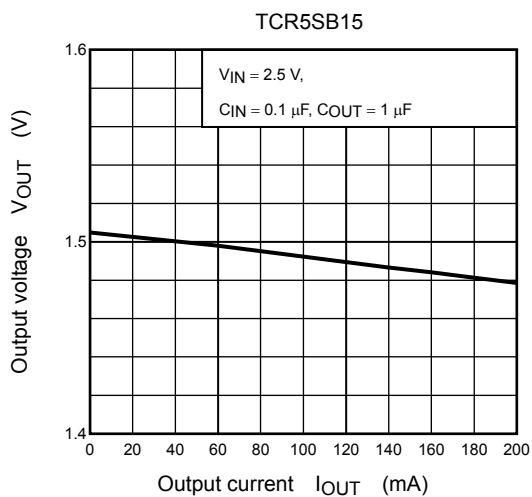



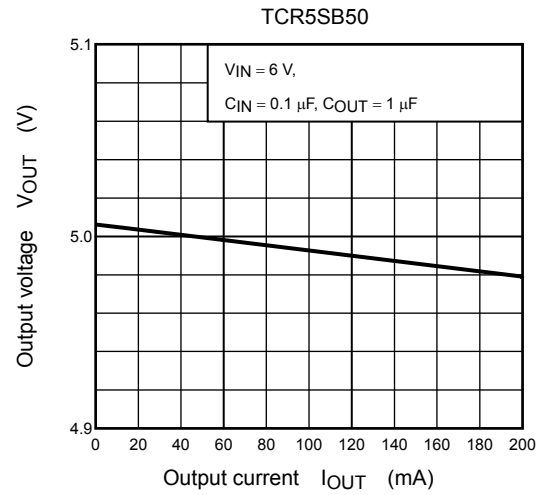
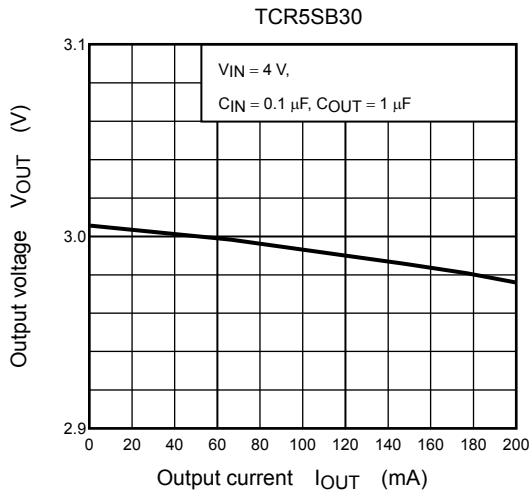

3) Output Voltage vs. Ambient temperature

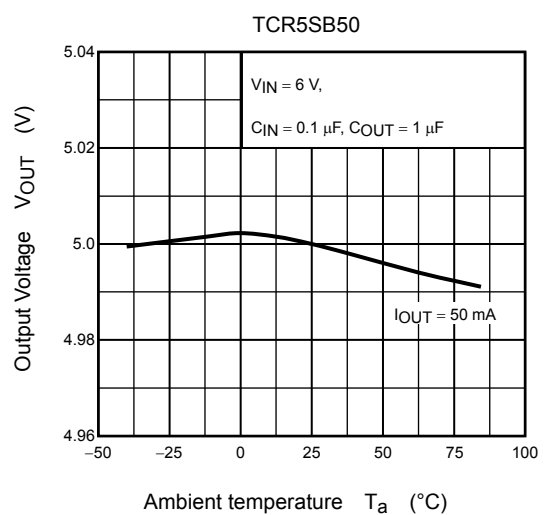
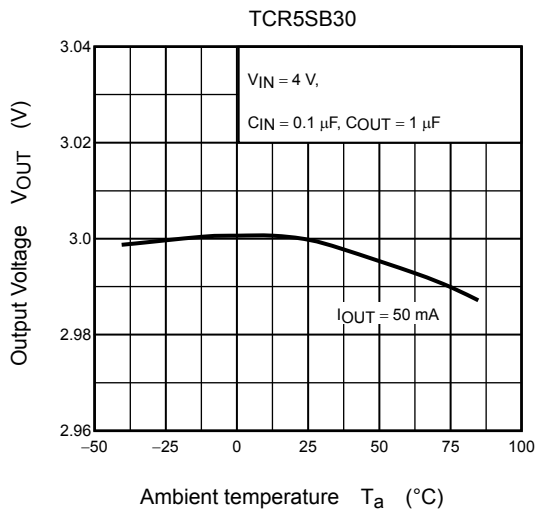
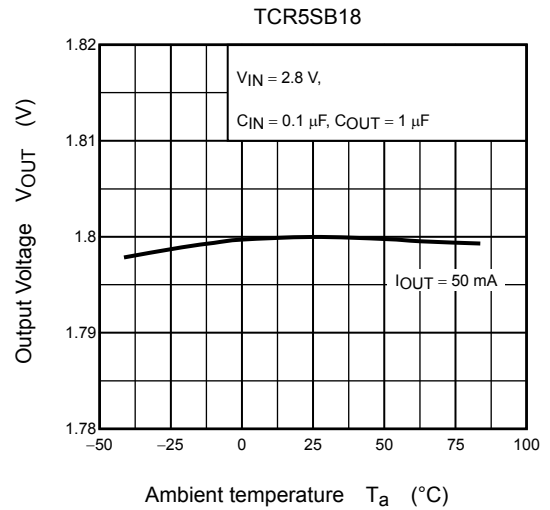
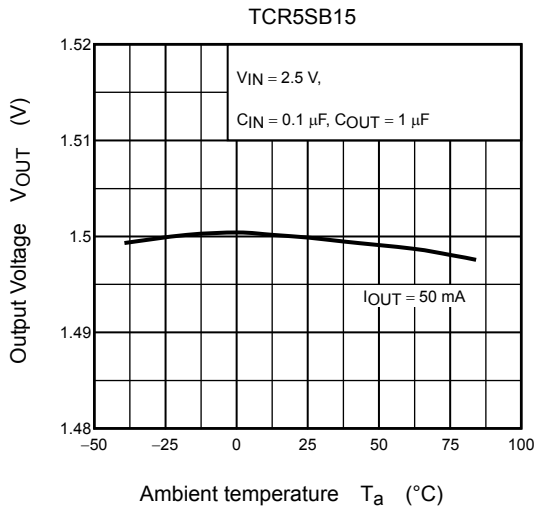

### 4) Dropout Voltage vs. Output Current

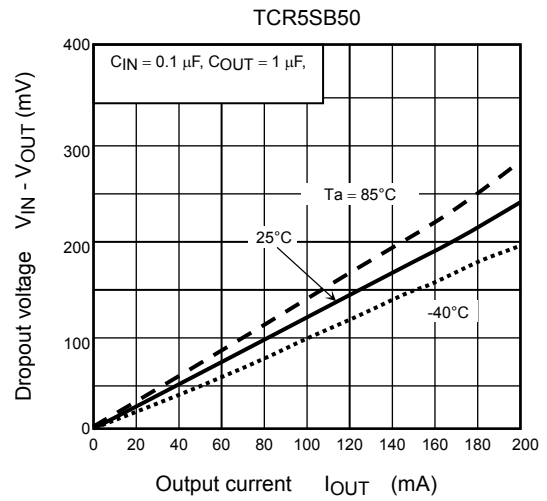
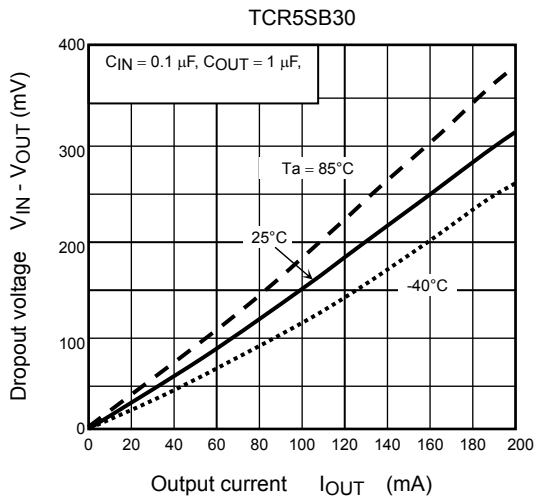

### 5) Quiescent Current vs. Input Voltage

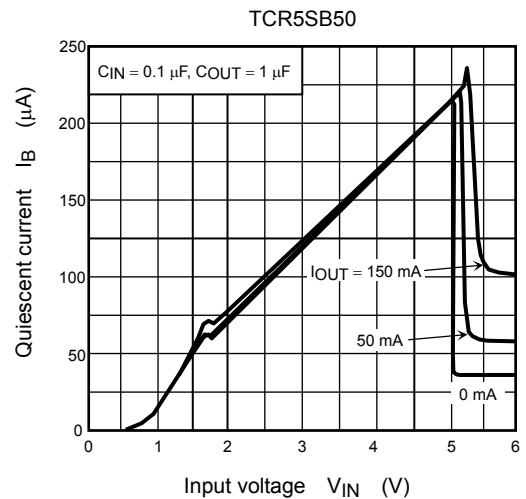
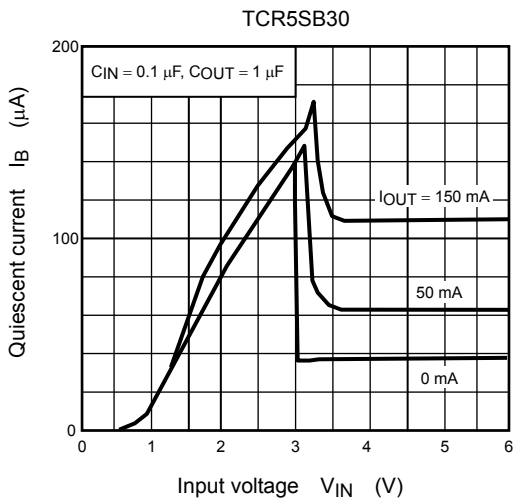
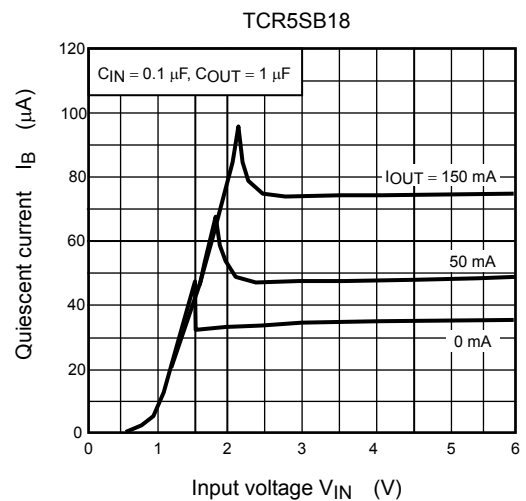
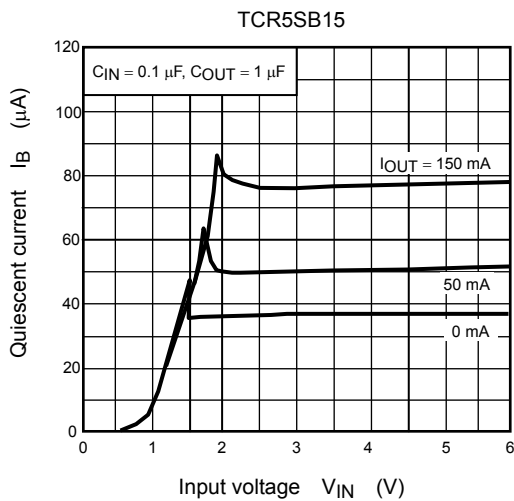

## 6) Quiescent Current vs. Ambient temperature

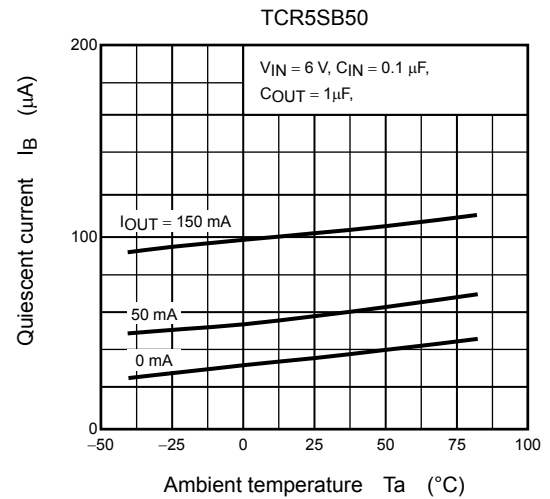
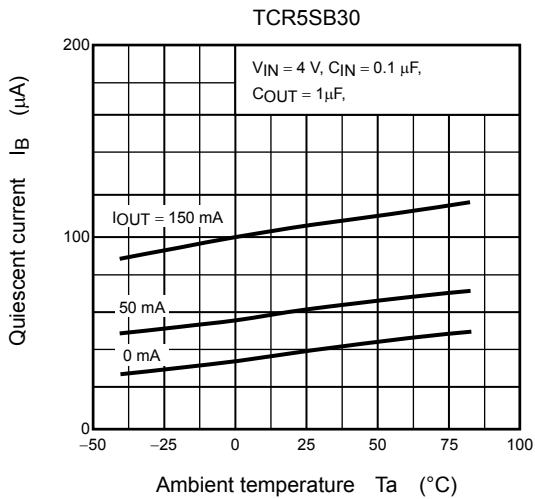
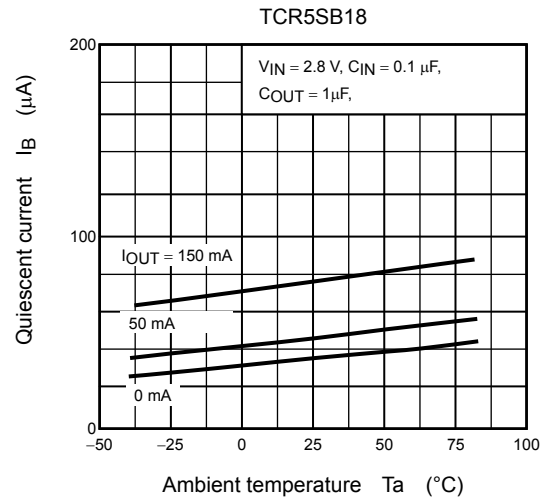
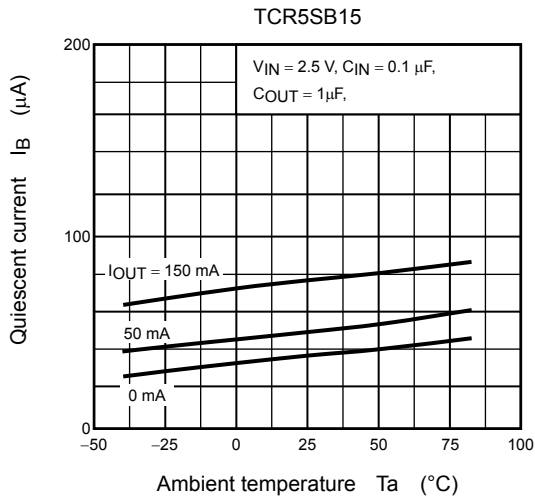

## 7) Overcurrent Protection Characteristics

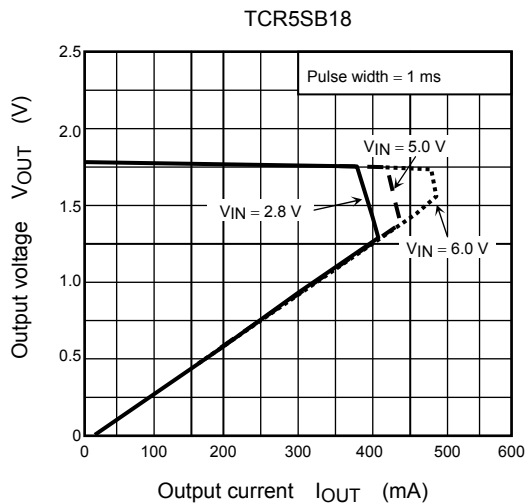

8) Ripple rejection Ratio vs. Frequency (Dependence of Output current)

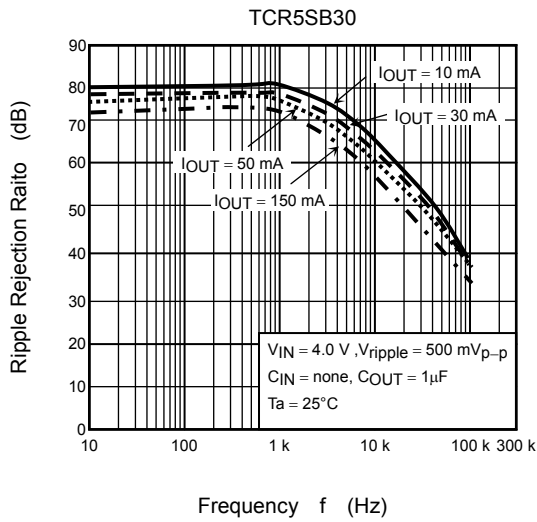

9) Ripple rejection Ratio vs. Input Voltage

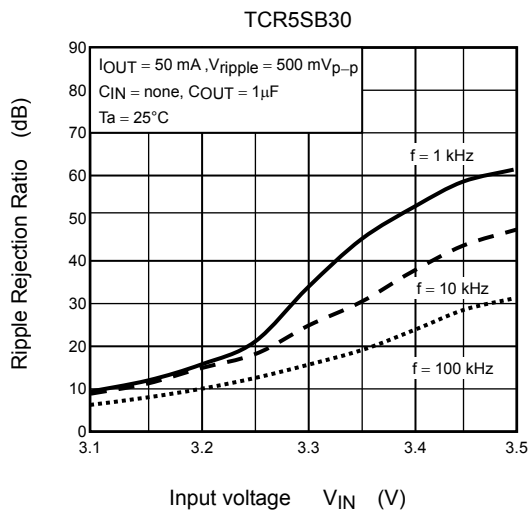
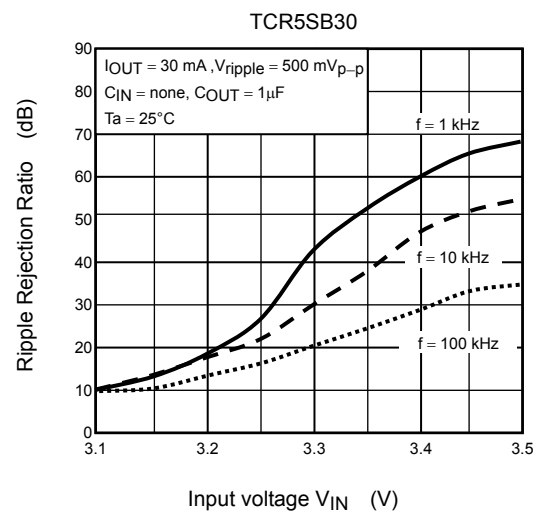
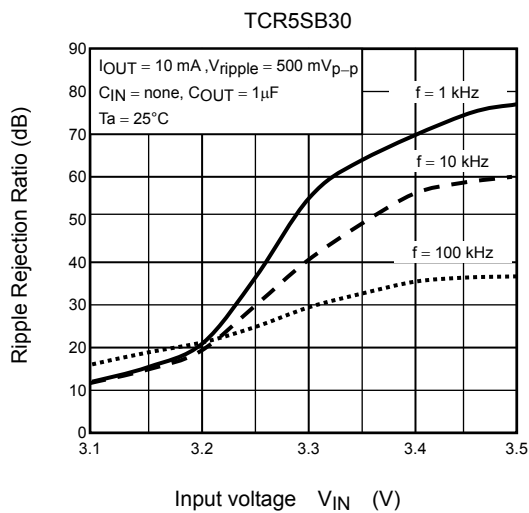

## 10) Control Transient Response

TCR5SB15 (Turn on wave form)

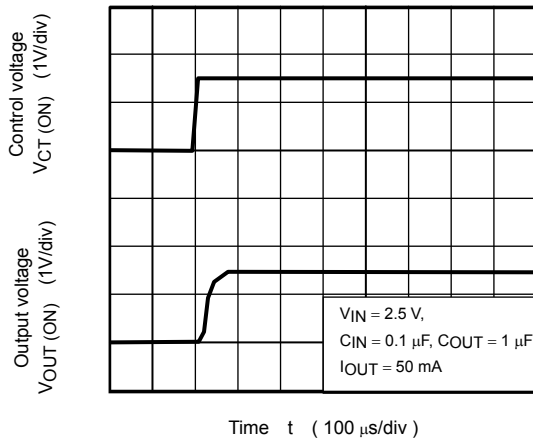

TCR5SB15 (Turn off wave form)

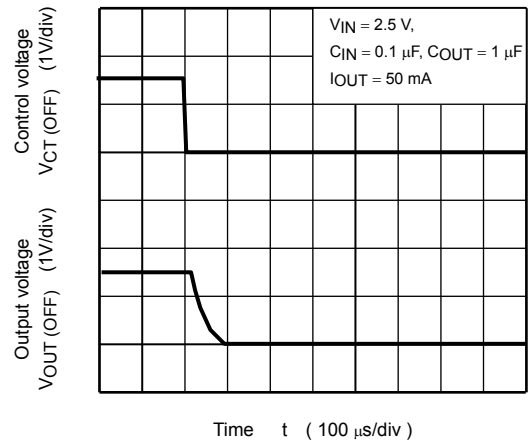

TCR5SB30 (Turn on wave form)

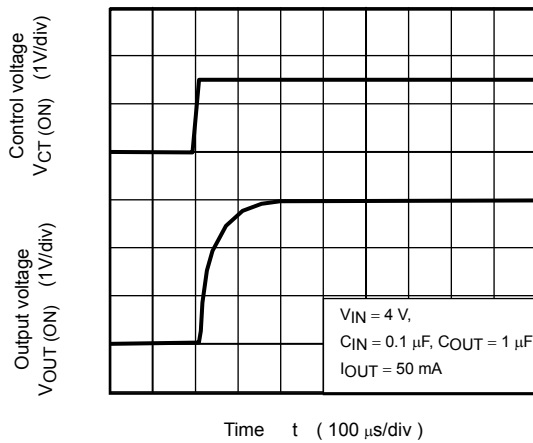

TCR5SB30 (Turn off wave form)

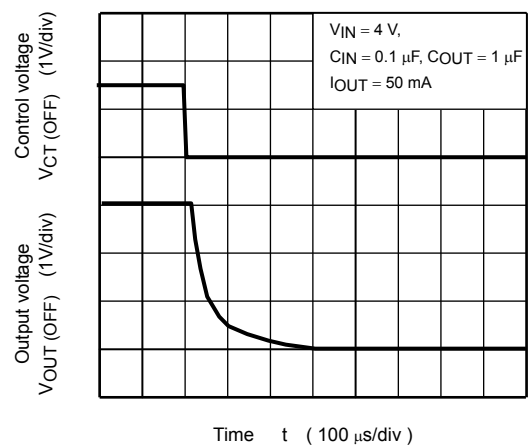

TCR5SB50 (Turn on wave form)

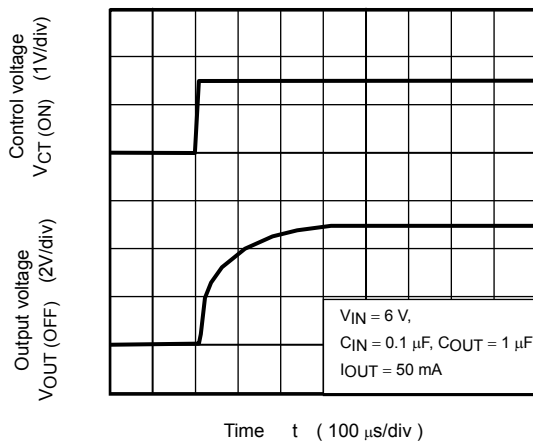

TCR5SB50 (Turn off wave form)

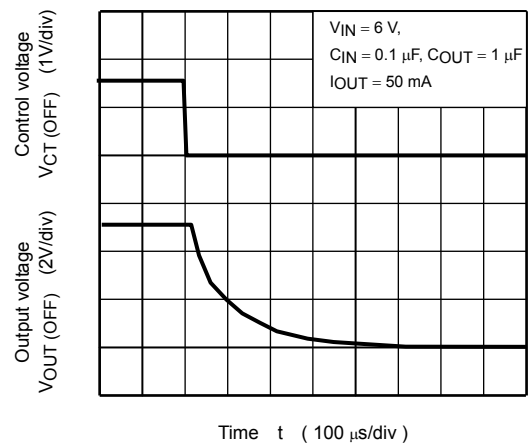

## 11) Load Transient Response

TCR5SB15 ( $I_{OUT} = 1m$  to  $30mA$ )

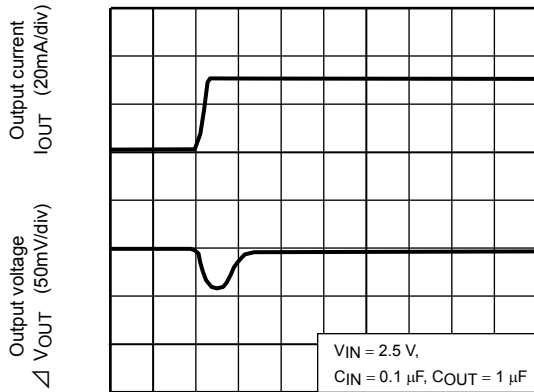

Time t ( 5  $\mu s$ /div )

TCR5SB15 ( $I_{OUT} = 30m$  to  $1mA$ )

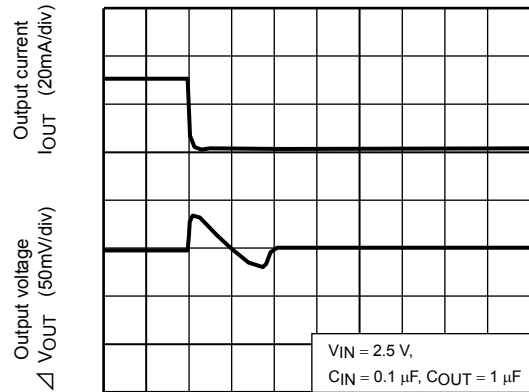

Time t ( 20  $\mu s$ /div )

TCR5SB15 ( $I_{OUT} = 50m$  to  $100mA$ )

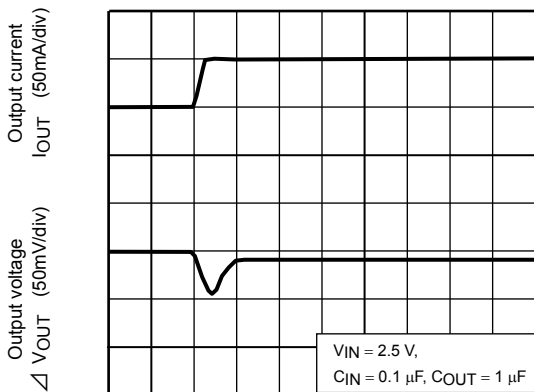

Time t ( 5  $\mu s$ /div )

TCR5SB15 ( $I_{OUT} = 100m$  to  $50mA$ )

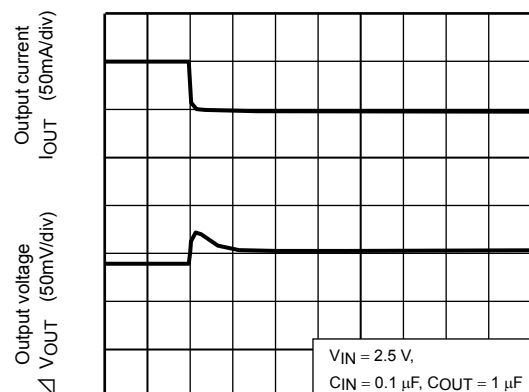

Time t ( 5  $\mu s$ /div )

TCR5SB30 ( $I_{OUT} = 1m$  to  $30mA$ )

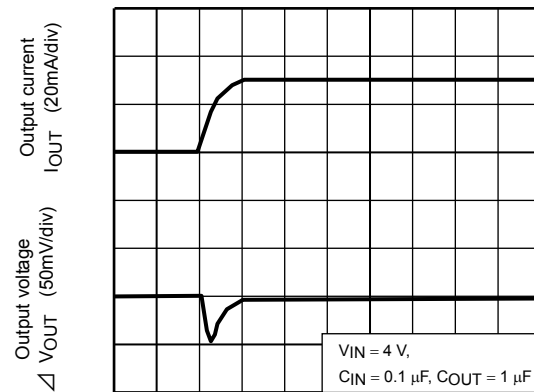

Time t ( 10  $\mu s$ /div )

TCR5SB30 ( $I_{OUT} = 30m$  to  $1mA$ )

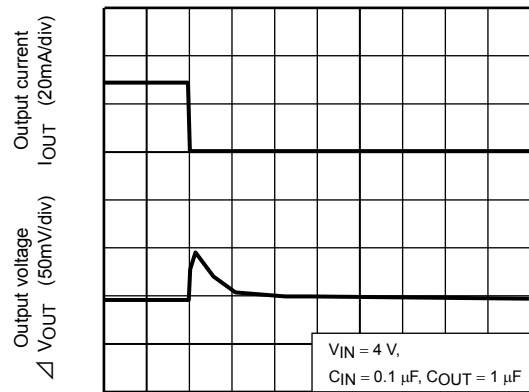

Time t ( 20  $\mu s$ /div )

TCR5SB30 ( $I_{OUT} = 50m$  to  $100mA$ )

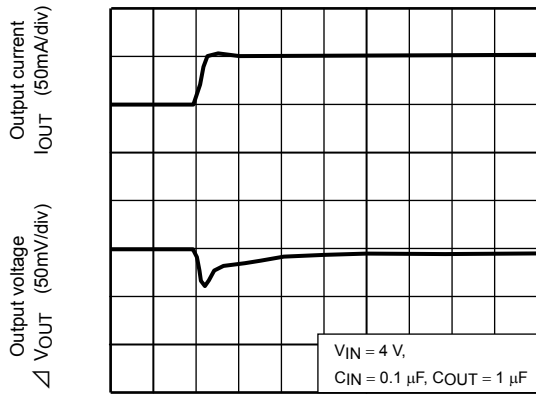

Time t (20  $\mu s$ /div)

TCR5SB30 ( $I_{OUT} = 100m$  to  $50mA$ )

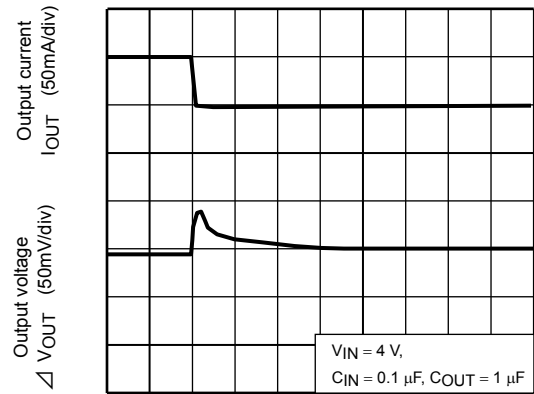

Time t (20  $\mu s$ /div)

TCR5SB50 ( $I_{OUT} = 1m$  to  $30mA$ )

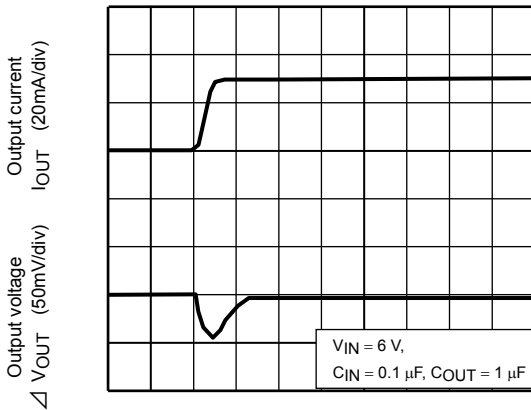

Time t (5  $\mu s$ /div)

TCR5SB50 ( $I_{OUT} = 30m$  to  $1mA$ )

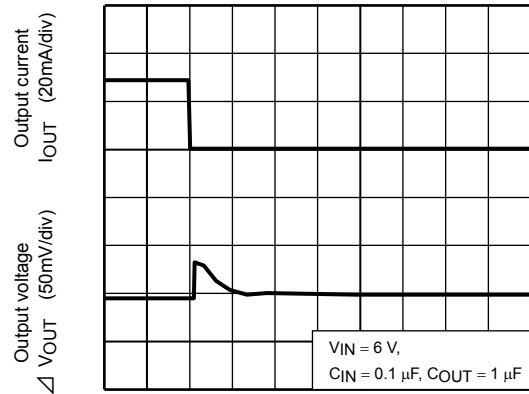

Time t (20  $\mu s$ /div)

TCR5SB50 ( $I_{OUT} = 50m$  to  $100mA$ )

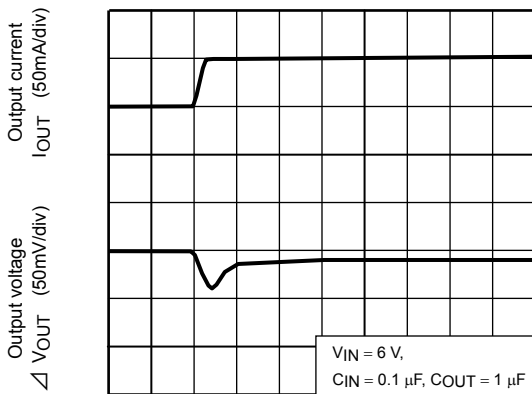

Time t (5  $\mu s$ /div)

TCR5SB50 ( $I_{OUT} = 100m$  to  $50mA$ )

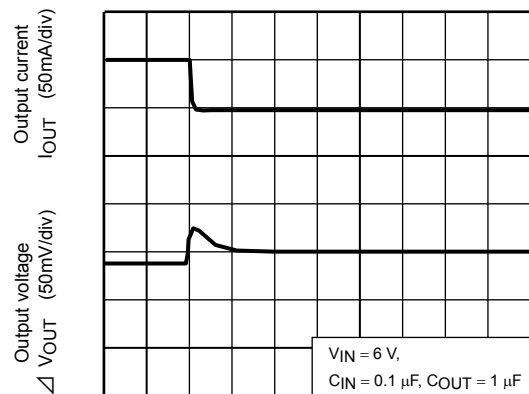

Time t (5  $\mu s$ /div)

## Package Dimensions

SSOP5-P-0.95

Unit : mm

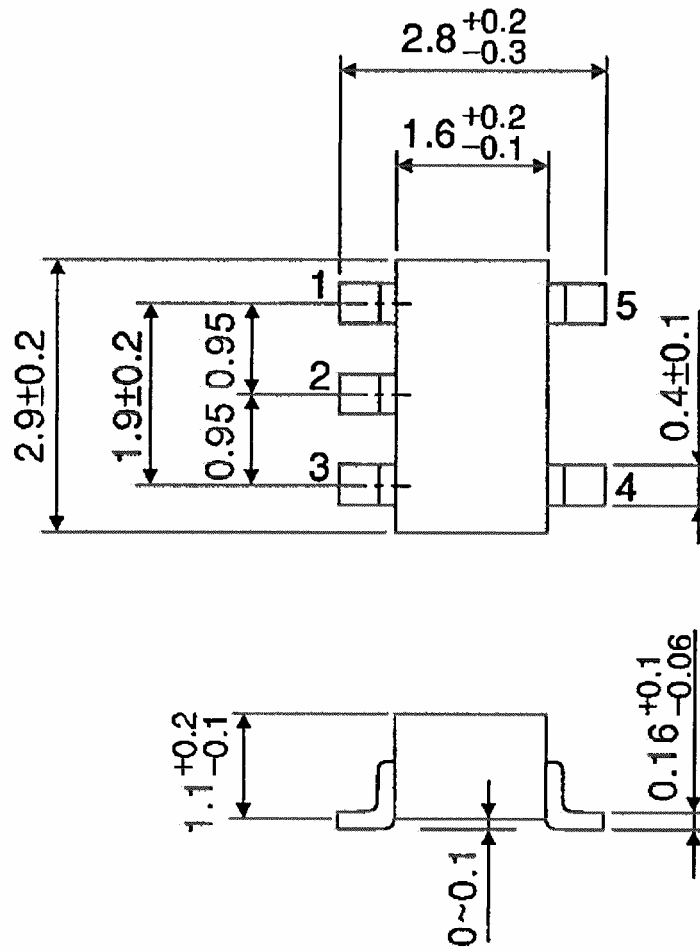

Weight: 0.016 g (typ)



**RESTRICTIONS ON PRODUCT USE**

20070701-EN GENERAL

- The information contained herein is subject to change without notice.
- TOSHIBA is continually working to improve the quality and reliability of its products. Nevertheless, semiconductor devices in general can malfunction or fail due to their inherent electrical sensitivity and vulnerability to physical stress. It is the responsibility of the buyer, when utilizing TOSHIBA products, to comply with the standards of safety in making a safe design for the entire system, and to avoid situations in which a malfunction or failure of such TOSHIBA products could cause loss of human life, bodily injury or damage to property.  
In developing your designs, please ensure that TOSHIBA products are used within specified operating ranges as set forth in the most recent TOSHIBA products specifications. Also, please keep in mind the precautions and conditions set forth in the "Handling Guide for Semiconductor Devices," or "TOSHIBA Semiconductor Reliability Handbook" etc.
- The TOSHIBA products listed in this document are intended for usage in general electronics applications (computer, personal equipment, office equipment, measuring equipment, industrial robotics, domestic appliances, etc.). These TOSHIBA products are neither intended nor warranted for usage in equipment that requires extraordinarily high quality and/or reliability or a malfunction or failure of which may cause loss of human life or bodily injury ("Unintended Usage"). Unintended Usage include atomic energy control instruments, airplane or spaceship instruments, transportation instruments, traffic signal instruments, combustion control instruments, medical instruments, all types of safety devices, etc.. Unintended Usage of TOSHIBA products listed in this document shall be made at the customer's own risk.
- The products described in this document shall not be used or embedded to any downstream products of which manufacture, use and/or sale are prohibited under any applicable laws and regulations.
- The information contained herein is presented only as a guide for the applications of our products. No responsibility is assumed by TOSHIBA for any infringements of patents or other rights of the third parties which may result from its use. No license is granted by implication or otherwise under any patents or other rights of TOSHIBA or the third parties.
- Please contact your sales representative for product-by-product details in this document regarding RoHS compatibility. Please use these products in this document in compliance with all applicable laws and regulations that regulate the inclusion or use of controlled substances. Toshiba assumes no liability for damage or losses occurring as a result of noncompliance with applicable laws and regulations.