

SILICON TRANSISTOR

2SA1610

HIGH SPEED SWITCHING

PNP SILICON EPITAXIAL TRANSISTOR

PACKAGE DIMENSIONS
in millimeters

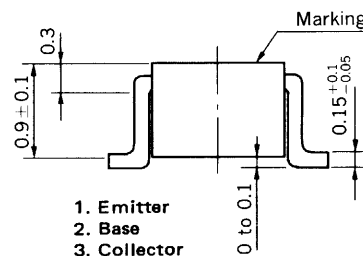
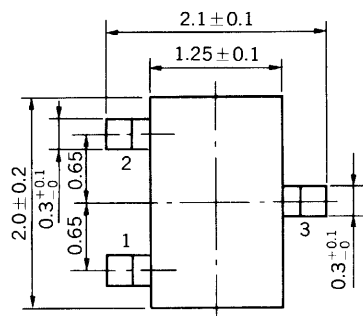

FEATURES

- High Speed Switching : $t_{on} = 9.0 \text{ ns TYP.}$
 $t_{off} = 19.0 \text{ ns TYP.}$
- High f_T : $f_T = 1\,800 \text{ MHz TYP.}$
- Low C_{ob} : $C_{ob} = 2.0 \text{ pF TYP.}$
- Complementary to 2SC4176

ABSOLUTE MAXIMUM RATINGS

Maximum Voltages and Current ($T_a = 25^\circ\text{C}$)

Collector to Base Voltage	V_{CBO}	-15	V
Collector to Emitter Voltage	V_{CEO}	-15	V
Emitter to Base Voltage	V_{EBO}	-4.5	V
Collector Current (DC)	I_C	-50	mA

Maximum Power Dissipation

Total power Dissipation at 25°C Ambient Temperature	P_T	150	mW
--	-------	-----	----

Maximum Temperatures

Junction Temperature	T_j	150	$^\circ\text{C}$
Storage Temperature Range	T_{stg}	-55 to +150	$^\circ\text{C}$

ELECTRICAL CHARACTERISTICS ($T_a = 25^\circ\text{C}$)

CHARACTERISTIC	SYMBOL	MIN.	TYP.	MAX.	UNIT	TEST CONDITIONS
Collector Cutoff Current	I_{CBO}			-100	nA	$V_{CB} = -8.0 \text{ V}, I_E = 0$
Emitter Cutoff Current	I_{EBO}			-100	nA	$V_{EB} = -3.0 \text{ V}, I_C = 0$
DC Current Gain	h_{FE1}^*	30	70			$V_{CE} = -1.0 \text{ V}, I_C = -1.0 \text{ mA}$
DC Current Gain	h_{FE2}^*	50	80	150		$V_{CE} = -1.0 \text{ V}, I_C = -10 \text{ mA}$
Collector Saturation Voltage	$V_{CE(sat)}^*$		-0.09	-0.20	V	$I_C = -10 \text{ mA}, I_B = -1.0 \text{ mA}$
Base Saturation Voltage	$V_{BE(sat)}^*$		-0.80	-0.95	V	$I_C = -10 \text{ mA}, I_B = -1.0 \text{ mA}$
Gain Bandwidth Product	f_T	800	1800		MHz	$V_{CE} = -10 \text{ V}, I_E = 10 \text{ mA}$
Output Capacitance	C_{ob}		2.0	3.0	pF	$V_{CB} = -5.0 \text{ V}, I_E = 0, f = 1.0 \text{ MHz}$
Turn-on Time	t_{on}		9.0	20	ns	See Test Circuit
Storage Time	t_{stg}		16	40	ns	
Turn-off Time	t_{off}		19	40	ns	

* Pulsed: $PW \leq 350 \mu\text{s}$, Duty Cycle $\leq 2\%$

h_{FE2} Classification

Making	Y33	Y34
h_{FE2}	50 to 100	75 to 150

TYPICAL CHARACTERISTICS ($T_a = 25^\circ\text{C}$)

TOTAL POWER DISSIPATION vs. AMBIENT TEMPERATURE

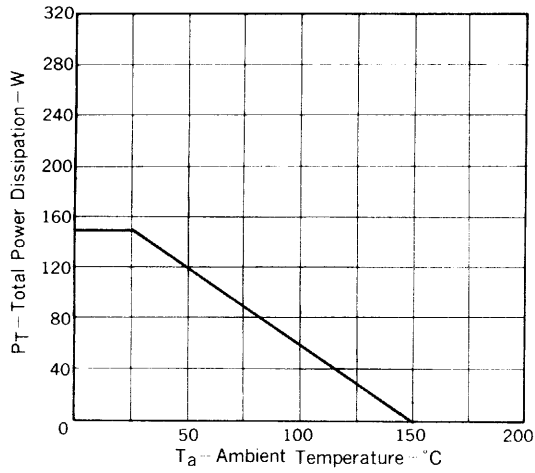

COLLECTOR CURRENT vs. COLLECTOR TO EMITTER VOLTAGE

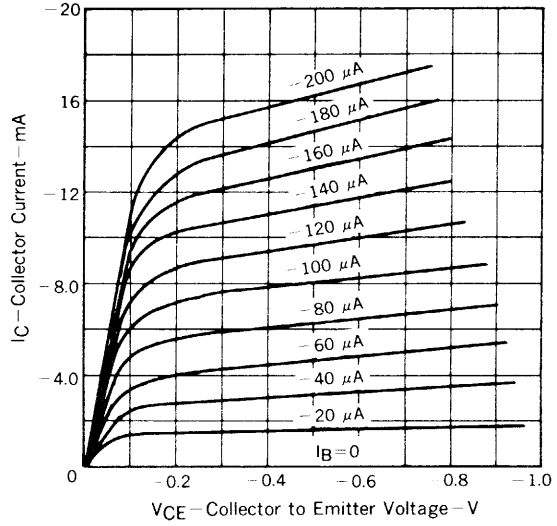

COLLECTOR CURRENT vs. BASE TO EMITTER VOLTAGE

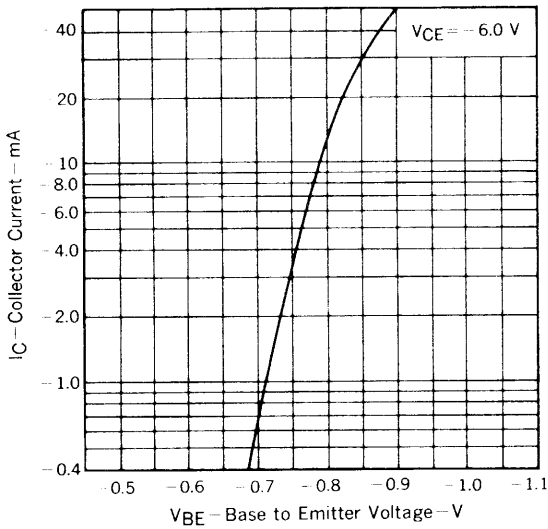

DC CURRENT GAIN vs. COLLECTOR CURRENT

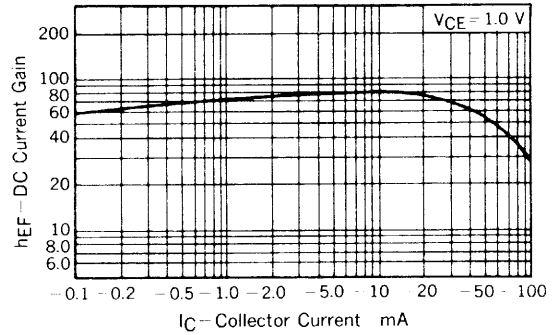

BASE AND COLLECTOR SATURATION VOLTAGE vs. COLLECTOR CURRENT

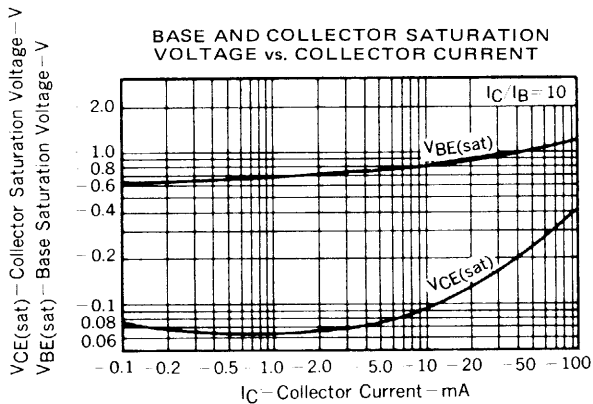

INPUT AND OUTPUT CAPACITANCE vs. REVERSE VOLTAGE

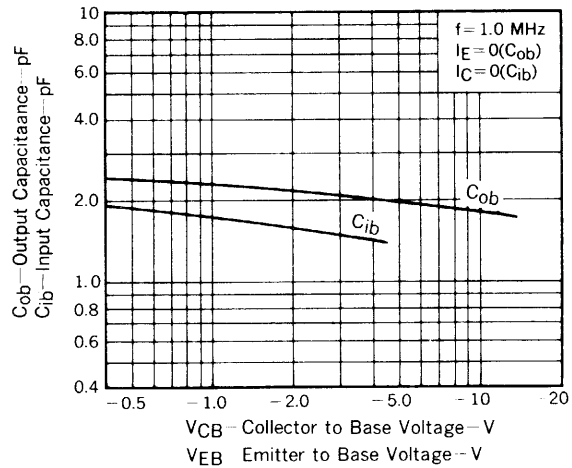

GAIN BANDWIDTH PRODUCT vs. EMITTER CURRENT

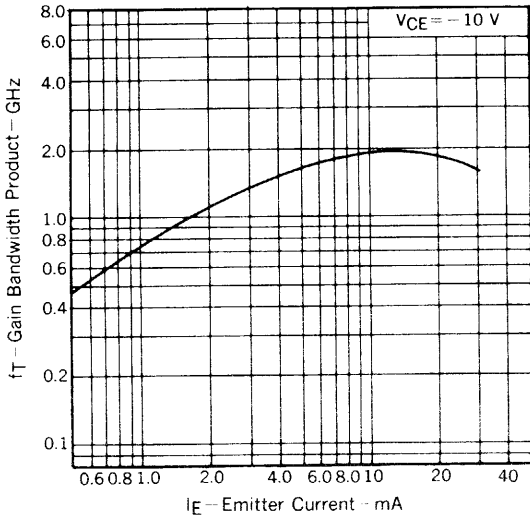

SWITCHING TIME vs. COLLECTOR CURRENT

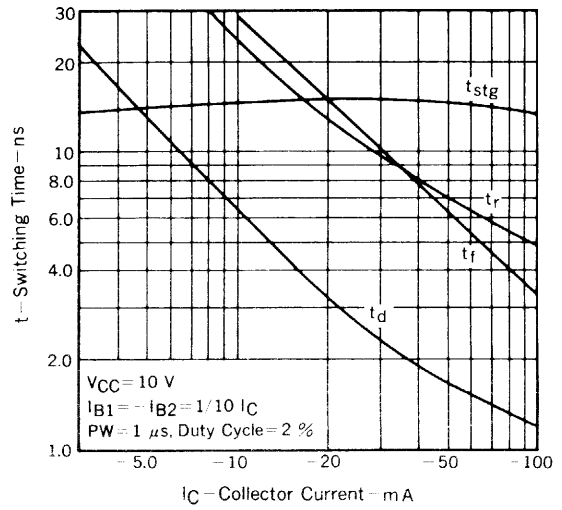

SWITCHING TIME TEST CIRCUIT

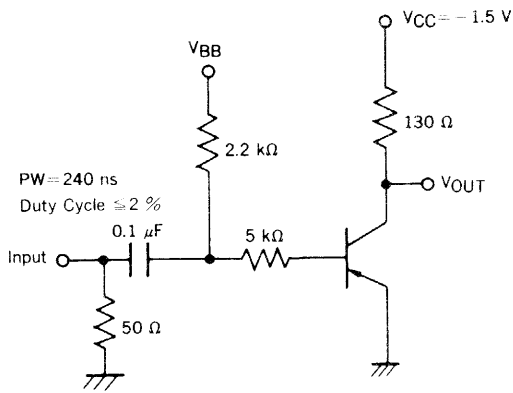

t_{on} , t_{off} Switching

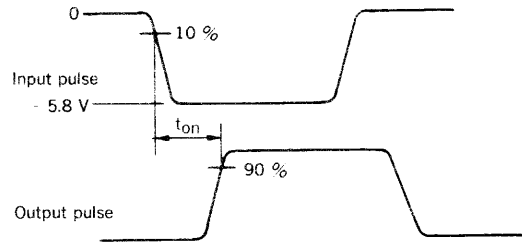

t_{on} Voltage Waveforms ($V_{BB} = \text{GROUND}$)

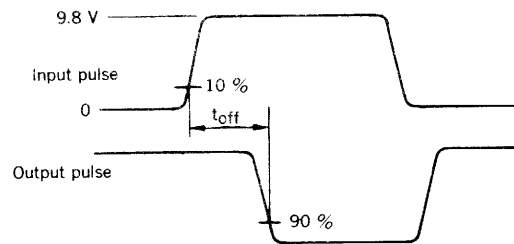

t_{off} Voltage Waveforms ($V_{BB} = -8.0 \text{ V}$)

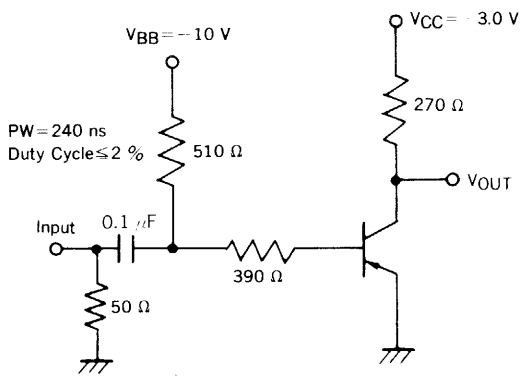

t_{stg} Switching

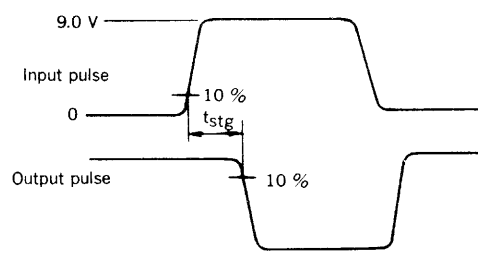

t_{stg} Voltage Waveforms

