

4.8 V NPN Common Emitter Medium Power Output Transistor

Technical Data

AT-31625

Features

- 4.8 Volt Operation
- +28.0 dBm P_{out} @ 900 MHz, Typ.
- 70% Collector Efficiency @ 900 MHz, Typ.
- 9 dB Power Gain @ 900 MHz, Typ.
- -31 dBc IMD_3 @ P_{out} of 21 dBm per Tone, 900 MHz, Typ.
- 50% Smaller than SOT-223 Package

Applications

- Medium Power Driver Device for Cellular/PCS, ISM 900, WLAN
- Output Power Device for ISM 900, Cordless, WLAN

MSOP-3 Surface Mount Plastic Package Outline 25

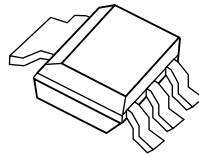

Pin Configuration

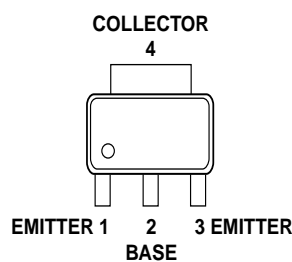

Description

Hewlett Packard's AT-31625 is a low cost, NPN medium power silicon bipolar junction transistor housed in a miniature, MSOP-3 surface mount plastic package. The AT-31625 can be used as a driver device or an output device, depending on the specific application. The AT-31625 features +28 dBm CW output power when operated at 4.8 volts. Excellent gain and superior efficiency make the AT-31625 ideal for use in battery powered systems.

The AT-31625 is fabricated with Hewlett Packard's 10 GHz F_t Self-Aligned-Transistor (SAT) process. The die are nitride passivated for surface protection. Excellent device uniformity, performance and reliability are produced by the use of ion-implantation, self-alignment techniques, and gold metalization in the fabrication of these devices.

AT-31625 Absolute Maximum Ratings

Symbol	Parameter	Units	Absolute Maximum ^[1]
V _{EBO}	Emitter-Base Voltage	V	1.4
V _{CBO}	Collector-Base Voltage	V	16.0
V _{CEO}	Collector-Emitter Voltage	V	9.5
I _C	Collector Current	mA	320
P _T	Power Dissipation ^[2]	W	1.0
T _j	Junction Temperature	°C	150
T _{STG}	Storage Temperature	°C	-65 to 150

Thermal Resistance^[3]:

$$\theta_{jc} = 65^{\circ}\text{C/W}$$

Notes:

1. Permanent damage may occur if any of these limits are exceeded.
2. Derate at 15.4 mW/°C for T_c > 85°C. T_c is defined to be the temperature of the collector pin 4, where the lead contacts the circuit board.
3. Using the liquid crystal technique, V_{CE} = 4.8 V, I_C = 50 mA, T_j = 150°C, 1-2 μm "hot-spot" resolution.

Electrical Specifications, T_C = 25°C

Symbol	Parameters and Test Conditions	Units	Min.	Typ.	Max.
	Freq. = 900 MHz, V _{CE} = 4.8 V, I _{CQ} = 5 mA, CW operation, Test Circuit A, unless otherwise specified				
P _{out}	Output Power ^[1] P _{in} = +19 dBm	dBm	+27.0	+28.0	
η _C	Collector Efficiency ^[1] P _{in} = +19 dBm	%	55	70	
IMD ₃	3rd Order Intermodulation Distortion, 2 Tone Test, P _{out} each Tone = +21 dBm ^[1] F1 = 899 MHz F2 = 901 MHz	dBc		-31	
	Mismatch Tolerance, No Damage ^[1] P _{out} = +28 dBm any phase, 2 sec duration				7:1
BV _{EBO}	Emitter-Base Breakdown Voltage I _E = 0.2 mA, open collector	V	1.4		
BV _{CBO}	Collector-Base Breakdown Voltage I _C = 1.0 mA, open emitter	V	16.0		
BV _{CEO}	Collector-Emitter Breakdown Voltage I _C = 5.0 mA, open base	V	9.5		
h _{FE}	Forward Current Transfer Ratio V _{CE} = 3 V, I _C = 180 mA	—	80	150	330
I _{CEO}	Collector Leakage Current V _{CEO} = 5 V	μA			15

Note:

1. With external matching on input and output, tested in a 50 ohm environment. Refer to Test Circuit A.

AT-31625 Typical Performance, $T_C = 25^\circ\text{C}$

Frequency = 900 MHz, $V_{CE} = 4.8\text{ V}$, $I_{CQ} = 5\text{ mA}$, CW operation, Test Circuit A, unless otherwise specified.

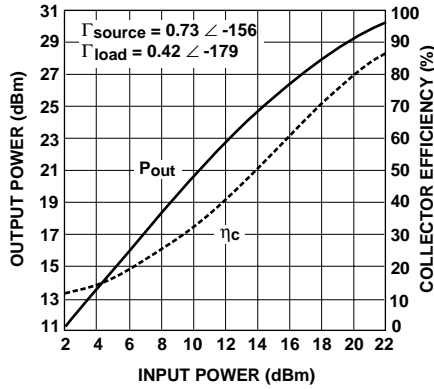

Figure 1. Output Power and Collector Efficiency vs. Input Power.

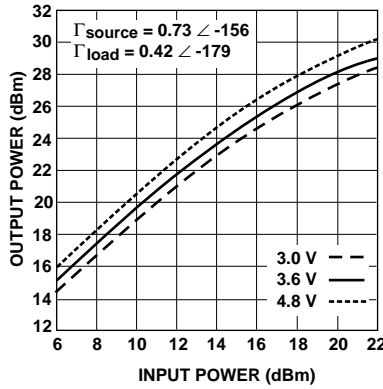

Figure 2. Output Power vs. Input Power Over Bias Voltage.

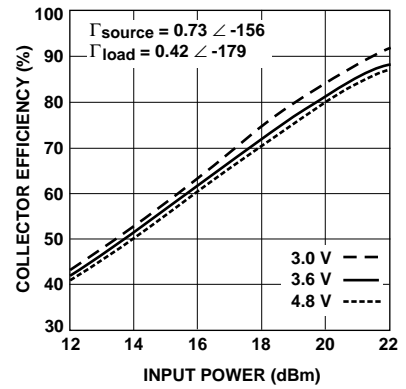

Figure 3. Collector Efficiency vs. Input Power Over Bias Voltage.

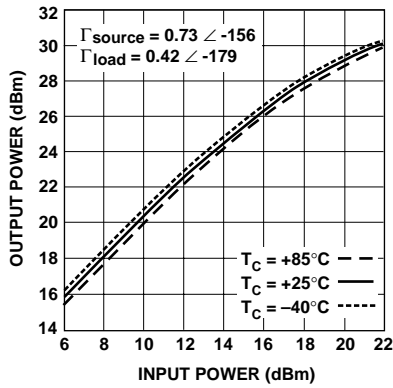

Figure 4. Output Power vs. Input Power Over Temperature.

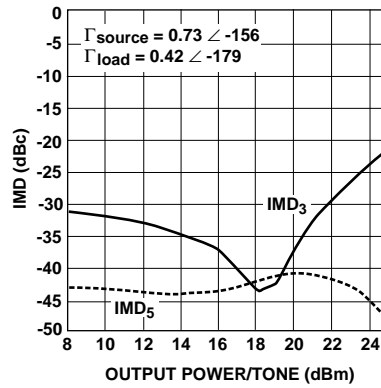

Figure 5. IMD₃, IMD₅ vs. Output Power Per Tone.

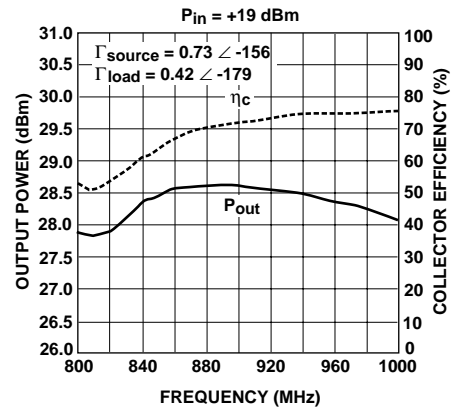

Figure 6. Output Power and Collector Efficiency vs. Frequency.
Note: Tuned at 900 MHz, then Swept over Frequency.

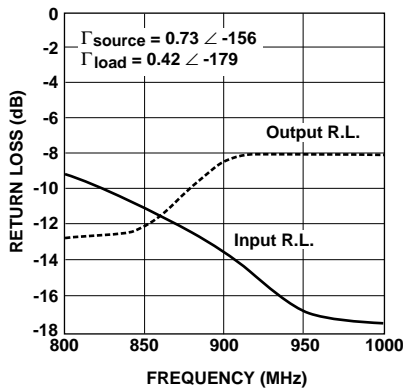

Figure 7. Input and Output Return Loss vs. Frequency.

AT-31625 Typical Large Signal Impedances

$V_{CE} = 4.8\text{ V}$, $I_{CQ} = 5\text{ mA}$, $P_{out} = +28.0\text{ dBm}$

Freq. MHz	Γ_{source}		Γ_{load}	
	Mag.	Ang.	Mag.	Ang.
800	0.661	-149.0	0.382	-171.3
825	0.679	-150.6	0.394	-172.8
850	0.697	-152.4	0.403	-174.6
875	0.712	-154.2	0.412	-176.5
900	0.727	-155.8	0.422	-179.0
925	0.740	-157.5	0.426	179.3
950	0.754	-159.0	0.432	177.2
975	0.767	-160.4	0.437	174.9
1000	0.777	-162.1	0.438	172.5

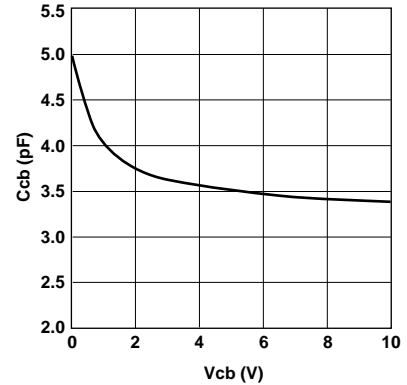
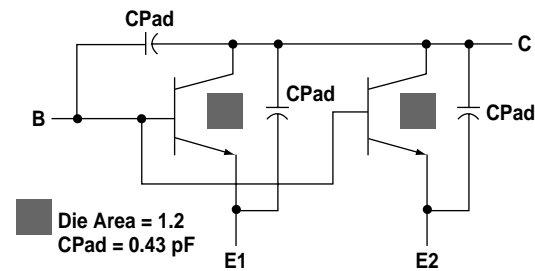

Figure 8. Collector-Base Capacitance vs. Collector-Base Voltage (DC Test).

SPICE Model Parameters

Die Model



Label	Value	Label	Value
BF	150	TR	1E-9
IKF	299.9	EG	1.11
ISE	9.9E-11	IS	3.598E-15
NE	2.399	XTI	3
VAF	33.16	CJC	1.4E-12
NF	0.9935	VJC	0.4776
TF	1.6E-11	MJC	0.2508
XTF	0.006656	XCJC	0.001
VTF	0.02785	FC	0.999
ITF	0.001	CJE	5.06E-12
PTF	23	VJE	1.148
XTB	0	MJE	0.5965
BR	54.61	RB	0.752
IKR	81	IRB	0
ISC	8.7E-13	RBM	0.01
NC	1.587	RE	2.488
VAR	1.511	RC	1.288
NR	0.9886		

Packaged Model

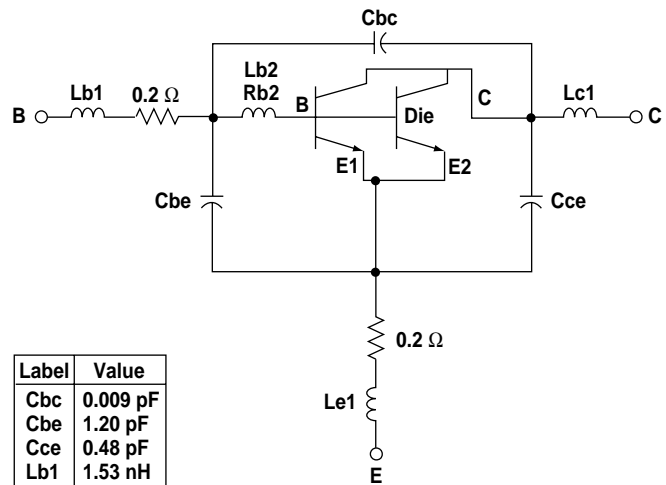

Label	Value
Cbc	0.009 pF
Cbe	1.20 pF
Cce	0.48 pF
Lb1	1.53 nH
Lb2	0.045 nH
Rb2	0.1 Ω
Le1	0.38 nH
Lc1	0.47 nH

AT-31625 Typical Scattering Parameters, Common Emitter, $Z_0 = 50 \Omega$

$V_{CE} = 3.0 \text{ V}, I_c = 200 \text{ mA}, T_c = 25^\circ\text{C}$

Freq. GHz	S_{11}		dB	S_{21}		dB	S_{12}		S_{22}	
	Mag.	Ang.		Mag.	Ang.		Mag.	Ang.	Mag.	Ang.
0.05	0.72	-150	30.7	34.19	113	-34.0	0.02	40	0.56	-120
0.10	0.77	-166	25.3	18.43	99	-34.0	0.02	42	0.52	-148
0.25	0.79	179	17.5	7.54	86	-28.0	0.04	57	0.51	-169
0.50	0.79	169	11.6	3.81	74	-23.1	0.07	64	0.51	-178
0.75	0.79	161	8.2	2.58	65	-20.9	0.09	63	0.52	177
0.90	0.79	156	6.7	2.17	59	-19.2	0.11	62	0.52	175
1.00	0.79	153	5.9	1.97	56	-18.4	0.12	61	0.52	174
1.25	0.79	146	4.1	1.61	48	-16.5	0.15	58	0.53	170
1.50	0.79	140	2.7	1.37	40	-14.9	0.18	54	0.54	167
1.75	0.79	133	1.7	1.21	32	-13.6	0.21	49	0.54	164
2.00	0.79	126	0.7	1.09	26	-12.8	0.23	45	0.55	160
2.25	0.79	120	0.0	1.00	19	-11.7	0.26	41	0.55	156
2.50	0.79	114	-0.6	0.93	13	-11.1	0.28	36	0.56	152

$V_{CE} = 3.6 \text{ V}, I_c = 200 \text{ mA}, T_c = 25^\circ\text{C}$

0.05	0.71	-148	31.2	36.39	114	-34.0	0.02	41	0.56	-117
0.10	0.76	-165	25.9	19.69	100	-34.0	0.02	43	0.51	-146
0.25	0.78	180	18.1	8.06	86	-28.0	0.04	57	0.50	-168
0.50	0.78	169	12.2	4.07	75	-24.4	0.06	64	0.50	-177
0.75	0.78	161	8.8	2.75	65	-20.9	0.09	64	0.51	178
0.90	0.78	156	7.3	2.31	60	-19.2	0.11	62	0.51	176
1.00	0.78	153	6.4	2.10	56	-18.4	0.12	61	0.51	174
1.25	0.78	146	4.7	1.71	48	-16.5	0.15	58	0.52	171
1.50	0.78	140	3.3	1.46	40	-14.9	0.18	54	0.53	168
1.75	0.78	133	2.1	1.28	33	-14.0	0.20	50	0.54	164
2.00	0.78	127	1.3	1.16	26	-12.8	0.23	46	0.54	161
2.25	0.78	121	0.4	1.05	19	-11.7	0.26	41	0.55	157
2.50	0.78	115	-0.2	0.98	13	-11.1	0.28	37	0.55	153

$V_{CE} = 4.8 \text{ V}, I_c = 200 \text{ mA}, T_c = 25^\circ\text{C}$

0.05	0.70	-145	31.7	38.47	115	-34.0	0.02	41	0.56	-114
0.10	0.75	-164	26.4	20.90	100	-34.0	0.02	43	0.50	-144
0.25	0.77	-180	18.7	8.57	87	-28.0	0.04	57	0.49	-167
0.50	0.77	169	12.7	4.33	75	-24.4	0.06	64	0.49	-176
0.75	0.77	161	9.3	2.92	66	-20.9	0.09	64	0.49	179
0.90	0.77	157	7.8	2.45	60	-19.2	0.11	62	0.50	176
1.00	0.77	154	7.0	2.23	57	-18.4	0.12	61	0.50	175
1.25	0.77	147	5.2	1.81	48	-16.5	0.15	58	0.51	172
1.50	0.77	140	3.8	1.54	41	-14.9	0.18	54	0.51	168
1.75	0.77	134	2.6	1.35	33	-14.0	0.20	50	0.52	165
2.00	0.77	127	1.7	1.22	27	-12.8	0.23	46	0.53	162
2.25	0.77	121	0.9	1.11	20	-12.0	0.25	41	0.54	158
2.50	0.77	115	0.3	1.03	13	-11.1	0.28	37	0.54	154

Typical Performance

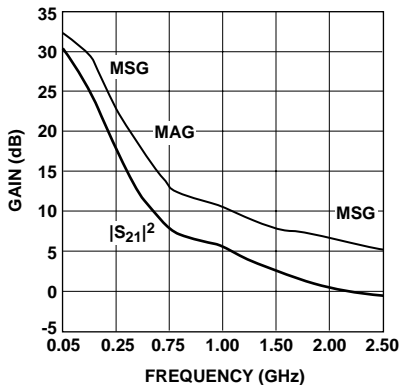

Figure 9. Insertion Power Gain, Maximum Available Gain, and Maximum Stable Gain vs. Frequency. $V_{CE} = 3.0\text{V}$, $I_c = 200 \text{ mA}$.

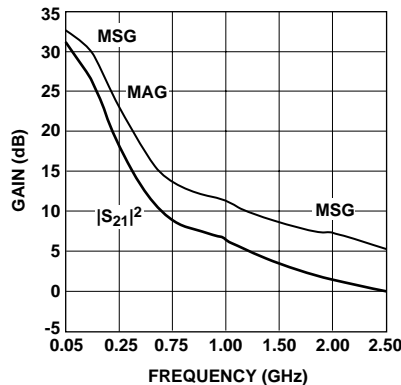

Figure 10. Insertion Power Gain, Maximum Available Gain, and Maximum Stable Gain vs. Frequency. $V_{CE} = 3.6\text{V}$, $I_c = 200 \text{ mA}$.

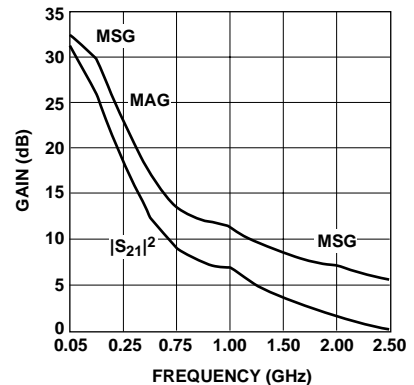

Figure 11. Insertion Power Gain, Maximum Available Gain, and Maximum Stable Gain vs. Frequency. $V_{CE} = 4.8\text{V}$, $I_c = 200 \text{ mA}$.

AT-31625 Typical Performance, $T_C = 25^\circ\text{C}$

Frequency = 1800 MHz, $V_{CE} = 4.8\text{ V}$, $I_{CQ} = 15\text{ mA}$, CW operation, Test Circuit B, unless otherwise specified.

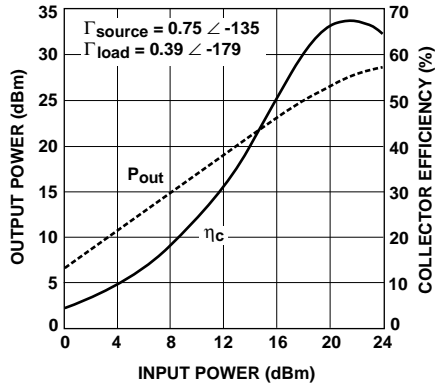

Figure 12. Output Power and Collector Efficiency vs. Input Power.

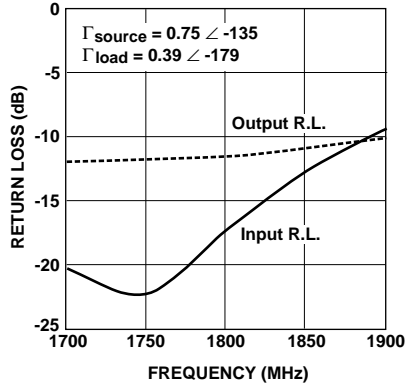

Figure 13. Input and Output Return Loss vs. Frequency.

AT-31625 Typical Large Signal Impedances

$V_{CE} = 4.8\text{ V}$, $I_{CQ} = 15\text{ mA}$, $P_{out} = +25.0\text{ dBm}$

Freq. MHz	Γ_{source}		Γ_{load}	
	Mag.	Ang.	Mag.	Ang.
1700	0.717	-131.8	0.373	-174.3
1725	0.724	-132.6	0.378	-175.6
1750	0.732	-133.4	0.381	-176.7
1775	0.743	-134.3	0.386	-177.9
1800	0.752	-135.4	0.390	-179.1
1825	0.763	-136.3	0.394	179.5
1850	0.773	-137.0	0.397	178.4
1875	0.780	-137.8	0.401	177.1
1900	0.788	-138.7	0.403	175.7

Test Circuit A: Test Circuit Board Layout @ 900 MHz

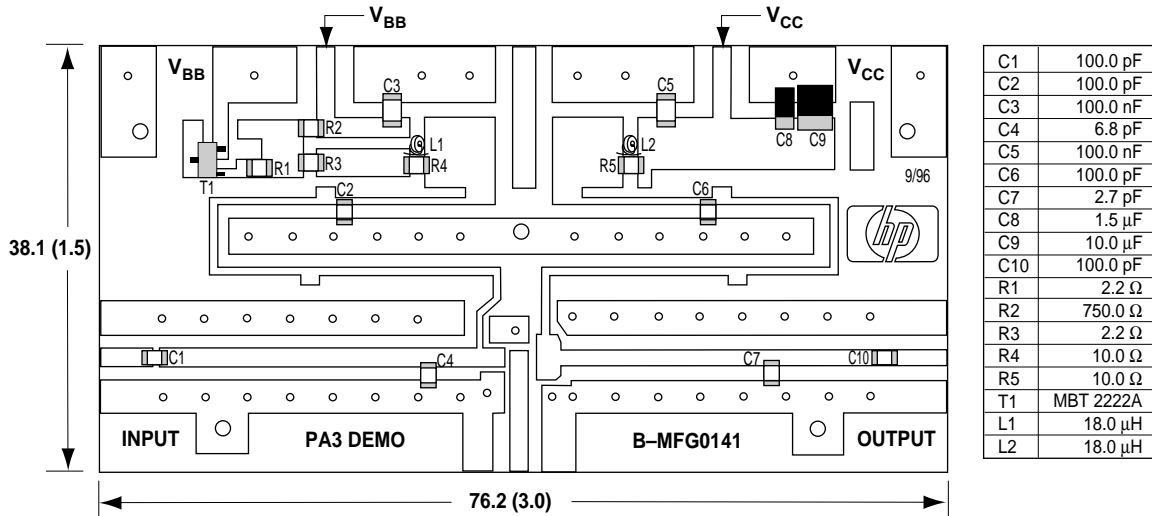

CW Test
 $V_{CE} = 4.8 \text{ V}$
 $I_{CQ} = 5.0 \text{ mA}$
 Freq. = 900 MHz

Test Circuit:
 FR-4 Microstrip, glass epoxy board
 Dielectric Constant = 4.5
 Thickness = 0.79 (.031)

NOTE:
 Dimensions are shown in millimeters (inches).

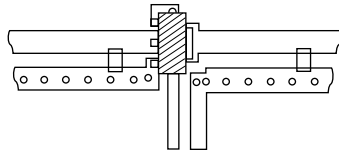

Test Circuit A: Test Circuit Schematic Diagram @ 900 MHz

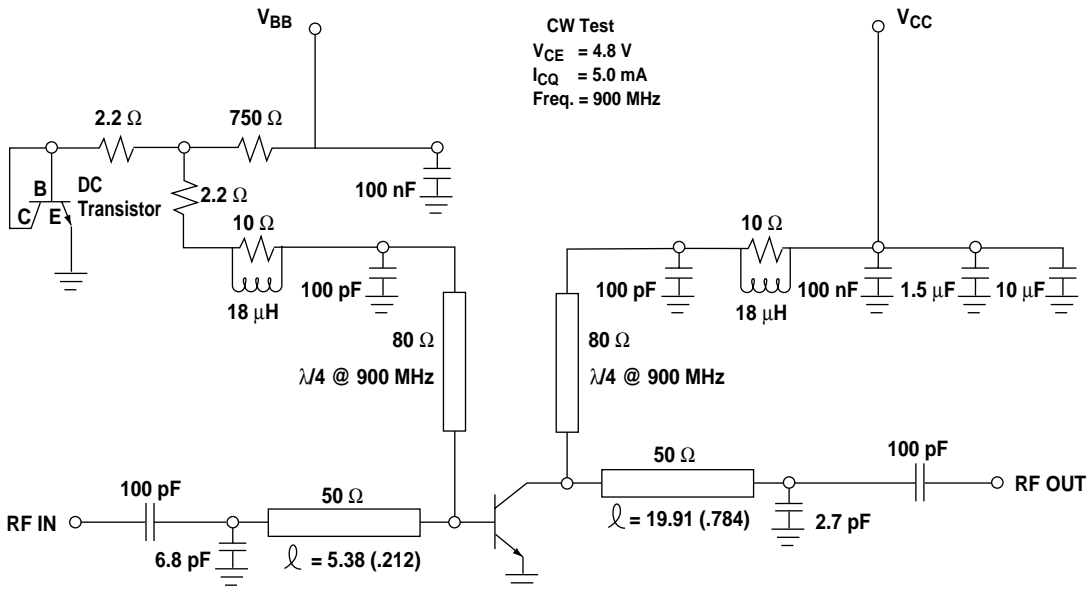

Test Circuit B: Test Circuit Board Layout @ 1800 MHz

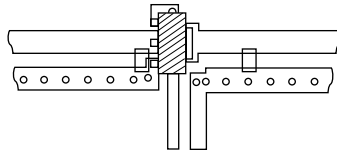
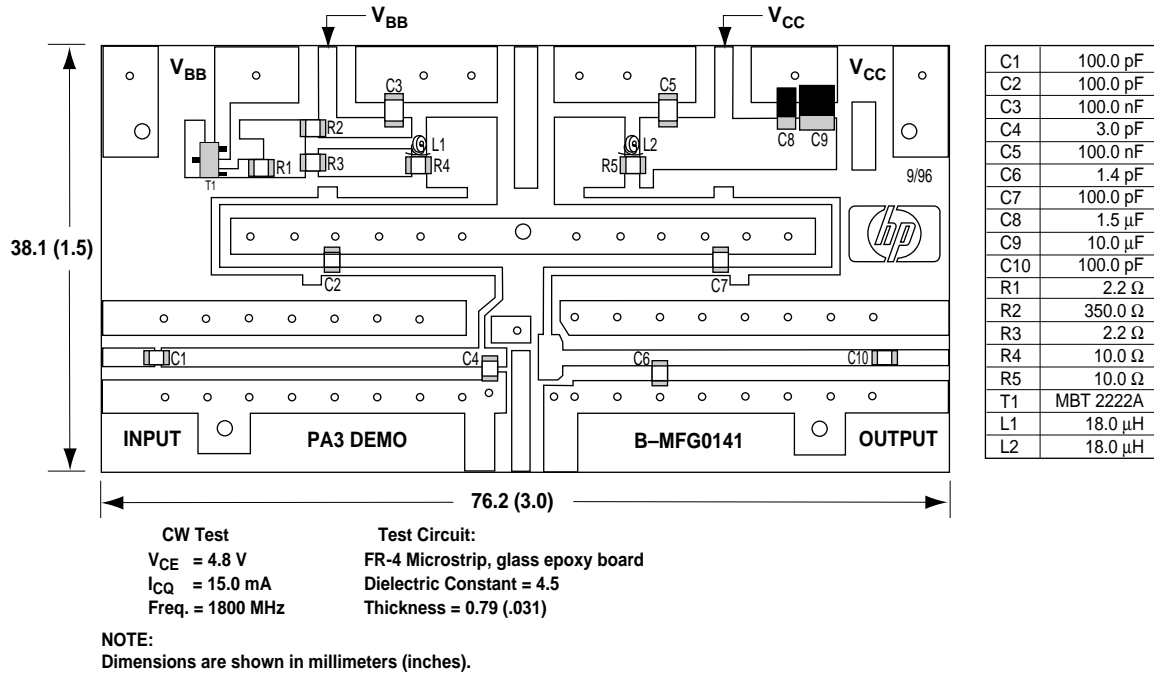

Test Circuit B: Test Circuit Schematic Diagram @ 1800 MHz

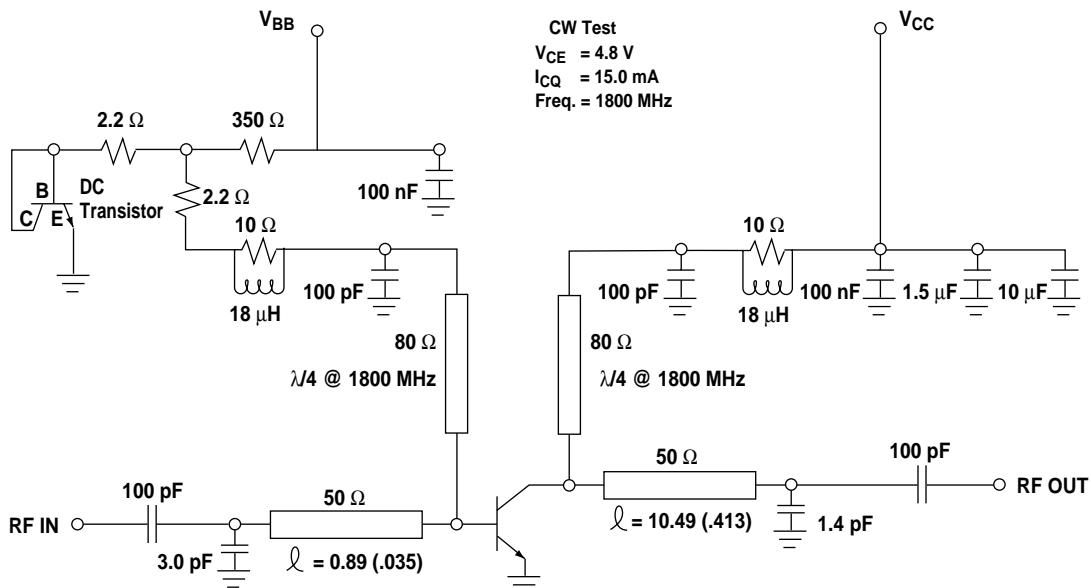

Part Number Ordering Information

Part Number	No. of Devices	Container
AT-31625-TR1	1000	7" Reel
AT-31625-BLK	25	Carrier Tape

Package Dimensions

MSOP-3 Surface Mount Plastic Package

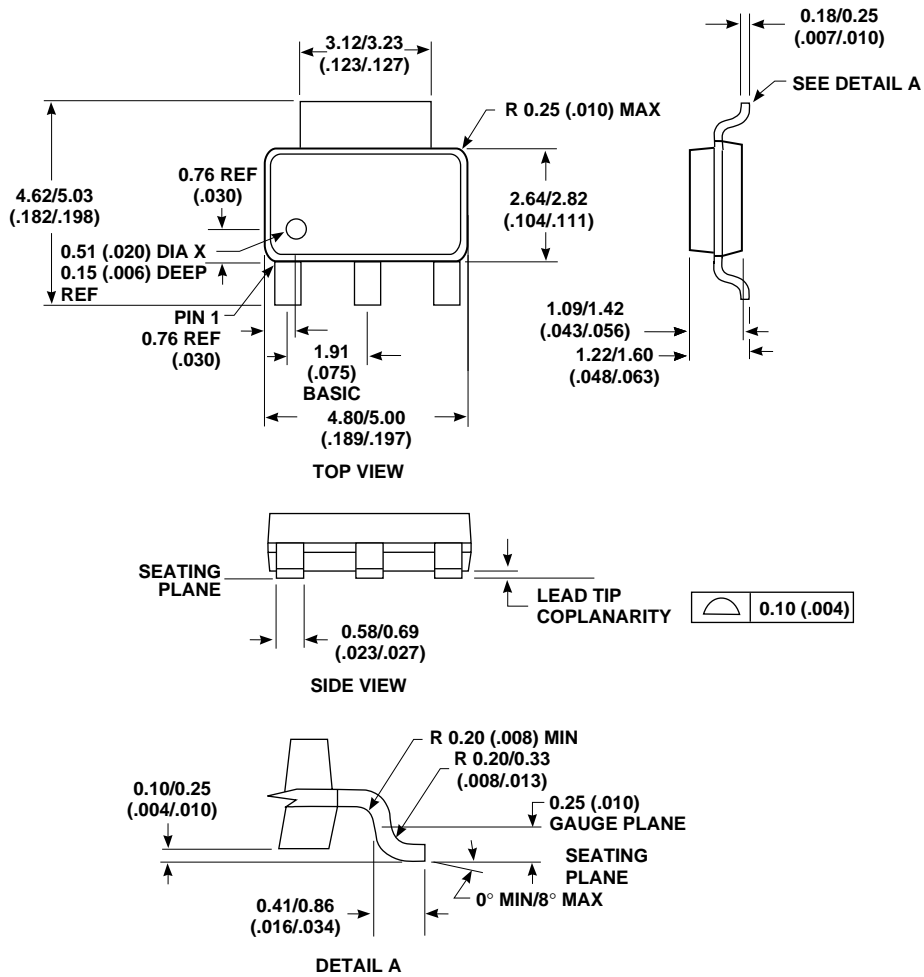

NOTE:
DIMENSIONS ARE SHOWN IN MILLIMETERS (INCHES)

Tape Dimensions and Product Orientation for Package MSOP-3

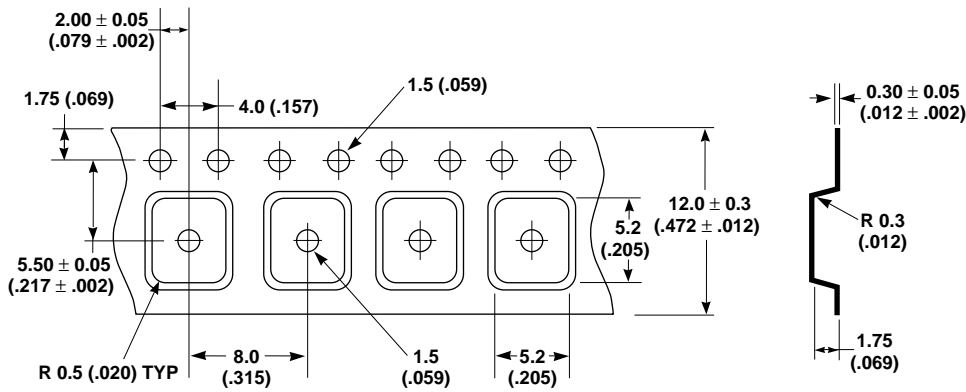
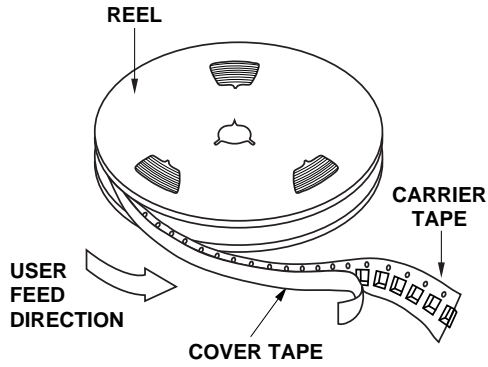

- NOTES:
 1. DIMENSIONS ARE SHOWN IN MILLIMETERS (INCHES)
 2. TOLERANCES: .X \pm 0.1 (.XXX \pm .004)