

3.3V 1A Low Dropout Regulator

Features

- Dropout voltage typically 0.8V @ $I_o = 1A$
- Output current in excess of 1A
- Output voltage accuracy $\pm 2\%$
- Quiescent current, typically 600 μA
- Internal short circuit current limit
- Internal over temperature protection

Applications

- CD-R/W
- ADSL
- Cable Modem
- Set-Top-Box
- LAN switch/Hub
- Router
- DVD-R/W

General Description

The G960 positive 3.3V voltage regulator features the ability to source 1A of output current with a dropout voltage of typically 0.8V over the entire operating temperature range. A low quiescent current is provided over the entire current output current range. The typical quiescent current is 0.6mA. Furthermore, the quiescent current is smaller when the regulator is in the dropout mode ($V_{IN} < 3.3V$).

Familiar regulator features such as over temperature and over current protection circuits are provided to prevent it from being damaged by abnormal operating conditions.

Ordering Information

ORDER NUMBER	PACKAGE TYPE	PIN OPTION		
		1	2	3
G960T33T	TO220	GND	V_{OUT}	V_{IN}
G960T36T	TO220	V_{IN}	V_{OUT}	GND
G960T43U	TO252	GND	V_{OUT}	V_{IN}
G960T45U	TO252	V_{IN}	GND	V_{OUT}
G960T53U	TO263	GND	V_{OUT}	V_{IN}
G960T63U	SOT223	GND	V_{OUT}	V_{IN}

Order Number Identification

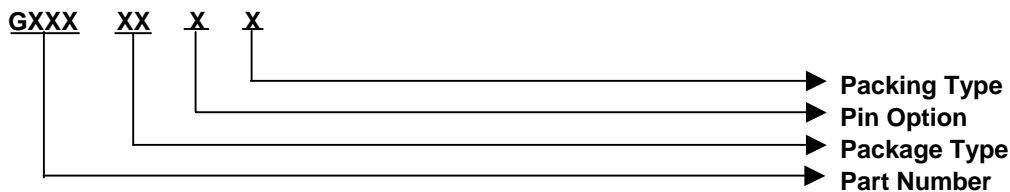

PACKAGE TYPE

- T3 : TO 220
- T4 : TO 252
- T5 : TO 263
- T6 : SOT 223

PIN OPTION

1	2	3
1 : V_{OUT}	GND	V_{IN}
2 : V_{OUT}	V_{IN}	GND
3 : GND	V_{OUT}	V_{IN}
4 : GND	V_{IN}	V_{OUT}
5 : V_{IN}	GND	V_{OUT}
6 : V_{IN}	V_{OUT}	GND

PACKING

- U & D : Tape & Reel Direction
- T : Tube

Typical Application

[Note 4] : Type of C_{OUT}

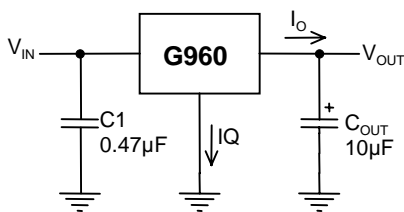

Package Type

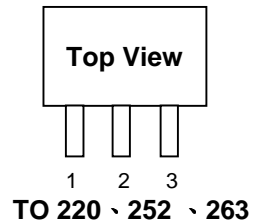
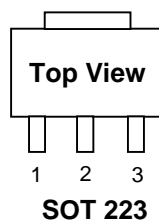

**Absolute Maximum Ratings** (Note 1)

Input Voltage.....	10V
Power Dissipation Internally Limited	(Note 2)
Maximum Junction Temperature.....	150°C
Storage Temperature Range.....	-65°C ≤ T _J ≤ +150°C
Lead Temperature, Time for Wave Soldering	
TO-220 Package.....	260°C, 10s
TO-252 Package.....	260°C, 4s
SOT-223 Package.....	260°C, 4s

Operating Conditions (Note 1)

Input Voltage.....	4V~7V
Temperature Range.....	-40°C ≤ T _J ≤ 125°C

Electrical Characteristics

V_{IN} = 5V, I_O = 1A, C_{IN} = 1μF, C_{OUT} = 10μF, All specifications apply for T_A = T_J = 25°C. [Note 3]

PARAMETER	CONDITIONS	MIN	TYP	MAX	UNITS
Output Voltage	50mA ≤ I _O < 400mA	3.234	3.3	3.366	V
Line Regulation	4V ≤ V _{IN} < 7V, I _O = 10mA		20	50	mV
Load Regulation	50mA ≤ I _O ≤ 1A		30	80	mV
Output Impedance	100mA DC and 20mA AC, f _o = 120Hz		100		mΩ
Quiescent Current	V _{IN} = 5V		0.6		mA
Ripple Rejection	f _i = 120Hz, 1V _{P-P} , I _O = 100mA		42		dB
Dropout Voltage	I _O = 1A		0.8		V
	I _O = 100mA		200		mV
Short Circuit Current		1.6	1.9		A
Over Temperature			125		°C

Note 1: Absolute Maximum Ratings are limits beyond which damage to the device may occur. Operating Conditions are conditions under which the device functions but the specifications might not be guaranteed. For guaranteed specifications and test conditions see the Electrical Characteristics.

Note2: The maximum allowable power dissipation is a function of the maximum junction temperature, T_J, the junction-to-ambient thermal resistance, R_{θJA}, and the ambient temperature, T_A. Exceeding the maximum allowable power dissipation will cause excessive die temperature, and the regulator will go into thermal shut-down.

Note3: Low duty pulse techniques are used during test to maintain junction temperature as close to ambient as possible.

Note4: The type of output capacitor should be tantalum or aluminum.

Definitions**Dropout Voltage**

The input/output Voltage differential at which the regulator output no longer maintains regulation against further reductions in input voltage. Measured when the output drops 100mV below its nominal value, dropout voltage is affected by junction temperature, load current and minimum input supply requirements.

Line Regulation

The change in output voltage for a change in input voltage. The measurement is made under conditions of low dissipation or by using pulse techniques such that average chip temperature is not significantly affected.

Load Regulation

The change in output voltage for a change in load current at constant chip temperature. The measurement is made under conditions of low dissipation or by using pulse techniques such that average chip temperature is not significantly affected.

Maximum Power Dissipation

The maximum total device dissipation for which the regulator will operate within specifications.

Quiescent Bias Current

Current which is used to operate the regulator chip and is not delivered to the load.



Typical Performance Characteristics

($V_{IN}=5V$, $C_{IN}=1\mu F$, $C_{OUT}=10\mu F$, $T_A=25^\circ C$, unless otherwise noted.)

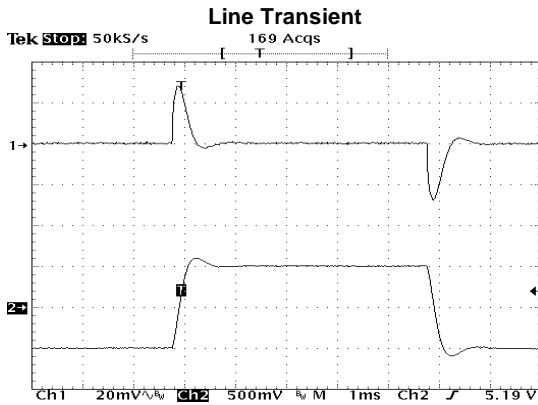

Ch1: Vout (offset=3.30V)
Ch2: Vin (offset=5.0V)
 $C_{IN} = 2.2\mu F$
 $I_{out}=100mA$

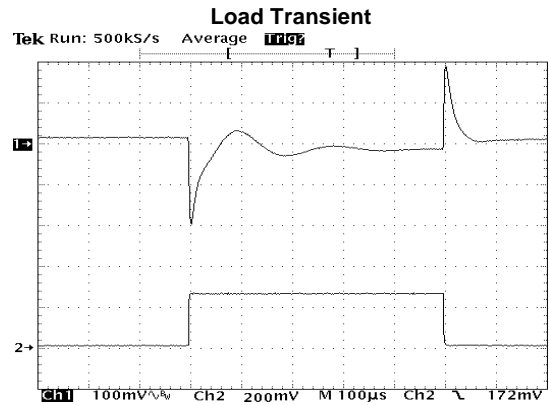

Ch1: Vout (offset=3.30V)
Ch2: Iout (780mA/div)

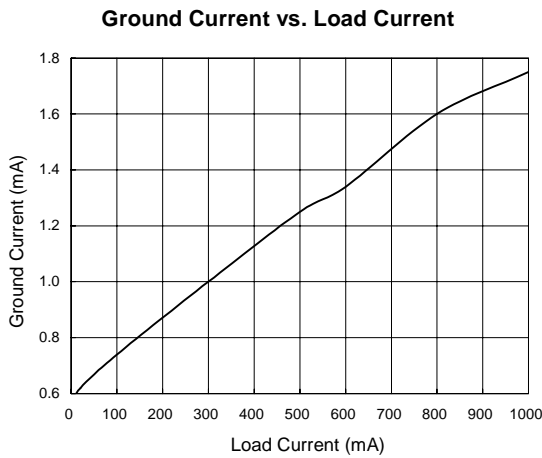
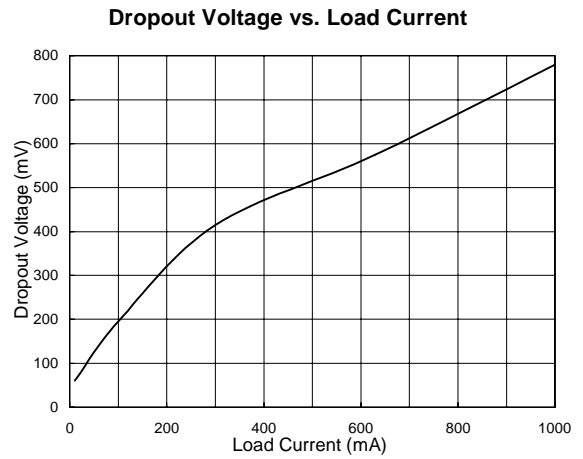
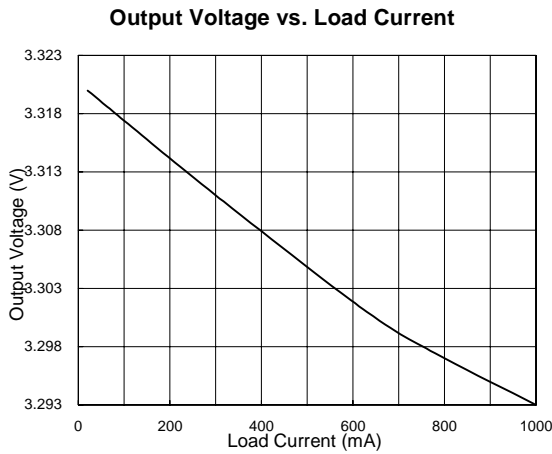

Package Information

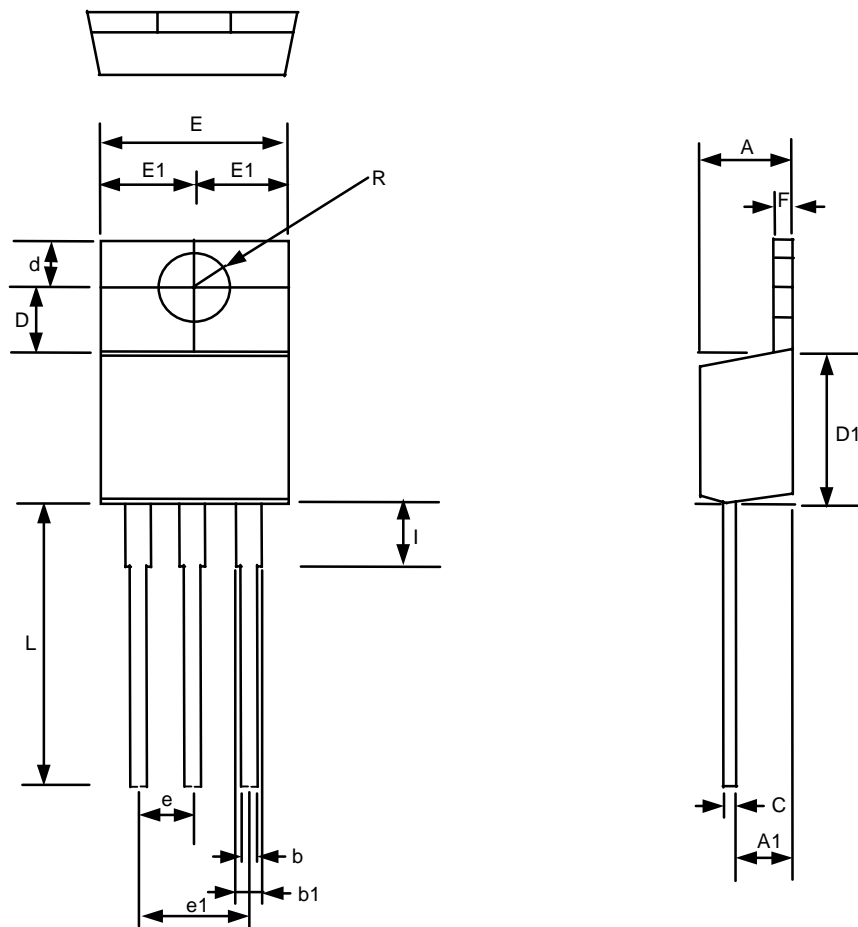

TO-220 (T3) Package

SYMBOLS	MILLIMETERS		INCHES	
	MIN	MAX	MIN	MAX
A	4.318	4.826	0.170	0.190
A1	2.46	2.72	0.097	0.107
b	0.69	0.94	0.027	0.037
b1	1.143	1.397	0.045	0.055
C	0.304	0.460	0.012	0.018
D	3.429	3.683	0.135	0.145
D1	8.53	9.04	0.336	0.356
d	2.62	2.87	0.103	0.113
E	9.906	10.40	0.390	0.410
E1	2.84	5.13	0.112	0.202
e	2.29	2.79	0.090	0.110
e1	4.83	5.33	0.190	0.210
F	1.143	1.397	0.045	0.055
I	3.454	3.962	0.136	0.156
L	13.589	14.351	0.535	0.565

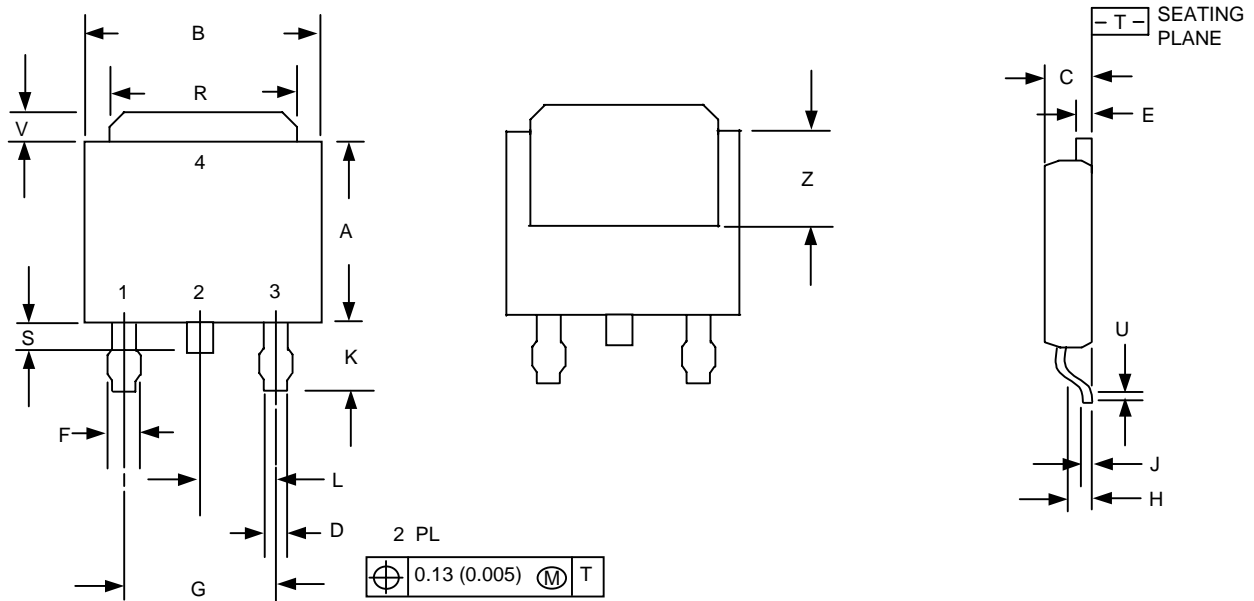

TO-252 (T4) Package

Notes:

1. Dimensioning and tolerancing per ansi y14.5m, 1982.
2. Controlling dimension: inch

SYMBOLS	MILLIMETERS		INCHES	
	MIN	MIN	MAX	MAX
A	5.97	0.235	0.250	6.35
B	6.35	0.250	0.265	6.73
C	2.19	0.086	0.094	2.38
D	0.69	0.027	0.035	0.88
E	0.84	0.033	0.040	1.01
F	0.94	0.037	0.047	1.19
G	4.58BSC		0.180BSC	
H	0.87	0.034	0.040	1.01
J	0.46	0.018	0.023	0.58
K	2.60	0.102	0.114	2.89
L	2.29BSC		0.090BSC	
R	4.45	0.175	0.215	6.46
S	0.51	0.020	0.050	1.27
U	0.51	0.020	---	---
V	0.77	0.030	0.050	1.27
Z	3.51	0.138	---	---

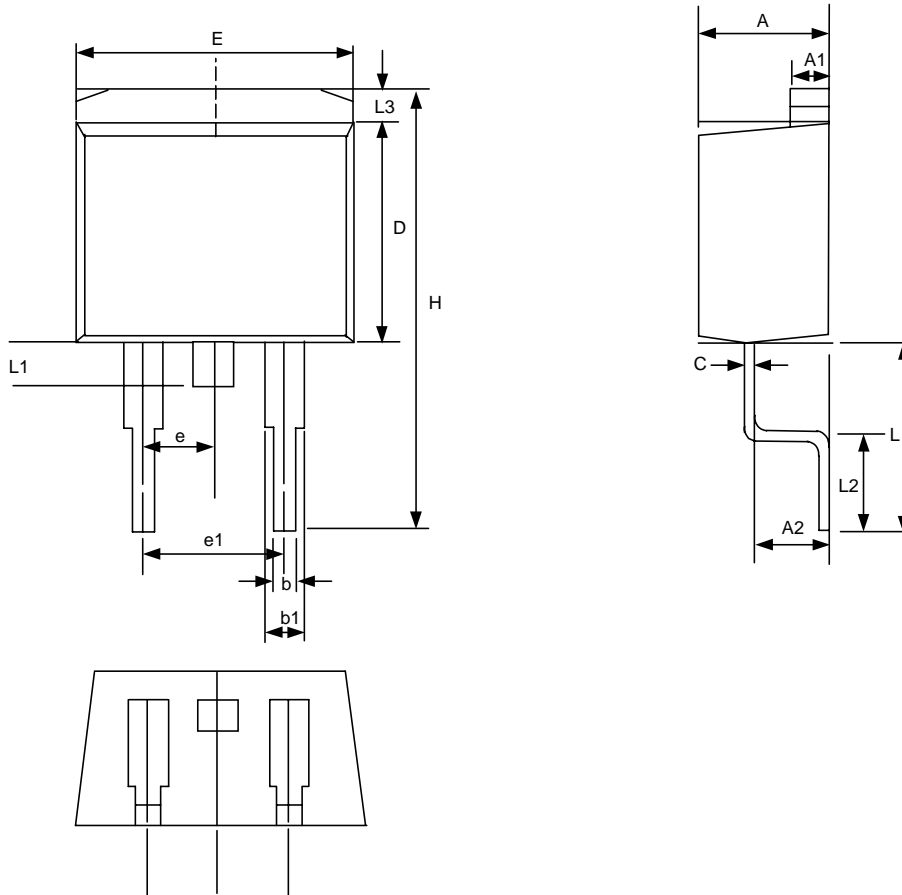

TO-263 (T5) Package

SYMBOLS	MILLIMETERS		INCHES	
	MIN	MAX	MIN	MAX
A	4.30	4.70	0.169	0.185
A1	1.22	1.32	0.048	0.055
A2	2.45	2.69	0.104	0.106
b	0.69	0.94	0.027	0.037
b1	1.22	1.40	0.048	0.055
C	0.36	0.56	0.014	0.022
D	8.64	9.652	0.340	0.380
E	9.70	10.54	0.382	0.415
e	2.29	2.79	0.090	0.110
e1	4.83	5.33	0.190	0.210
H	14.60	15.78	0.575	0.625
L	4.70	5.84	0.185	0.230
L1	1.20	1.778	0.047	0.070
L2	2.24	2.84	0.088	0.111
L3	1.40MAX		0.055MAX	

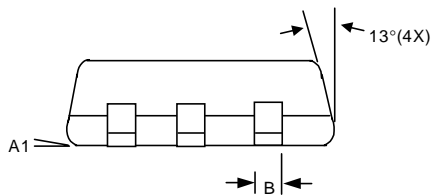
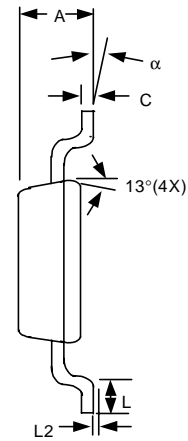
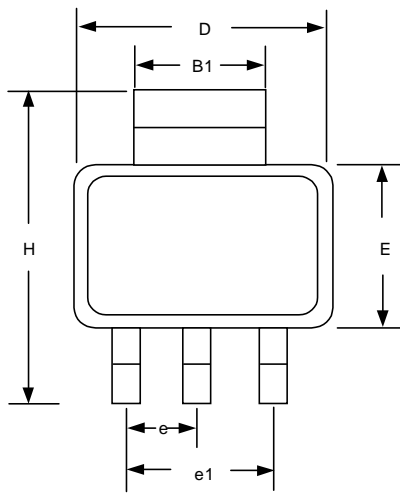

SOT-223 (T6) Package

SYMBOLS	MILLIMETERS		INCHES	
	MIN	MAX	MIN	MAX
A	1.55	1.80	0.061	0.071
A1	0.02	0.12	0.0008	0.0047
B	0.60	0.80	0.024	0.031
B1	2.90	3.10	0.114	0.122
C	0.24	0.32	0.009	0.013
D	6.30	6.70	0.248	0.264
E	3.30	3.70	0.130	0.146
e	2.30 BSC		0.090 BSC	
e1	4.60 BSC		0.181 BSC	
H	6.70	7.30	0.264	0.287
L	0.90 MIN		0.036 MIN	
L2	0.06 BSC		0.0024 BSC	
α	0°	10°	0°	10°

Package Orientation

