

General Description

The AAT1235 is a highly integrated, high efficiency power solution for white LED backlight and keypad backlights in mobile/portable devices. It is based on a switching boost converter which steps up the single-cell lithium-ion/polymer battery voltage to drive 5 strings of series-connected white LEDs with precision current regulation. The AAT1235 is capable of driving a total of four LEDs per channel.

The boost converter can produce an output drive of up to 24V at 100mA. The high switching frequency (up to 2MHz) provides fast response to load transients and allows the use of small external components. A fully integrated control circuit simplifies the design and reduces total solution size.

AnalogicTech's Advanced Simple Serial Control™ (AS²Cwire™) serial digital input is used to individually turn each output sink on/off and adjust the LED current by group. Unlike conventional pulse width modulation (PWM) control of LED brightness, the AAT1235 drives the LEDs with constant, non-pulsating current.

A similar device is also available with an I²C two-wire interface; please see the AAT1236 datasheet.

The AAT1235 is available in a Pb-free, thermally-enhanced 16-pin 3x4mm TDFN package and is specified for operation over the -40°C to +85°C temperature range.

Features

- Input Supply Voltage Range: 2.7V to 5.5V
- Maximum Boost Output Drive: Up to 24V at 100mA
- Up to 85% Efficient Operation
- Up to 2MHz Switching Frequency with Small Inductor
- User-Programmable Full-Scale LED Current, Up to 30mA
- Single-Wire AS²Cwire Serial Interface
 - Five Addressable Registers
 - Independent LED Current Control by Group
 - Backlight Group B1-B2, 16 Settings
 - Auxiliary Group A1-A3, 16 Settings
 - Independent LED ON/OFF Control
 - Fast, 1MHz Serial Interface
- Non-Pulsating, High-Performance LED Current Drive for Uniform Illumination
 - 10% Absolute Accuracy
 - 2% Channel-to-Channel Matching
- Over-Voltage and Over-Temperature Protection
- Automatic Soft-Start Minimizes Large Inrush Current at Startup
- Available in 3x4mm TDFN34-16 Package

Applications

- Digital Still Cameras (DSCs)
- Keypad Backlight
- Large Panel Displays
- Mobile Handsets
- Personal Media Players
- PDAs and Notebook PCs
- White LED Backlight

Typical Application

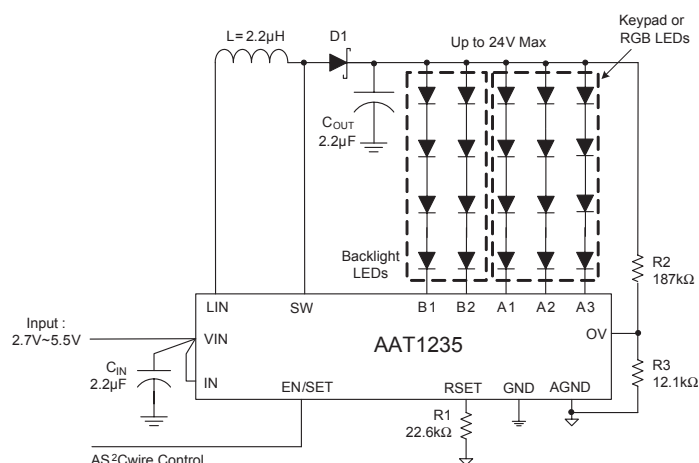

Pin Descriptions

Pin #	Symbol	Function
1	VIN	Input supply for the converter. Connect a 2.2μF or larger ceramic capacitor from VIN to GND.
2	OV	Boost output over voltage detect pin. Use resistor divider to set the circuit's external over-voltage protection. See Applications Information for details.
3	EN/SET	AS ² Cwire control or enable pin.
4	B1	Backlight current sink 1. Connect the cathode of the last LED in the string to B1.
5	B2	Backlight current sink 2. Connect the cathode of the last LED in the string to B2.
6	RSET	LED current set resistor. A 22.6kΩ resistor from RSET to AGND sets the maximum LED current in A1-A3 and B1-B2 to 20mA.
7	IN	Input bias supply for the internal circuitry. Connect IN to VIN directly at the AAT1235.
8	GND	Ground for the boost converter. Connect GND to AGND at a single point as close to the AAT1235 as practical.
9	SW	Boost converter switching node. A 2.2μH inductor, connected between SW and LIN, sets the boost converter's switching frequency.
10, 11	N/C	Not connected.
12	AGND	Ground pin. Connect AGND to GND at a single point as close to the AAT1235 as practical.
13	A3	Auxiliary current sink 3. Connect the cathode of the last LED in the string to A3.
14	A2	Auxiliary current sink 2. Connect the cathode of the last LED in the string to A2.
15	A1	Auxiliary current sink 1. Connect the cathode of the last LED in the string to A1.
16	LIN	Switched power input. Connect LIN to the external power inductor.
EP		Exposed paddle (bottom) Connected internally to SW. Connect to SW or leave floating.

Pin Configuration

**TDFN34-16
(Top View)**

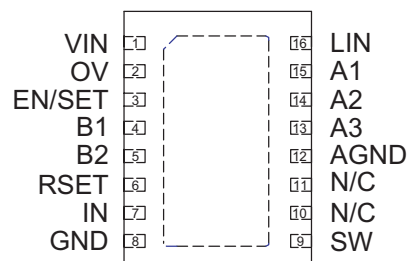

Absolute Maximum Ratings¹

$T_A = 25^\circ\text{C}$ unless otherwise noted.

Symbol	Description	Value	Units
V _{IN} , I _N	Input Voltage	-0.3 to 6.0	V
SW	Switching Node	28	V
EN/SET, Bx, Ax, RSET, OV, LIN	Maximum Rating	V _{IN} + 0.3	V
T _S	Storage Temperature Range	-65 to 150	°C
T _J	Operating Temperature Range	-40 to 150	°C
T _{LEAD}	Maximum Soldering Temperature (at leads, 10 sec)	300	°C

Thermal Information²

Symbol	Description	Value	Units
θ_{JA}	Thermal Resistance	50	°C/W
P _D	Maximum Power Dissipation ³	2	W

1. Stresses above those listed in Absolute Maximum Ratings may cause permanent damage to the device. Functional operation at conditions other than the operating conditions specified is not implied. Only one Absolute Maximum Rating should be applied at any one time.
2. Mounted on an FR4 circuit board.
3. Derate 20mW/°C above 40°C ambient temperature.

Electrical Characteristics¹

$V_{IN} = 3.6V$; $C_{IN} = 2.2\mu F$; $T_A = -40^\circ C$ to $+85^\circ C$, unless otherwise noted. Typical values are at $T_A = 25^\circ C$.

Symbol	Description	Conditions	Min	Typ	Max	Units
Power Supply						
V_{IN}	Input Voltage Range		2.7		5.5	V
$V_{OUT(MAX)}$	Maximum Output Voltage				24	V
V_{UVLO}	UVLO Threshold	V_{IN} Rising			2.7	V
		Hysteresis		150		mV
		V_{IN} Falling	1.8			V
I_{CC}	Operating Current (No Switching)	$B1 = B2 = A1 = A2 = A3 = 1.2V$, 2mA Setting, $R_{SET} = 226k\Omega$			300	μA
$I_{SHDN(MAX)}$	IN Pin Shutdown Current	EN = GND			1.0	μA
I_{OX}	Maximum Continuous Output Current	$V_O = 24V$	100			mA
I_{DX}	Current Sink Accuracy	$R_{SET} = 22.6k\Omega$	18	20	22	mA
$I_{DX-Matching}$	Current Matching Between Any Sink Channels	$R_{SET} = 22.6k\Omega$, $A1 = A2 = A3 = B1 = B2 = 0.4V$		2	5	%
T_{SS}	Soft-Start Time	From Enable to Output Regulation; $V_{FB} = 300mV$		300		μs
V_{OV}	OVP Threshold Voltage	V_{OUT} Rising	1.1	1.2	1.3	V
	OVP Threshold Hysteresis			100		mV
$R_{DS(ON)IN}$	Low Side Switch On Resistance	$I_{OUT} = 100mA$		80		$m\Omega$
$R_{DS(ON)IN}$	Input Disconnect Switch	$I_{OUT} = 100mA$		200		$m\Omega$
I_{SET}	Current Set Ratio	I_{SINK}/I_{RSET} , $V_{RSET} = 0.6V$		760		A/A
I_{LIMIT}	Input Switch Current Limit		1.2			A
EN/SET Input						
$V_{EN(L)}$	Enable Threshold Low				0.4	V
$V_{EN(H)}$	Enable Threshold High		1.4			V
$T_{EN/SET LO}$	EN/SET Low Time		0.3		75	μs
$T_{EN/SET HI}$	EN/SET High Time				75	μs
T_{OFF}	EN/SET Off Timeout				500	μs
T_{LAT}	EN/SET Latch Timeout				500	μs
$I_{EN/SET}$	EN/SET Input Leakage	$V_{EN/SET} = V_{IN} = 5V$	-1		1	μA
Thermal Protection						
T_{J-TH}	T_J Thermal Shutdown Threshold			140		$^\circ C$
T_{J-HYS}	T_J Thermal Shutdown Hysteresis			15		$^\circ C$

1. The AAT1235 is guaranteed to meet performance specifications over the $-40^\circ C$ to $+85^\circ C$ operating temperature range is assured by design, characterization, and correlation with statistical process controls.

Typical Characteristics

Efficiency vs. LED Current
(Group B On; Group A Off)

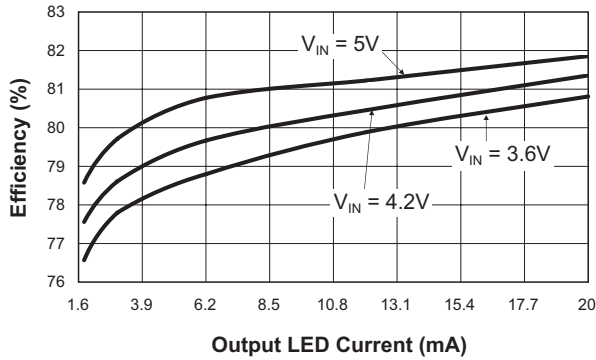

Efficiency vs. LED Current
(Group B Off; Group A On)

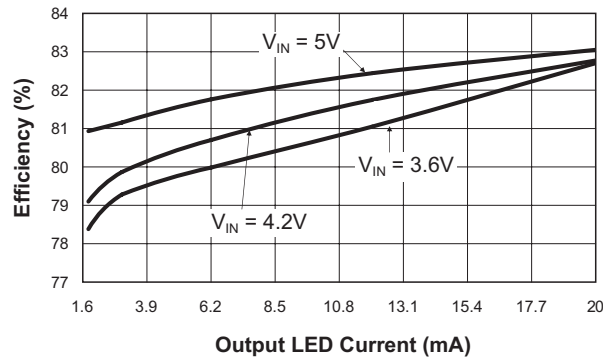

Efficiency vs. LED Current
(Group A and B On)

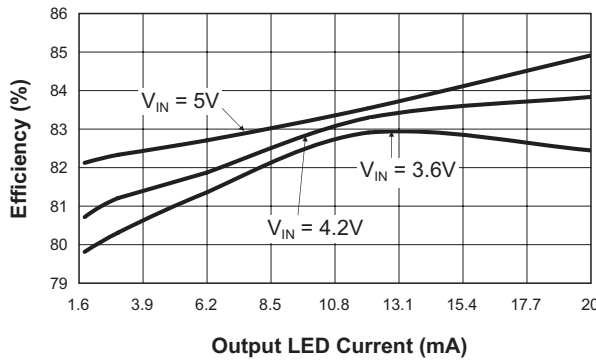

LED Current Accuracy vs. Supply Voltage

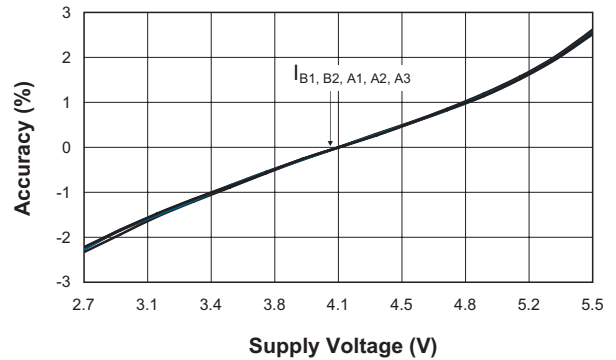

LED Current vs. Supply Voltage

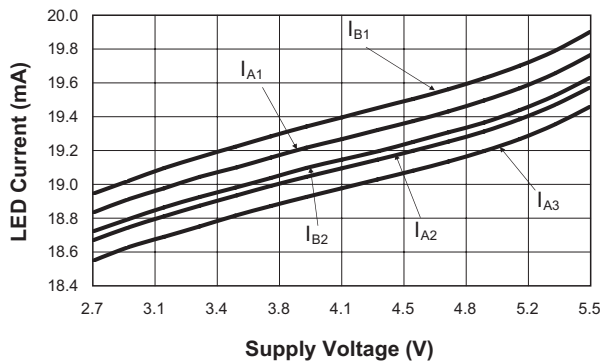

Shutdown Current vs. Supply Voltage and Temperature

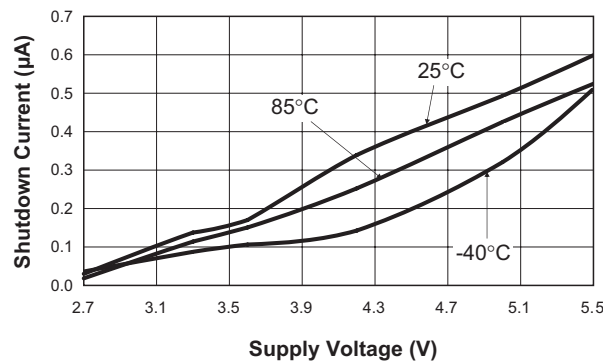

Typical Characteristics

LED Current vs. Temperature
(All Channels = 20mA)

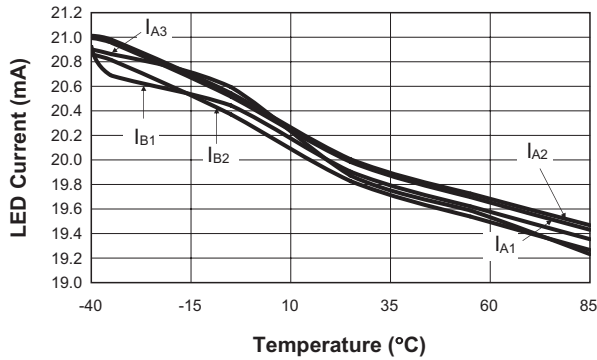

LED Current Accuracy vs. Temperature
(All Channels = 20mA)

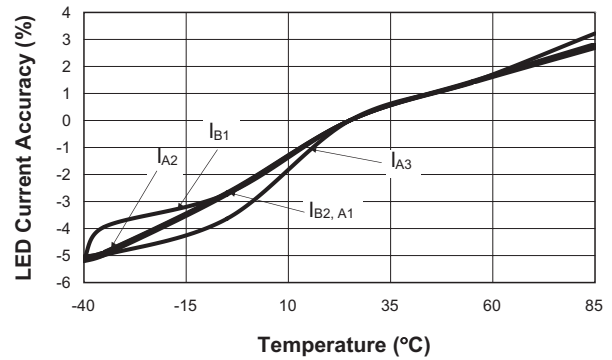

Shutdown Operation
(All Channels)

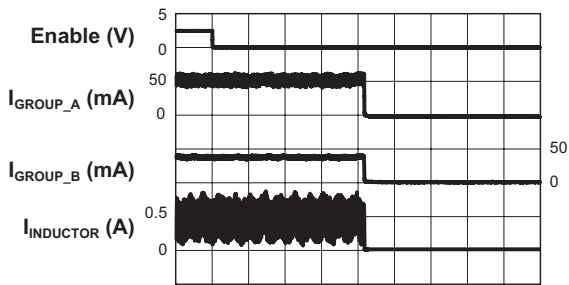

Time (50µs/div)

Output Ripple
(All Channels = 20mA)

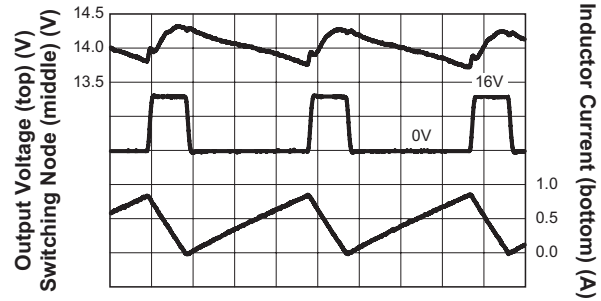

Time (200ns/div)

Output Ripple
(All Channels = 10mA)

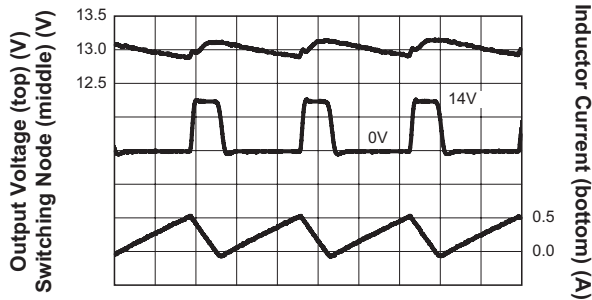

Time (200ns/div)

Switching Frequency vs. Supply Voltage and Temperature

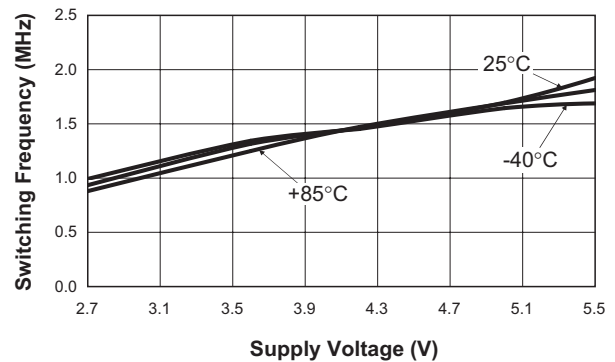

Typical Characteristics

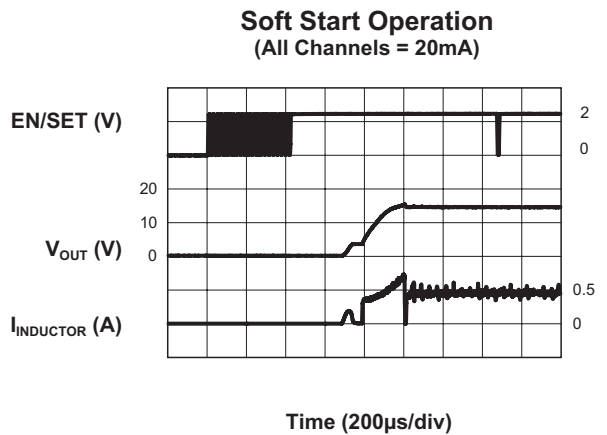
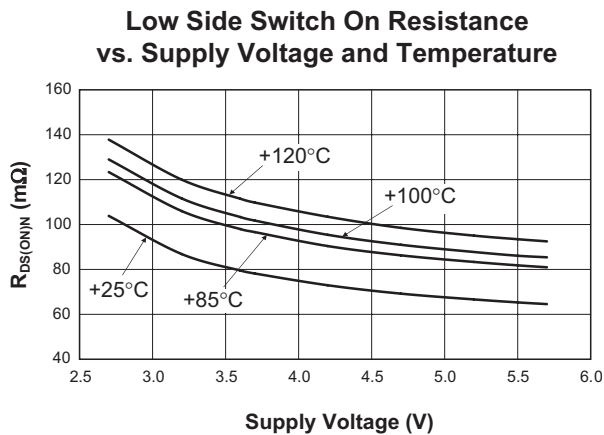
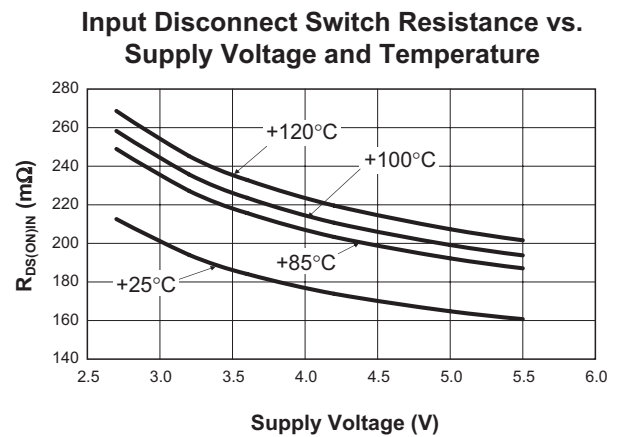
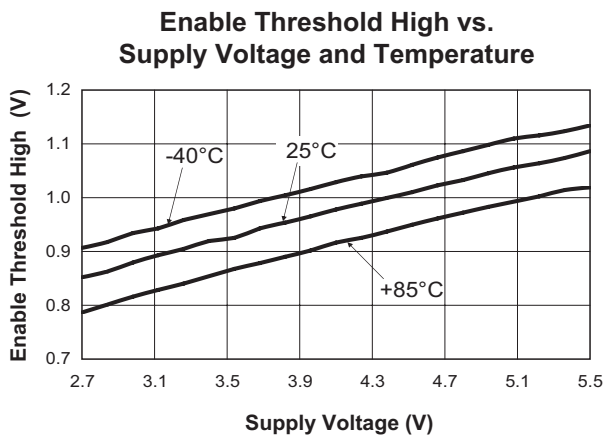
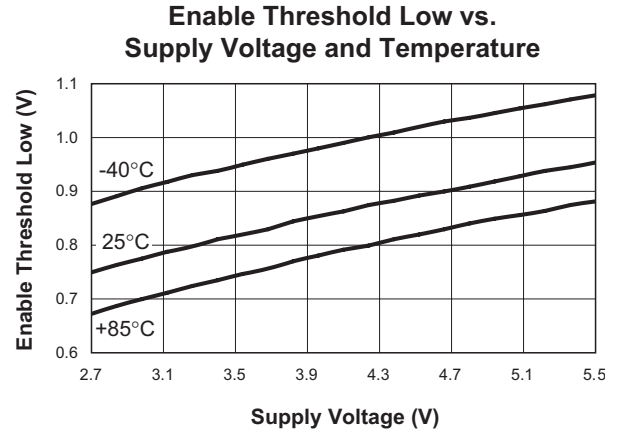
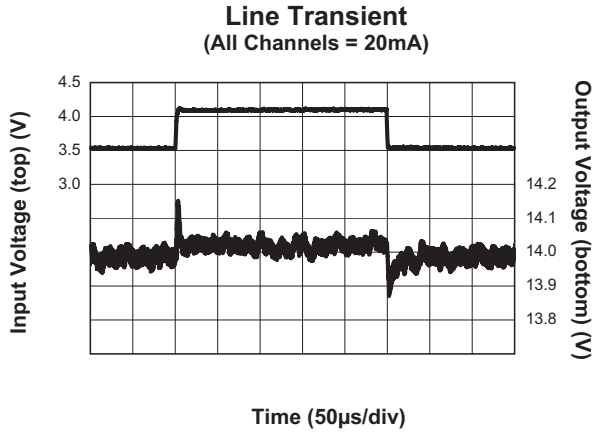

Typical Characteristics

**EN/SET Off Timeout vs.
Supply Voltage and Temperature**

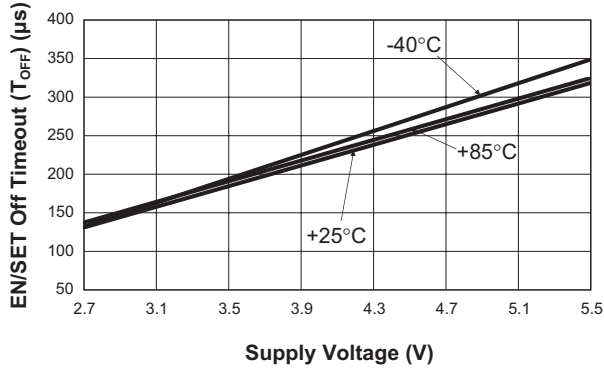

**EN/SET Latch Timeout vs.
Supply Voltage and Temperature**

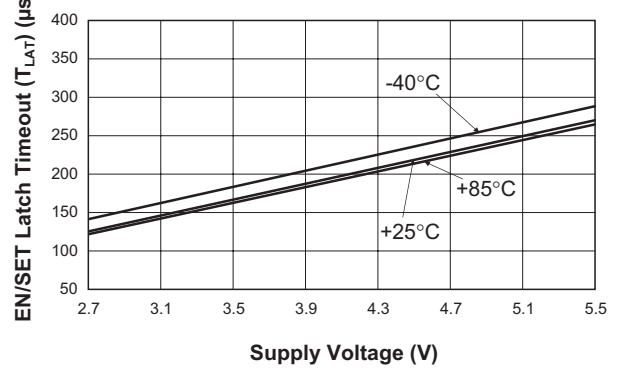

**Transition of LED Current
(Group B = 1.8mA; Group A = 20mA to 1.8mA)**

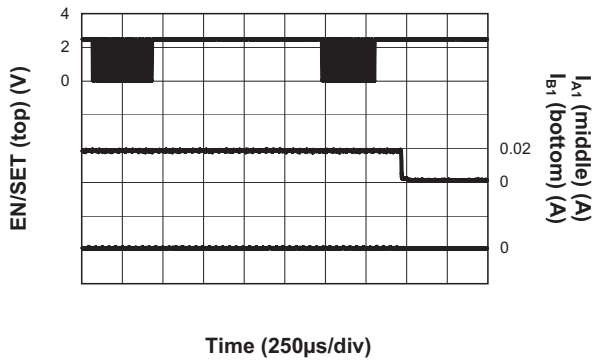

**Transition of LED Current
(Group B = 1.8mA to 20mA; Group A = 20mA)**

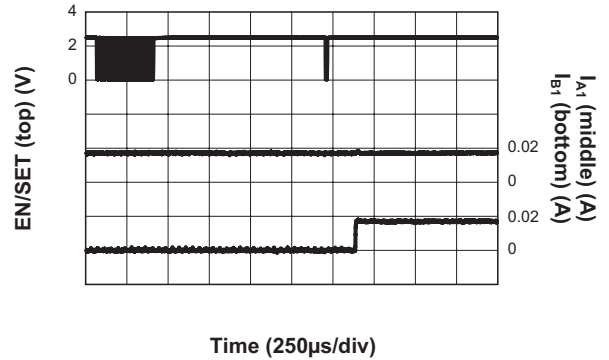

**Transition of LED Current
(Group B = 20mA; Group A = 20mA to 1.8mA)**

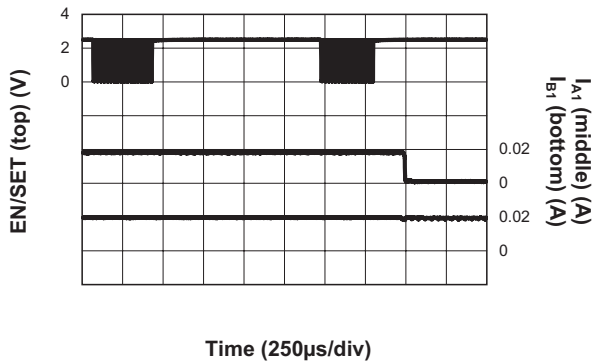

Functional Block Diagram

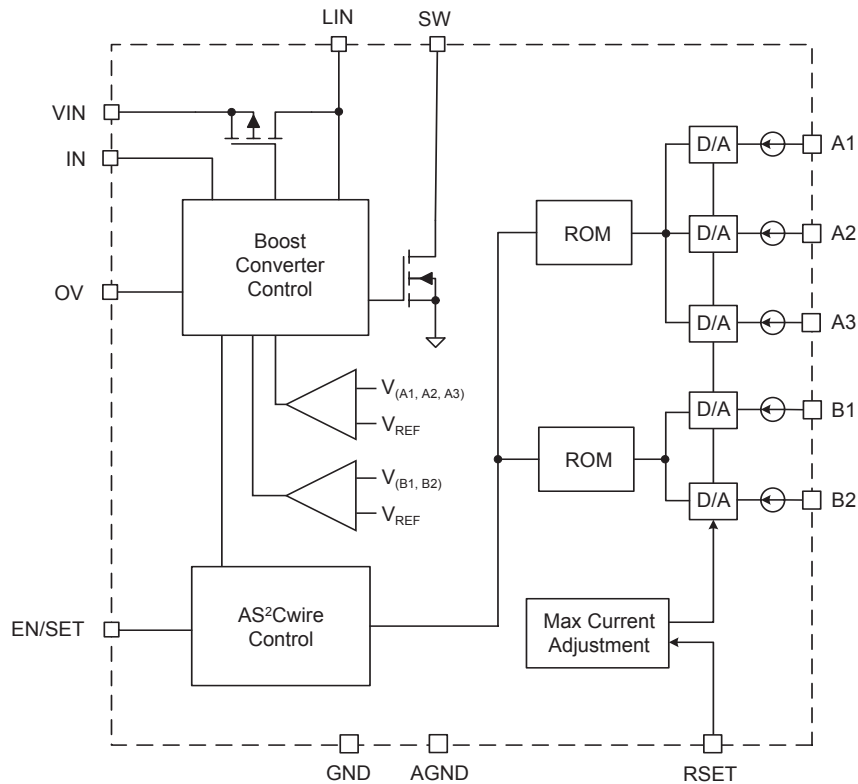

Functional Description

The AAT1235 consists of a controller for the step-up switching converter and its power switch, and five regulated current sinks each programmable at 16 levels into two groups, which can be turned on/off individually. An external Schottky diode, a power inductor, an output capacitor, and a resistor divider are required to complete the solution.

The AAT1235's boost controller is designed to deliver 100mA up to 24V. The AAT1236 is capable of driving a total of five channels divided into two groups with four white LEDs connected in series at each channel.

The output load current can be programmed by the current sink magnitudes. AS²Cwire programming allows independent control of two current sink groups (A1 to A3 and B1 to B2) and control on/off

with a different configuration on each channel. Unused sink channel(s) must be connected to AGND to ensure proper function of the AAT1235.

Control Loop

The AAT1235 provides the benefits of current mode control with a simple hysteretic output current loop providing exceptional stability and fast response with minimal design effort. The device maintains exceptional constant current regulation, transient response, and cycle-by-cycle current limit without additional compensation components.

The AAT1235 modulates the power MOSFET switching current to maintain the programmed sink current through each channel. The sink voltage at each channel is monitored and the controller provides direct feedback in order to maintain the desired LED current.

The switching cycle initiates when the N-channel MOSFET is turned ON and current ramps up in the inductor. The ON interval is terminated when the inductor current reaches the programmed peak current level. During the OFF interval, the input current decays until the lower threshold, or zero inductor current, is reached. The lower current is equal to the peak current minus a preset hysteresis threshold, which determines the inductor ripple current. Peak current is adjusted by the controller until the desired LED output current level is met.

The magnitude of the feedback error signal determines the average input current. Therefore, the AAT1235 controller implements a programmed current source connected to the output capacitor, parallel with the LED channels. There is no right-half plane zero, and loop stability is achieved with no additional compensation components. The controller responds by increasing the peak inductor current, resulting in higher average current in the inductor and LED channels.

Under light load conditions, the inductor OFF interval current goes below zero and the boost converter enters discontinuous mode operation. Further reduction in the load current results in a corresponding reduction in the switching frequency. The AAT1235 provides a pulsed frequency operation which reduces switching losses and maintains high efficiency under light load conditions.

Operating frequency varies with changes in the input voltage, output voltage, and inductor size. Once the boost converter has reached continuous mode, further increases in the LED current will not significantly change the operating frequency. A small 2.2 μ H ($\pm 20\%$) inductor is selected to maintain high frequency switching (up to 2MHz) and high efficiency operation for outputs up to 24V.

Soft Start / Enable

The input disconnect switch is activated when a valid supply voltage is present and the EN/SET pin is strobed high. Slew rate control on the input disconnect switch ensures minimal inrush current as

the output voltage is charged to the input voltage, prior to switching of the N-channel power MOSFET. A monotonic turn-on is guaranteed by the built-in soft-start circuitry, which eliminates output current overshoot across the full input voltage range and all load conditions.

Current Limit and Over-Temperature Protection

The switching of the N-channel MOSFET terminates when a current limit of 1.5A (typical) is exceeded. This minimizes power dissipation and component stresses under overload and short-circuit conditions. Switching resumes when the current decays below the current limit.

Thermal protection disables the AAT1235 when internal power dissipation becomes excessive, as it disables both MOSFETs. The junction over-temperature threshold is 140°C with 15°C of temperature hysteresis. The output voltage automatically recovers when the over-temperature fault condition is removed.

Over-Voltage Protection

Over-voltage protection prevents damage to the AAT1235 during open-circuit causing high output voltage conditions. An over-voltage event is defined as a condition where the voltage on the OV pin exceeds the over-voltage threshold limit ($V_{OV} = 1.2V$ typical). When the voltage on the OV pin has reached the threshold limit, the converter stops switching and the output voltage decays. Switching resumes when the voltage on the OV pin drops below the lower hysteresis limit, maintaining an average output voltage between the upper and lower OV thresholds multiplied by the resistor divider scaling factor.

Under-Voltage Lockout

Internal bias of all circuits is controlled via the VIN input. Under-voltage lockout (UVLO) guarantees sufficient V_{IN} bias and proper operation of all internal circuitry prior to soft start.

Constant Current Output Level Settings and AS²Cwire Serial Interface

The LED current sink level of each group and the on/off status of each channel is controlled by AnalogicTech's AS²Cwire serial digital input. Since each current sink is programmable, no PWM or additional control circuitry is needed to control LED brightness. This feature greatly reduces the burden on a microcontroller or system IC to manage LED or display brightness, allowing the user to "set it and forget it." With its high-speed serial interface (1MHz data rate), the input sink current can be changed quickly and easily. Also the non-pulsating LED current reduces system noise and improves LED reliability.

AS²Cwire relies on the number of rising edges of the EN/SET pin to address and load the registers. AS²Cwire latches data or address after the EN/SET pin has been held high for time T_{LAT} (500 μ s). Address or data is differentiated by the number of EN/SET rising edges. Since the data registers are 4 bits each, the differentiating number of pulses is 2^4 or 16, so that Address 0 is signified by 17 rising edges, Address 1 by 18 rising edges, and so forth. Data is set to any number of rising edges between 1 and including 16. A typical write protocol is a burst of EN/SET rising edges, signifying a particular address, followed by a pause with EN/SET held high for the T_{LAT} timeout period, a burst of rising edges signifying data, and a T_{LAT} timeout for the data registers. Once an address is set, then multiple writes to that address are allowed where only data is issued. When EN/SET is held low for an amount of time longer than T_{OFF} (500 μ s), the AAT1235 enters into shutdown mode and draws less than 1 μ A from the input. Data and Address registers are cleared (reset to 0) during shutdown.

Address	EN/SET Rising Edges	Data Register
0	17	B1-B2 current
1	18	A1-A3 current
2	19	B1-B2 on/off
3	20	A1-A3 on/off
4	21	A1-A3, B1-B2 on

Table 1: AS²Cwire Serial Interface Addressing.

Address 0 and 1: LED Brightness Control

Outputs A1, A2, A3, B1, B2 are each capable of sinking up to 30mA. The maximum current can be programmed by an external resistor at the RSET pin. It is suggested to connect up to four white LEDs in series for each channel and to keep the same number of LEDs in each channel.

Outputs B1 and B2 are intended to drive the white LEDs for the backlight in a phone, while A1:A3 can supply the keypad LEDs. For large displays, all five outputs can be used.

Data	All Outputs (%)
1	100
2	84
3	71
4	60
5	51
6	43
7	35
8	31
9	26
10	21
11	18
12	15
13	13.5
14	12.0
15	10.5
16	9.0

Table 2: Address 0 and 1 for Current Setting as Percentage of the Maximum Level Set by R_{SET}.

Address 2: LED Group B ON/OFF Control

Data	B1	B2
1	Off	Off
2	Off	On
3	On	Off
4	On	On

Table 3: Address 2 for Group B ON/OFF State.

Address 3: LED Group A ON/OFF Control

Data	A1	A2	A3
1	Off	Off	Off
2	Off	Off	On
3	Off	On	Off
4	Off	On	On
5	On	Off	Off
6	On	Off	On
7	On	On	Off
8	On	On	On

Table 4: Address 3 for Group A ON/OFF State.

Address 4: LED Groups A & B ON Control

B2	B1	A1	A2	A3
On	On	On	On	On

Table 5: Address 4 for Turning Group A and B All On.

Address 4 turns on all channels with the current programmed by Addresses 0 and 1. No DATA needs to be provided.

AS²Cwire Serial Interface Timing

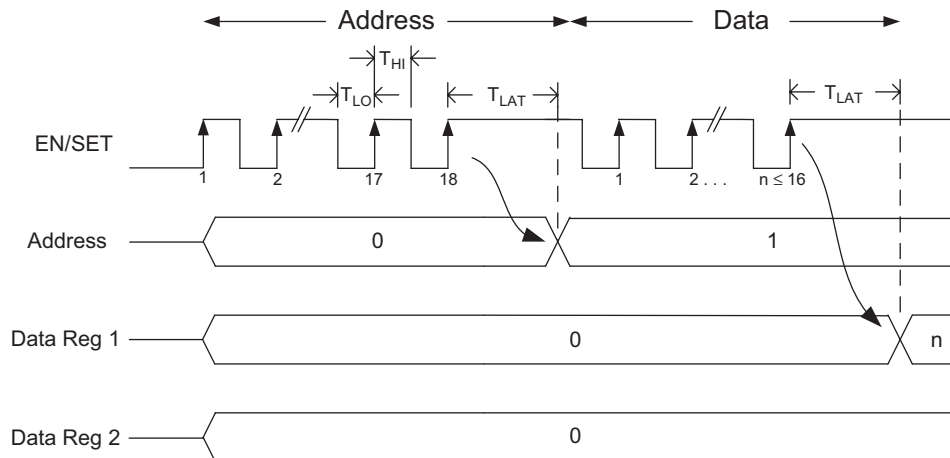

Application Information

Channel Disable

Tie all unused channels to AGND. On start-up, these channels will be automatically disabled.

LED Selection

Although the AAT1235 is specifically designed to drive white LEDs, the device can also be used to drive most types of LEDs with forward voltages ranging between 2.0V and 4.7V. Since the A1, A2, A3, and B1, B2 input current sinks are matched with low voltage dependence, the LED-to-LED brightness will be matched regardless of the individual LED forward voltage (V_F) levels. In some instances, it may be necessary to drive high- V_F type LEDs. The low dropout ($\sim 0.1V @ 20mA I_{LED}$) current sinks in the AAT1235 make it capable of driving LEDs with forward voltages as high as 4.7V from an input supply as low as 3.0V. LED outputs A1-A3 and B1-B2 can be combined to drive high-current LEDs without complication, making the AAT1235 a perfect application for large LCD display backlighting and keypad LED applications.

Constant Current Setting

The LED current is controlled by the R_{SET} resistor. For maximum accuracy, a 1% tolerance resistor is recommended. Table 6 shows the R_{SET} resistor value for AAT1235 for various LED full-scale current levels.

I_{LED} (mA)	R_{SET} (k Ω)
30	14.7
25	17.4
20	22.6
15	29.4
10	44.2
5	93.1

Table 6: Maximum LED Current and R_{SET} Resistor Values (1% Resistor Tolerance).

Maximum LED current per channel versus R_{SET} value is shown in Figure 1.

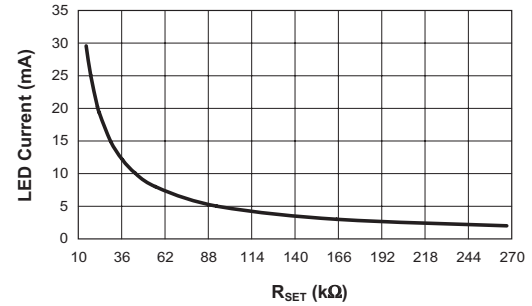

Figure 1: LED Current vs. R_{SET} Values.

Over-Voltage Protection

The over-voltage protection circuit consists of a resistor network connected from the output voltage to the OV pin (see Figure 2). This over voltage protection circuit prevents damage to the device when one of the five channels has an open LED circuit. The AAT1235 continues to operate; however, the LED current in the remaining channels is no longer regulated and the actual LED current will be determined by the externally programmed over-voltage protection threshold, the inductor value, and the switching frequency.

The resistor divider can be selected such that the over-voltage threshold occurs prior to the output reaching 24V ($V_{OUT(MAX)}$). The value of R_3 should be selected from 10k Ω to 20k Ω to minimize switching losses without degrading noise immunity:

$$R_2 = R_3 \cdot \left(\frac{V_{OUT(PROTECTION)}}{V_{OV}} - 1 \right)$$

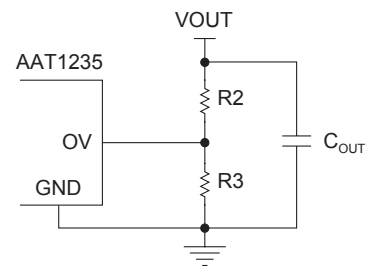

Figure 2: Over-Voltage Protection Circuit.

If four LEDs are connected in series on one channel, the total V_F from the WLEDs could be as high as 18.8V. Therefore, using $R3 = 12.1k\Omega$ and setting $V_{OUT(Protection)} = 20V$ is recommended. Selecting a 1% resistor, this results in $R2 = 187k\Omega$ (rounded to the nearest standard 1% value).

It is always recommended to use the same number of WLEDs on each channel and set the appropriate over-voltage protection. Failure to do so may cause any one of the (5) sink pins to exceed the absolute maximum rating voltage and permanently damage the device in case the channel is disconnected (open circuit failure). Examples of over voltage settings for various strings of series-connected LEDs are shown in Table 7.

Number of WLEDs on Each Channel	Total Maximum V_F (V)	$V_{OUT(Protection)}$ (V)	$R3 = 12.1k\Omega$	
			$R2$ (k Ω)	
4	18.8	20	187	
3	14.1	15	140	
2	9.4	10	88.7	

Table 7: Over-Voltage Protection Settings.

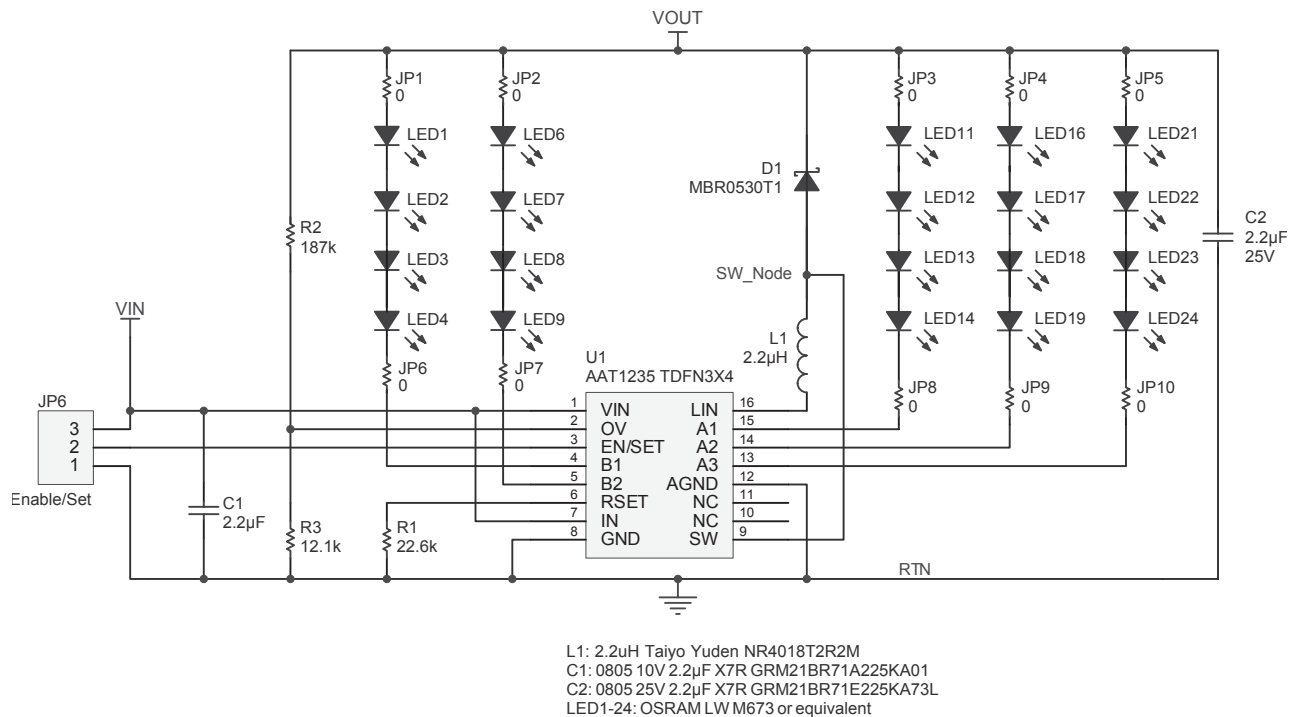

Figure 3: A AAT1235-based High Efficiency White LED Driver Schematic.

LED Brightness Control

The AAT1235 uses AS²Cwire programming to control LED brightness. The output current of the AAT1235 can be changed successively to brighten or dim the LEDs in smooth transitions (i.e., to fade in or fade out) or in discrete steps, giving the user complete programmability and real-time control of LED brightness.

Selecting the Schottky Diode

To ensure minimum forward voltage drop and no recovery, high voltage Schottky diodes are recommended for the AAT1235 boost converter. The output diode is selected to maintain acceptable efficiency and reasonable operating junction temperature under full load operating conditions. Forward voltage (V_F) and package thermal resistance (θ_{JA}) are the dominant factors in selecting a diode. The diode's non-repetitive peak forward surge current rating (I_{FSM}) should be considered for high pulsed load applications, such as camera flash. I_{FSM} rating drops with increasing conduction period. Manufacturers' datasheets should be reviewed carefully to verify reliability under peak loading conditions. The diode's published current rating may not reflect actual operating conditions and should be used only as a comparative measure between similarly rated devices.

20V rated Schottky diodes are recommended for output voltages less than 15V, while 30V rated Schottky diodes are recommended for output voltages higher than 15V.

Estimating Schottky Diode Power Dissipation

The switching period is divided between ON and OFF time intervals:

$$\frac{1}{F_S} = T_{ON} + T_{OFF}$$

During the ON time, the N-channel power MOSFET is conducting and storing energy in the boost inductor.

During the OFF time, the N-channel power MOSFET is not conducting. Stored energy is transferred from the input battery and boost inductor to the output load through the output diode.

Duty cycle is defined as the ON time divided by the total switching interval:

$$D = \frac{T_{ON}}{T_{ON} + T_{OFF}}$$

$$= T_{ON} \cdot F_S$$

The maximum duty cycle can be estimated from the relationship for a continuous mode boost converter. Maximum duty cycle (D_{MAX}) is the duty cycle at minimum input voltage ($V_{IN(MIN)}$):

$$D_{MAX} = \frac{V_{OUT} - V_{IN(MIN)}}{V_{OUT}}$$

The average diode current during the OFF time can be estimated:

$$I_{AVG(OFF)} = \frac{I_{OUT}}{1 - D_{MAX}}$$

The V_F of the Schottky diode can be estimated from the average current during the off time. The average diode current is equal to the output current:

$$I_{AVG(TOT)} = I_{OUT}$$

The average output current multiplied by the forward diode voltage determines the loss of the output diode:

$$P_{LOSS(DIODE)} = I_{AVG(TOT)} \cdot V_F$$

$$= I_{OUT} \cdot V_F$$

For continuous LED currents, the diode junction temperature can be estimated:

$$T_{J(DIODE)} = T_{AMB} + \theta_{JA} \cdot P_{LOSS(DIODE)}$$

External Schottky diode junction temperature should be below 110°C, and may vary depending

on application and/or system guidelines. The diode θ_{JA} can be minimized with additional metal PCB area on the cathode. However, adding additional heat-sinking metal around the anode may degrade EMI performance. The reverse leakage current of the rectifier must be considered to maintain low quiescent (input) current and high efficiency under light load. The rectifier reverse current increases dramatically at elevated temperatures.

Manufacturer	Part Number	Rated $I_{F(AV)}$ Current (A) ¹	Rated Voltage (V)	Thermal Resistance (θ_{JA} , °C/W) ¹	Case
Diodes, Inc.	B0520WS	0.50	20	426	SOD-323
ON Semi	MBR130LSFT	1.00	30	325	SOD-123
ON Semi	MBR0530T	0.50	30	206	SOD-123

Table 8: Typical Surface Mount Schottky Rectifiers for Various Output Loads.
(select $T_J < 110^\circ\text{C}$ in application circuit).

Selecting the Boost Inductor

The AAT1235 controller utilizes hysteretic control and the switching frequency varies with output load and input voltage. The value of the inductor determines the maximum switching frequency of the boost converter. Increased output inductance decreases the switching frequency, resulting in higher peak currents and increased output voltage ripple. To maintain 2MHz maximum switching frequency and stable operation, an output inductor selected between 1.5µH and 2.7µH is recommended.

A better estimate of D_{MAX} is possible once V_F is known:

$$D_{MAX} = \frac{(V_{OUT} + V_F - V_{IN(MIN)})}{(V_{OUT} + V_F)}$$

Where V_F is the Schottky diode forward voltage. If not known or not provided by the manufacturer, a starting value of 0.5V can be used.

Manufacturer's specifications list both the inductor DC current rating, which is a thermal limitation, and peak inductor current rating, which is determined by the saturation characteristics. Measurements at full load and high ambient temperature should be performed to ensure that the inductor does not saturate or exhibit excessive temperature rise.

The output inductor (L) is selected to avoid saturation at minimum input voltage and maximum output load conditions. Peak current may be estimated using the following equation, assuming continuous conduction mode. Worst-case peak current occurs at minimum input voltage (maximum duty cycle) and maximum load. Switching frequency (F_S) can be estimated at 500kHz with a 2.2µH inductor:

$$I_{PEAK} = \frac{I_{OUT}}{(1 - D_{MAX})} + \frac{D_{MAX} \cdot V_{IN(MIN)}}{(2 \cdot F_S \cdot L)}$$

At light load and low output voltage, the controller reduces the operating frequency to maintain maximum operating efficiency. As a result, further reduction in output load does not reduce the peak current. Minimum peak current can be estimated between 0.5A and 0.75A.

At high load and high output voltages, the switching frequency is somewhat diminished, resulting in higher I_{PEAK} . Bench measurements are recommended to confirm actual I_{PEAK} and to ensure that the inductor does not saturate at maximum LED current and minimum input supply voltage.

The RMS current flowing through the boost inductor is equal to the DC plus AC ripple components. Under worst-case RMS conditions, the current

waveform is critically continuous. The resulting RMS calculation yields worst-case inductor loss. The RMS current value should be compared against the inductor manufacturer's temperature rise, or thermal derating, guidelines:

$$I_{RMS} = \frac{I_{PEAK}}{\sqrt{3}}$$

For a given inductor type, smaller inductor size leads to an increase in DCR winding resistance and, in most cases, increased thermal impedance. Winding resistance degrades boost converter efficiency and increases the inductor's operating temperature:

$$P_{LOSS(INDUCTOR)} = I_{RMS}^2 \cdot DCR$$

To ensure high reliability, the inductor case temperature should not exceed 100°C. In some cases, PCB heatsinking applied to the LIN node (non-switching) can improve the inductor's thermal capability. However, as in the case of adding extra metal around the Schottky's anode, adding extra PCB metal around the AAT1235's SW pin for heatsinking may degrade EMI performance.

Shielded inductors provide decreased EMI and may be required in noise sensitive applications. Unshielded chip inductors provide significant space savings at a reduced cost compared to shielded (wound and gapped) inductors. In general, chip-type inductors have increased winding resistance (DCR) when compared to shielded, wound varieties.

Manufacturer	Part Number	Inductance (μH)	Max DC I _{SAT} Current (A)	DCR (Ω)	Size (mm) LxWxH	Type
Sumida	CDRH4D22/HP-2R2	2.2	2.50	35	5.0x5.0x2.4	Shielded
Sumida	CDR4D11/HP-2R4	2.4	1.70	105	4.8x4.8x1.2	Shielded
Sumida	CDRH4D18-2R2	2.2	1.32	75	5.0x5.0x2.0	Shielded
Murata	LQH662N2R2M03	2.2	3.30	19	6.3x6.3x4.7	Shielded
Murata	LQH55DN2R2M03	2.2	3.20	29	5.0x5.7x4.7	Non-Shielded
Taiyo Yuden	NR4018T2R2	2.2	2.70	60	4.0x4.0x1.8	Shielded
Taiyo Yuden	NR3015T2R2	2.2	1.48	60	3.0x3.0x1.5	Shielded
Coiltronics	SD3814-2R2	2.2	1.90	77	3.8x3.8x1.4	Shielded
Coiltronics	SD3114-2R2	2.2	1.48	86	3.1x3.1x1.4	Shielded
Coiltronics	SD3112-2R2	2.2	1.12	140	3.1x3.1x1.2	Shielded

Table 9: Typical Surface Mount Inductors for Various Output Loads
(select I_{PEAK} < I_{SAT}).

Selecting the Boost Capacitors

The high output ripple inherent in the boost converter necessitates the use of low impedance output filtering.

Multi-layer ceramic (MLC) capacitors provide small size and adequate capacitance, low parasitic equivalent series resistance (ESR) and equivalent series inductance (ESL), and are well suited for use with the AAT1235 boost regulator. MLC capacitors of type X7R or X5R are recommended to ensure good capacitance stability over the full operating temperature range.

The output capacitor is selected to maintain the output load without significant voltage droop (ΔV_{OUT})

during the power switch ON interval, when the output diode is not conducting. A ceramic output capacitor between 2.2μF and 4.7μF is recommended (see Table 8). Typically, 25V rated capacitors are required for the 24V maximum boost output. Ceramic capacitors selected as small as 0805 are available which meet these requirements.

MLC capacitors exhibit significant capacitance reduction with applied voltage. Output ripple measurements should confirm that output voltage droop and operating stability are within acceptable limits. Voltage derating can minimize this factor, but results may vary with package size and among specific manufacturers.

Output capacitor size can be estimated at a switching frequency (F_S) of 500kHz (worst case):

$$C_{OUT} = \frac{I_{OUT} \cdot D_{MAX}}{F_S \cdot \Delta V_{OUT}}$$

To maintain stable operation at full load, the output capacitor should be selected to maintain ΔV_{OUT} between 100mV and 200mV.

The boost converter input current flows during both ON and OFF switching intervals. The input ripple current is less than the output ripple and, as a result, less input capacitance is required.

Manufacturer	Part Number	Value (μ F)	Voltage Rating	Temp Co	Case Size
Murata	GRM188R60J225KE19	2.2	6.3	X5R	0603
Murata	GRM21BR71A225KA01	2.2	10	X7R	0805
Murata	GRM219R61E225KA12	2.2	25	X5R	0805
Murata	GRM21BR71E225KA73L	2.2	25	X7R	0805
Murata	GRM21BR61E475KA12	4.7	25	X5R	0805

Table 10: Recommended Ceramic Capacitors.

PCB Layout Guidelines

Boost converter performance can be adversely affected by poor layout. Possible impact includes high input and output voltage ripple, poor EMI performance, and reduced operating efficiency. Every attempt should be made to optimize the layout in order to minimize parasitic PCB effects (stray resistance, capacitance, and inductance) and EMI coupling from the high frequency SW node. A suggested PCB layout for the AAT1235 boost converter is shown in Figures 4 and 5. The following PCB layout guidelines should be considered:

1. Minimize the distance from Capacitor C1 and C2's negative terminals to the GND pins. This is especially true with output capacitor C2, which conducts high ripple current from the output diode back to the GND pins.
2. Minimize the distance between L1 to D1 and switching pin SW; minimize the size of the PCB area connected to the SW pin.
3. Maintain a ground plane and connect to the IC GND pin(s) as well as the GND connections of C1 and C2.
4. Consider additional PCB metal on D1's cathode to maximize heatsinking capability. This may be necessary when using a diode with a high V_F and/or thermal resistance.
5. Do not connect the exposed paddle (bottom of the die) to either AGND or GND because it is connected internally to SW. Connect the exposed paddle to the SW pin or leave floating.

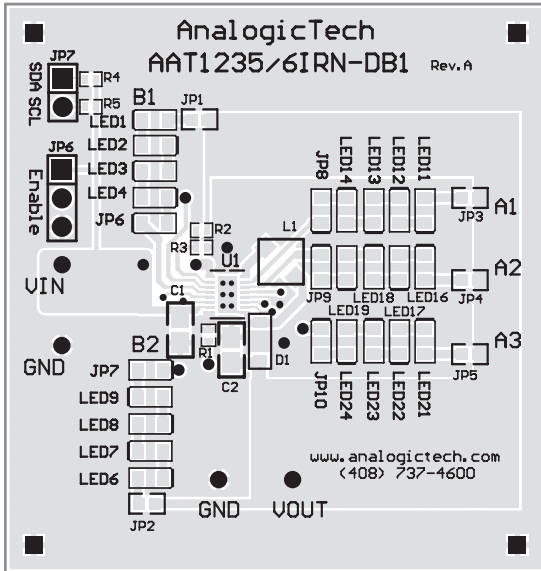

**Figure 4: AAT1235 Evaluation Board
Top Side Layout.**

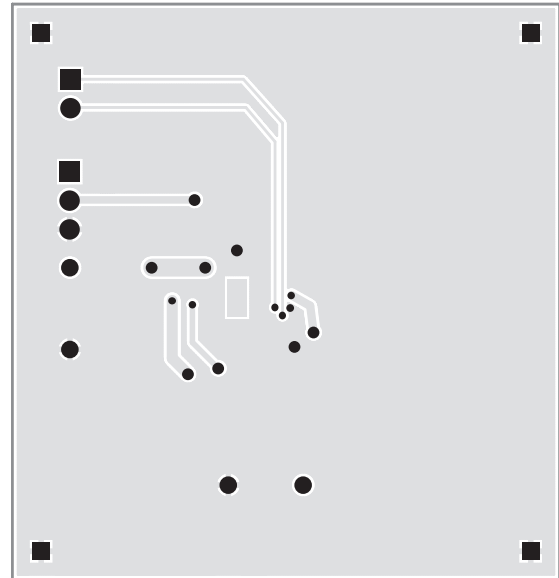

**Figure 5: AAT1235 Evaluation Board
Bottom Side Layout.**

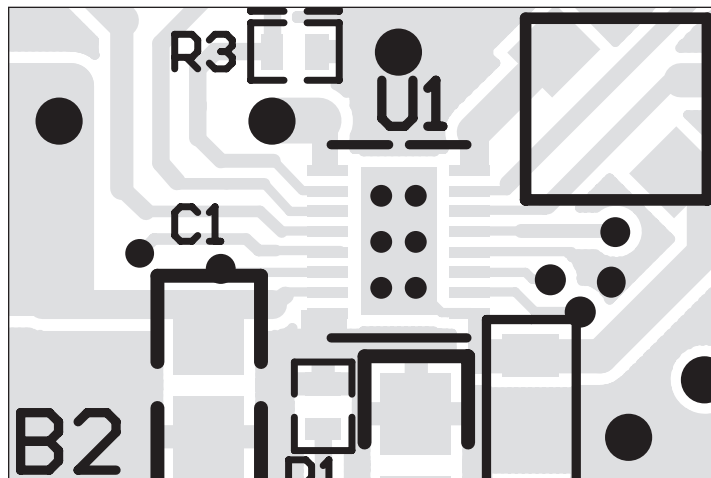

**Figure 6: Exploded View of AAT1235 Evaluation Board
Top Side Layout Detailing Plated Through Vias.**

Ordering Information

Package	Marking ¹	Part Number (Tape and Reel) ²
TDFN34-16	TKXYY	AAT1235IRN-T1



All AnalogicTech products are offered in Pb-free packaging. The term “Pb-free” means semiconductor products that are in compliance with current RoHS standards, including the requirement that lead not exceed 0.1% by weight in homogeneous materials. For more information, please visit our website at <http://www.analogictech.com/pbfree>.

Package Information³

TDFN34-16

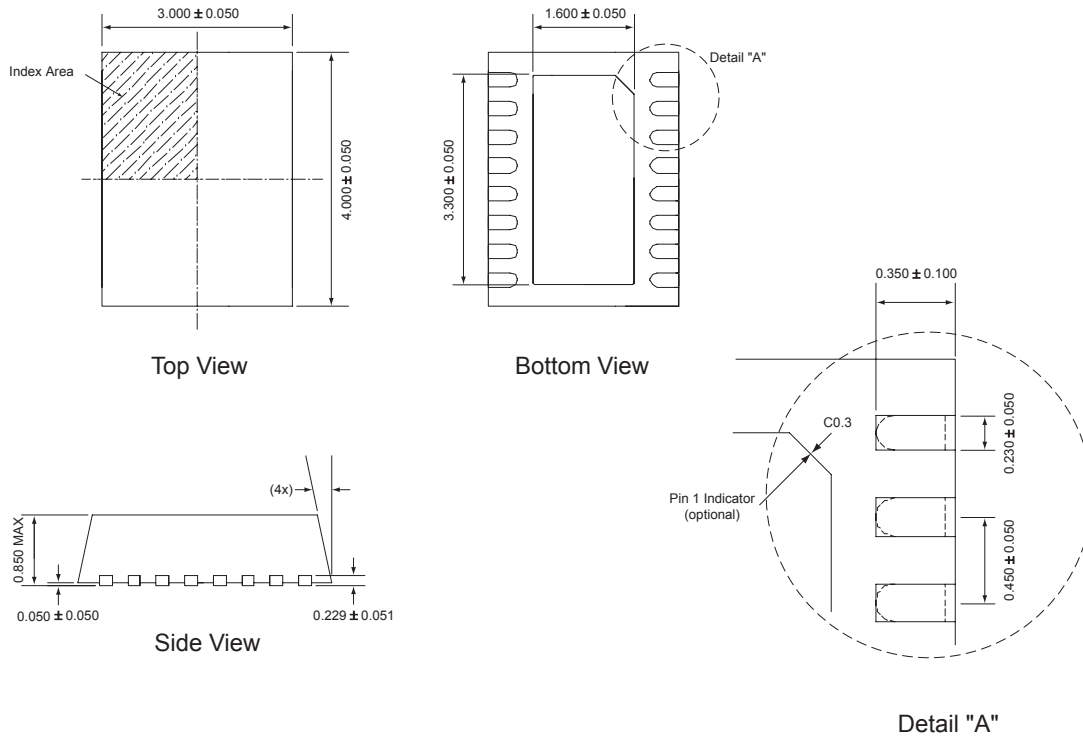

All dimensions in millimeters.

1. XYY = assembly and date code.
2. Sample stock is generally held on part numbers listed in **BOLD**.
3. The leadless package family, which includes QFN, TQFN, DFN, TDFN and STDFN, has exposed copper (unplated) at the end of the lead terminals due to the manufacturing process. A solder fillet at the exposed copper edge cannot be guaranteed and is not required to ensure a proper bottom solder connection.

© Advanced Analogic Technologies, Inc.

AnalogicTech cannot assume responsibility for use of any circuitry other than circuitry entirely embodied in an AnalogicTech product. No circuit patent licenses, copyrights, mask work rights, or other intellectual property rights are implied. AnalogicTech reserves the right to make changes to their products or specifications or to discontinue any product or service without notice. Customers are advised to obtain the latest version of relevant information to verify, before placing orders, that information being relied on is current and complete. All products are sold subject to the terms and conditions of sale supplied at the time of order acknowledgement, including those pertaining to warranty, patent infringement, and limitation of liability. AnalogicTech warrants performance of its semiconductor products to the specifications applicable at the time of sale in accordance with AnalogicTech's standard warranty. Testing and other quality control techniques are utilized to the extent AnalogicTech deems necessary to support this warranty. Specific testing of all parameters of each device is not necessarily performed.

AnalogicTech and the AnalogicTech logo are trademarks of Advanced Analogic Technologies Incorporated. All other brand and product names appearing in this document are registered trademarks or trademarks of their respective holders.

Advanced Analogic Technologies, Inc.
830 E. Arques Avenue, Sunnyvale, CA 94085
Phone (408) 737-4600
Fax (408) 737-4611