

### General Description

The AAT3164 is a low noise, constant frequency charge pump DC/DC converter that uses a tri-mode load switch (1X), fractional (1.5X), and doubling (2X) conversion to maximize efficiency for white LED applications. The device is capable of driving up to six channels of LEDs at up to 30mA per channel from a 2.7V to 5.5V input. The current sinks may be operated individually or in parallel for driving higher-current LEDs. A low external parts count (two 1 $\mu$ F flying capacitors and two small 1 $\mu$ F capacitors at IN and OUT) makes this part ideally suited for small, battery-powered applications.

AnalogicTech's patented single-wire Simple Serial Control™ (S<sup>2</sup>Cwire™) serial digital input is used to enable, disable, and set current for each LED with 16 levels from a maximum of 40mA down to 50 $\mu$ A. The maximum current level is programmed via an external resistor. To save power, the low-current mode supply current can be programmed as low as 70 $\mu$ A.

Each output of the AAT3164 is equipped with built-in protection for V<sub>OUT</sub> short-circuit and auto-disable for LED short-circuit conditions. Built-in soft-start circuitry prevents excessive inrush current during start-up. A low-current shutdown feature disconnects the load from V<sub>IN</sub> and reduces quiescent current to less than 1 $\mu$ A.

The AAT3164 is available in a Pb-free, space-saving, ultra-thin (3x4x0.75mm), thermally-enhanced 16-pin TDFN package.

### Features

- V<sub>IN</sub> Range: 2.7V to 5.5V
- Tri-Mode (1X/1.5X/2X) Charge Pump Operation
  - Maximizes Efficiency and LED V<sub>F</sub> Coverage
  - 1MHz Constant Switching Frequency
  - No Inductors, Low Noise Operation
- Drives Six Channels of LEDs up to 30mA/Channel
  - User-Programmable R<sub>SET</sub> Sets Maximum LED Current
  - Excellent LED Channel-to-Channel Current Match
- Digitally Programmable LED Current with Single-Wire S<sup>2</sup>Cwire Interface
  - 16 Current Levels From I<sub>LED\_MAX</sub> to 50 $\mu$ A
- Low I<sub>Q</sub> (70 $\mu$ A) for Low Current Mode Operation
- True Load Disconnect in Shutdown; I<sub>Q</sub> < 1 $\mu$ A
- Built-In Thermal Protection
- Built-In Auto-Disable for Open LED Circuit
- Automatic Soft-Start Minimizes Inrush Startup Current
- Small 3x4mm TDFN34-16 Package

### Applications

- Color (RGB) Lighting
- Programmable Current Sinks
- White LED Backlighting
- White Photo Flash for Digital Still Cameras

### Typical Application

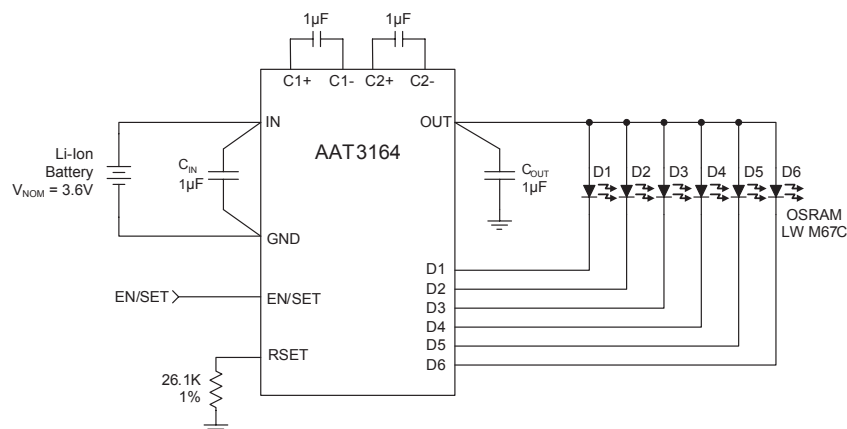

### Pin Descriptions

Pin #	Symbol	Function
1	D5	Current sink input #5.
2	D6	Current sink input #6.
3	RSET	Connect resistor here to set maximum output current level. 1% resistor is recommended.
4	EN/SET	Enable Input or S <sup>2</sup> Cwire serial interface control.
5	C1+	Flying Capacitor 1 positive terminal. Connect a 1μF ceramic capacitor between C1+ and C1-.
6	C1-	Flying Capacitor 1 negative terminal.
7	OUT	Charge pump output to drive load circuit. Requires 1μF ceramic capacitor connected between this pin and ground.
8	C2+	Flying Capacitor 2 positive terminal. Connect a 1μF ceramic capacitor between C2+ and C2-.
9	C2-	Flying Capacitor 2 negative terminal.
10, 12	GND	Ground.
11	IN	Input power supply. Requires 1μF ceramic capacitor connected between this pin and ground.
13	D1	Current sink input #1.
14	D2	Current sink input #2.
15	D3	Current sink input #3.
16	D4	Current sink input #4.
EP		Exposed paddle; connect to GND directly beneath the package.

### Pin Configuration

**TDFN34-16  
(Top View)**

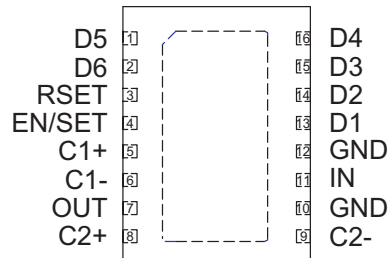

### Absolute Maximum Ratings<sup>1</sup>

Symbol	Description	Value	Units
$V_{IN}$	Input Voltage	-0.3 to 6	V
$V_{EN/SET}$	EN/SET to GND Voltage	-0.3 to $V_{IN} + 0.3$	V
$I_{OUT}^2$	Maximum DC Output Current	300	mA
$T_J$	Operating Junction Temperature Range	-40 to 150	°C
$T_{LEAD}$	Maximum Soldering Temperature (at leads, 10 sec)	300	°C

### Thermal Information<sup>3</sup>

Symbol	Description	Value	Units
$P_D$	Maximum Power Dissipation <sup>4</sup>	2	W
$\theta_{JA}$	Maximum Thermal Resistance	50	°C/W

1. Stresses above those listed in Absolute Maximum Ratings may cause permanent damage to the device. Functional operation at conditions other than the operating conditions specified is not implied. Only one Absolute Maximum Rating should be applied at any one time.
2. Based on long-term current density limitation.
3. Mounted on an FR4 board.
4. Derate 20mW/°C above 25°C.

### Electrical Characteristics<sup>1</sup>

$C_{IN} = C_{OUT} = C_1 = C_2 = 1\mu\text{F}$ ;  $T_A = -40^\circ\text{C}$  to  $+85^\circ\text{C}$ , unless otherwise noted. Typical values are  $T_A = 25^\circ\text{C}$ ,  $V_{IN} = 3.6\text{V}$ .

Symbol	Description	Conditions	Min	Typ	Max	Units
<b>Input Power Supply</b>						
$V_{IN}$	Operation Range		2.7		5.5	V
$I_{CC}$	Operating Current	1X Mode, $3.0\text{V} \leq V_{IN} \leq 5.5\text{V}$ , Active, No Load Current		0.3	1	mA
		1.5X Mode, $3.0\text{V} \leq V_{IN} \leq 5.5\text{V}$ , Active, No Load Current		1	3	
		2X Mode, $3.0\text{V} \leq V_{IN} \leq 5.5\text{V}$ , Active, No Load Current		1	3	
		50 $\mu\text{A}$ LED Current Setting, 1X Mode		70		$\mu\text{A}$
$I_{SHDN}$	Shutdown Current	EN/SET = 0			1	$\mu\text{A}$
$I_{DX}$	$I_{SINK}$ Average Current Accuracy	$T_A = -20^\circ\text{C}$ to $+85^\circ\text{C}$ , $R_{SET} = 26.1\text{k}\Omega$ , Data = 1 (100%)	-7	$\pm 2$	7	%
		$T_A = -40^\circ\text{C}$ to $+85^\circ\text{C}$ , $R_{SET} = 26.1\text{k}\Omega$ , Data = 1 (100%)	-8	$\pm 2$	8	
		$T_A = -40^\circ\text{C}$ to $+85^\circ\text{C}$ , $R_{SET} = 26.1\text{k}\Omega$ , Data = 12 (14%)	-20		20	
		$T_A = 25^\circ\text{C}$ , Data = 14 (1mA)	-10		10	
$I_{(D-Match)}$	Current Matching <sup>2</sup>			0.5	1	%
$V_{TH}$	1X to 1.5X or 1.5X to 2X Transition Threshold at Any $I_{SINK}$ Pin			150		mV
$I_{SET}$	Current Set Ratio	$I_{SINK}/I_{RSET}$		870		A/A
$V_{RSET}$	RSET Pin Voltage			0.6		V
<b>Charge Pump Section</b>						
$T_{SS}$	Soft-Start Time	Output Ramp Up Time		100		$\mu\text{s}$
$F_{CLK}$	Clock Frequency			1000		kHz
<b>EN/SET</b>						
$V_{EN(L)}$	Enable Threshold Low				0.4	V
$V_{EN(H)}$	Enable Threshold High		1.4			V
$T_{EN/SET LO}$	EN/SET Low Time		0.3		75	$\mu\text{s}$
$T_{EN/SET HI(MIN)}$	Minimum EN/SET High Time			50		ns
$T_{EN/SET HI(MAX)}$	Maximum EN/SET High Time				75	$\mu\text{s}$
$T_{OFF}$	EN/SET Off Timeout				500	$\mu\text{s}$
$T_{LAT}$	EN/SET Latch Timeout				500	$\mu\text{s}$
$I_{EN/SET}$	EN/SET Input Leakage	$V_{EN/SET} = 5\text{V}$	-1		1	$\mu\text{A}$

- The AAT3164 is guaranteed to meet performance specifications over the  $-40^\circ\text{C}$  to  $+85^\circ\text{C}$  operating temperature range and is assured by design, characterization, and correlation with statistical process controls.
- Current matching is defined as the deviation of any sink current from the average of all active channels.

### Typical Characteristics

$C_{IN} = C_{OUT} = C_1 = C_2 = 1.0\mu\text{F}$ ;  $T_A = 25^\circ\text{C}$ ,  $R_{SET} = 26.1\text{k}\Omega$ ,  $V_{IN} = 3.6\text{V}$ , unless otherwise noted.

**Efficiency vs. Supply Voltage**

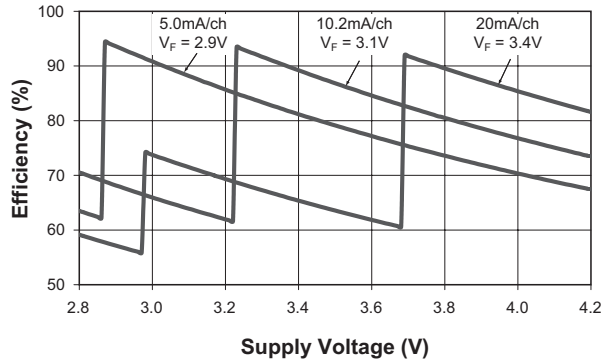

**Turn-On to 1X Mode**  
( $V_{IN} = 4.2\text{V}$ ; 20mA/Channel; Data 1)

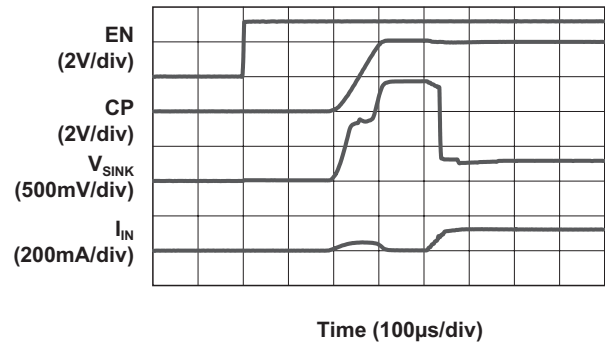

**Turn-On to 1.5X Mode**  
( $V_{IN} = 3.8\text{V}$ ; 20mA/Channel; Data 1)

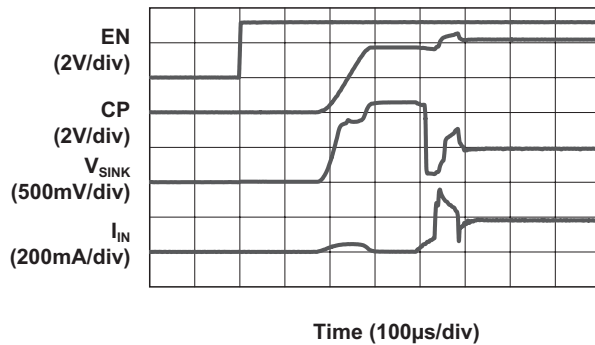

**Turn-On to 2X Mode**  
( $V_{IN} = 2.8\text{V}$ ; 20mA/Channel; Data 1)

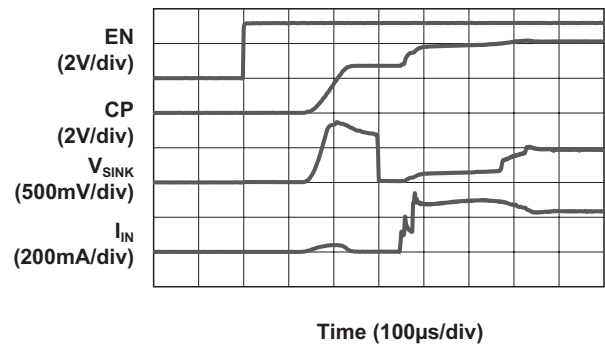

**Turn-Off from 1.5X Mode**  
( $V_{IN} = 3.5\text{V}$ ; 20mA/Channel; Data 1)

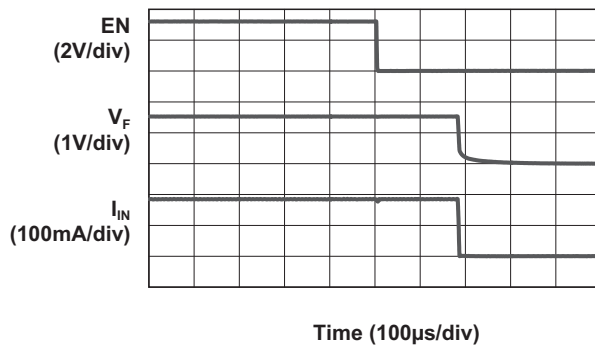

**Current Matching vs. Temperature**

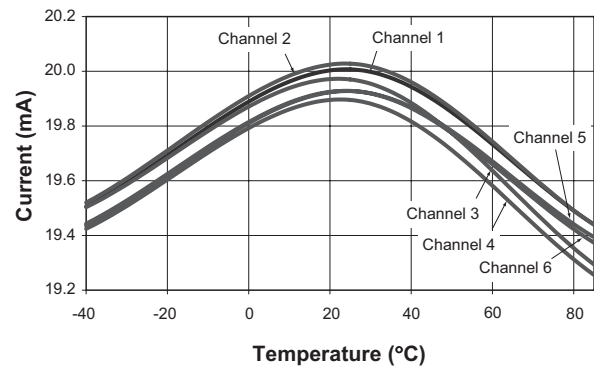

### Typical Characteristics

$C_{IN} = C_{OUT} = C_1 = C_2 = 1.0\mu\text{F}$ ;  $T_A = 25^\circ\text{C}$ ,  $R_{SET} = 26.1\text{k}\Omega$ ,  $V_{IN} = 3.6\text{V}$ , unless otherwise noted.

**Load Characteristics**  
( $V_{IN} = 3.8\text{V}$ ; 1.5X Mode; 14.2mA/Channel; Data 3)

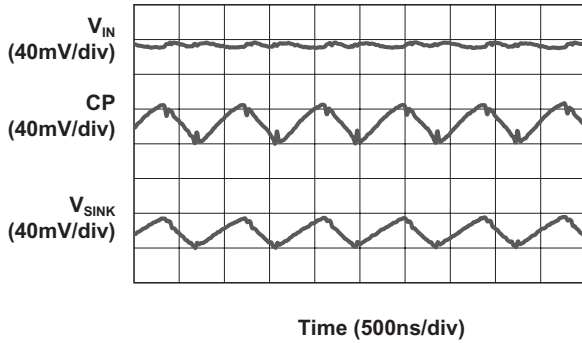

**Load Characteristics**  
( $V_{IN} = 2.9\text{V}$ ; 2X Mode; 14.2mA/Channel; Data 3)

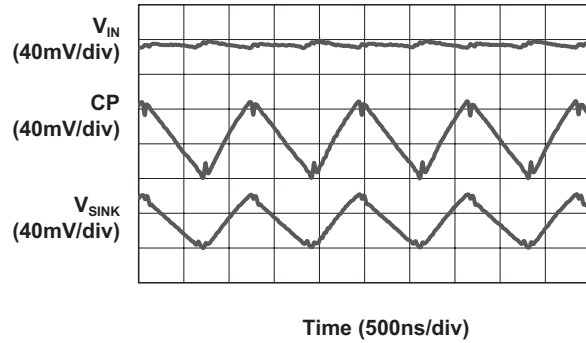

**Load Characteristics**  
( $V_{IN} = 4.0\text{V}$ ; 1.5X Mode; 20mA/Channel; Data 1)

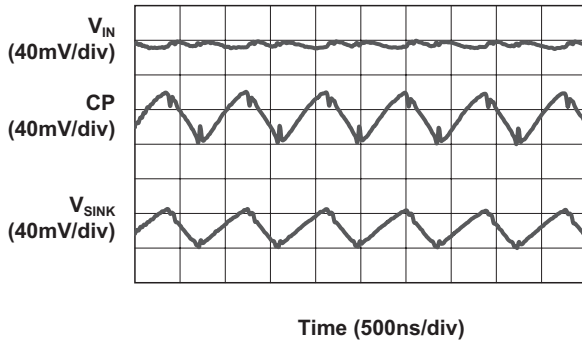

**Load Characteristics**  
( $V_{IN} = 3.1\text{V}$ ; 2X Mode; 20mA/Channel; Data 1)

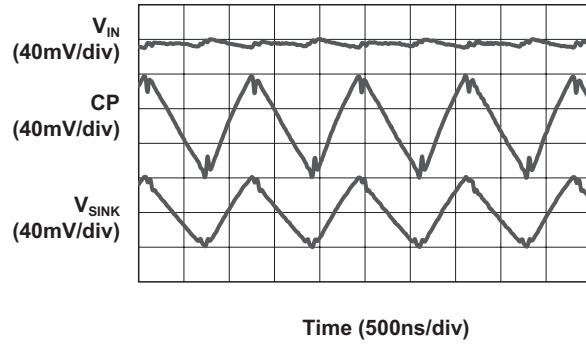

**$T_{LAT}$  vs.  $V_{IN}$**

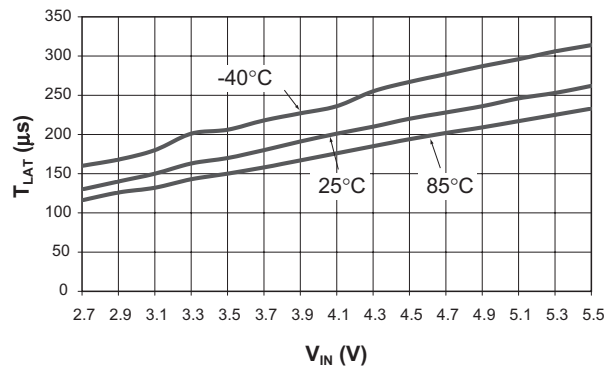

**$T_{OFF}$  vs.  $V_{IN}$**

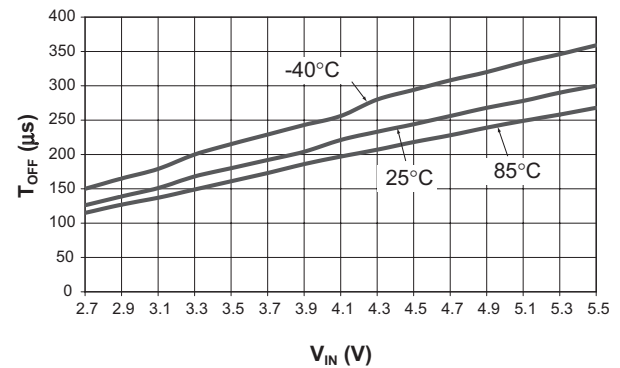

### Typical Characteristics

$C_{IN} = C_{OUT} = C_1 = C_2 = 1.0\mu\text{F}$ ;  $T_A = 25^\circ\text{C}$ ,  $R_{SET} = 26.1\text{k}\Omega$ ,  $V_{IN} = 3.6\text{V}$ , unless otherwise noted.

Maximum LED Current vs.  $R_{SET}$

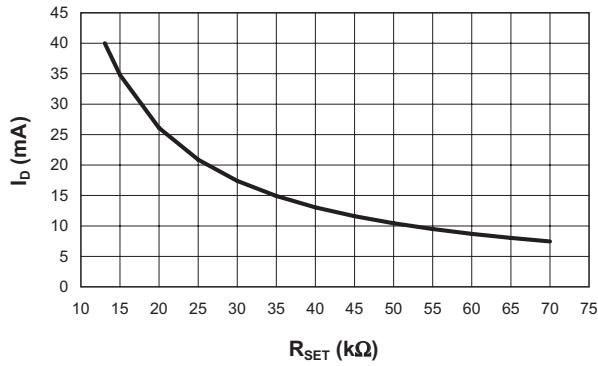

$V_{IH}$  vs.  $V_{IN}$

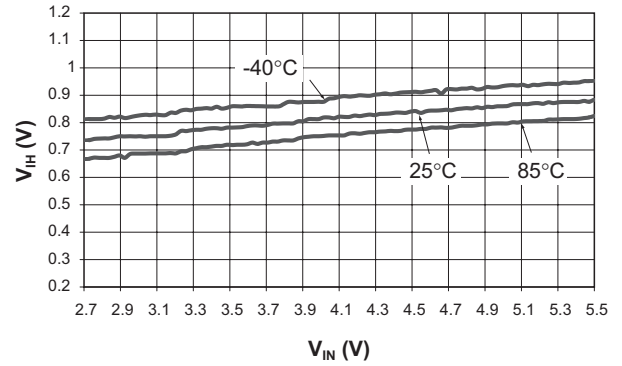

$V_{IL}$  vs.  $V_{IN}$

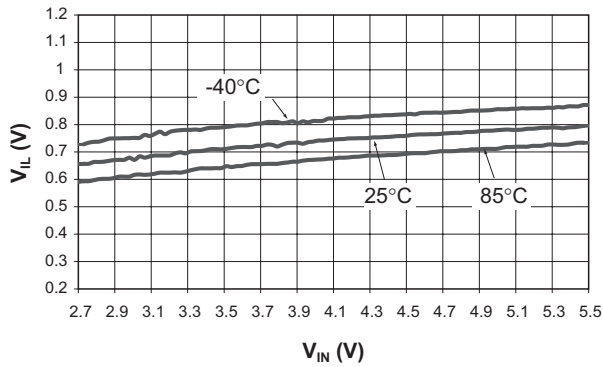

Input Ripple vs.  $V_{IN}$

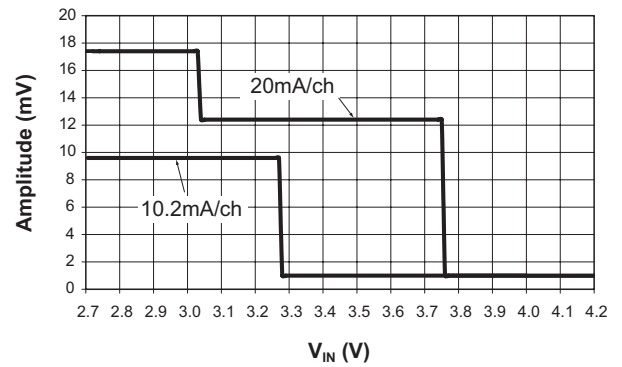

### Functional Block Diagram

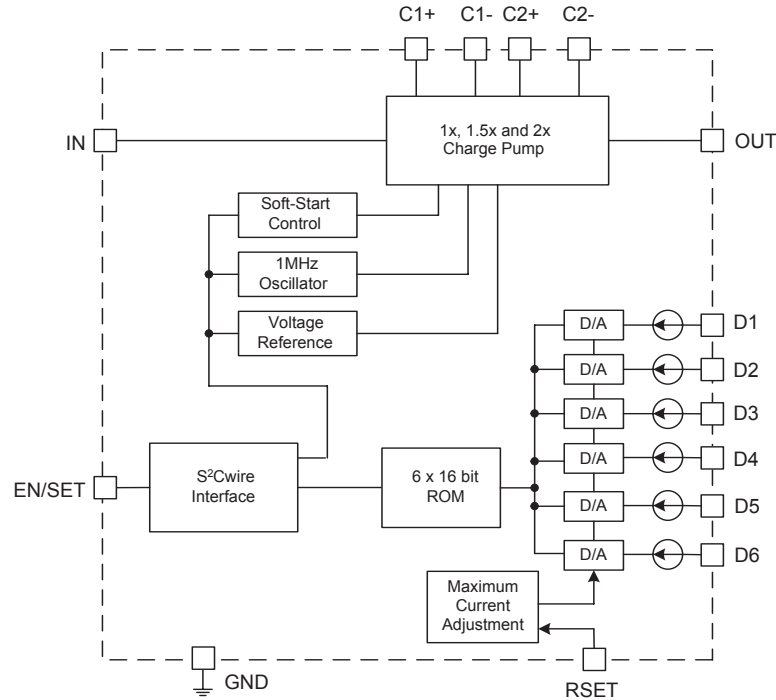

### Functional Description

The AAT3164 is a tri-mode load switch (1X) and high efficiency (1.5X or 2X) charge pump device intended for white LED backlight applications. To maximize power conversion efficiency, an internal sensing circuit monitors the voltage required on each constant current sink input and sets the load switch and charge pump modes based on the input battery voltage and the current sink input voltage. As the battery discharges over time, the AAT3164 charge pump is enabled when any of the six current sink inputs near dropout. The charge pump initially starts in 1.5X mode. If the charge pump output droops enough for any current sink input to become close to dropout, the charge pump will automatically transition to 2X mode. The AAT3164 requires only four external components: two 1 $\mu$ F ceramic capacitors for the charge pump flying capacitors ( $C_1$  and  $C_2$ ), one 1 $\mu$ F ceramic input capacitor ( $C_{IN}$ ), and one 0.33 $\mu$ F to 1 $\mu$ F ceramic charge pump output capacitor ( $C_{OUT}$ ).

The S<sup>2</sup>Cwire serial interface enables the AAT3164 and sets the current sink magnitudes. Since all current sinks are truly independent constant current sinks, the voltage observed on any single given input will be determined by the actual forward voltage ( $V_F$ ) for the LED being driven. Unused sink inputs must be connected to OUT, otherwise the part will operate in 2X charge pump mode only.

### Constant Current Output Level Settings

The current sink magnitude is controlled by AnalogicTech's S<sup>2</sup>Cwire serial digital input. The maximum current is programmed by an external resistor at the RSET pin. Since each current sink is programmable, no PWM (pulse width modulation) or additional control circuitry is needed to control LED brightness. This feature greatly reduces the burden on a microcontroller or system IC to manage LED or display brightness, allowing the user to "set it and forget it." With its high-speed serial interface (1MHz data rate), the input sink current can be changed quickly and easily. The code settings for the AAT3164 are listed in Table 1.



Data	All Outputs D1~D6
1	100%
2	84%
3	71%
4	60%
5	51%
6	43%
7	35%
8	30%
9	25%
10	21%
11	17%
12	14%
13	1.8mA
14	1mA
15	530μA
16	50μA

**Table 1: Current Level Settings as a Percentage of the Maximum Level Set by R<sub>SET</sub>.**

The built-in S<sup>2</sup>Cwire interface records rising edges of the EN/SET pin and decodes them into these current level settings. S<sup>2</sup>Cwire latches data after the EN/SET pin has been held high for time T<sub>LAT</sub>. A separate mode is available for ultra-low LED current

operation. This mode is enabled by setting Data 13 to 16. While the AAT3164 is operating in low current and 1X mode, the total quiescent current is reduced to typically 70μA. When EN/SET is held low for an amount of time longer than T<sub>OFF</sub> (500μs), the AAT3164 enters shutdown mode and draws less than 1μA from IN. Data register is reset to 0 during shutdown.

### Auto-Disable Feature

The AAT3164 is equipped with an auto-disable feature for each LED channel. After the IC is enabled, a test current of 150μA (typical) is forced through each sink channel. The LED must develop a forward voltage of 0.8V for the channel to turn on. This allows individual channels to be disabled by connecting the respective sink pin to OUT. This feature is convenient for disabling an unused channel or protecting against an LED fail short event.

### Thermal Protection

The AAT3164 has a built-in thermal protection circuit that will shut down the charge pump if the die temperature rises above the thermal limit, as is the case during a short-circuit of the OUT pin.

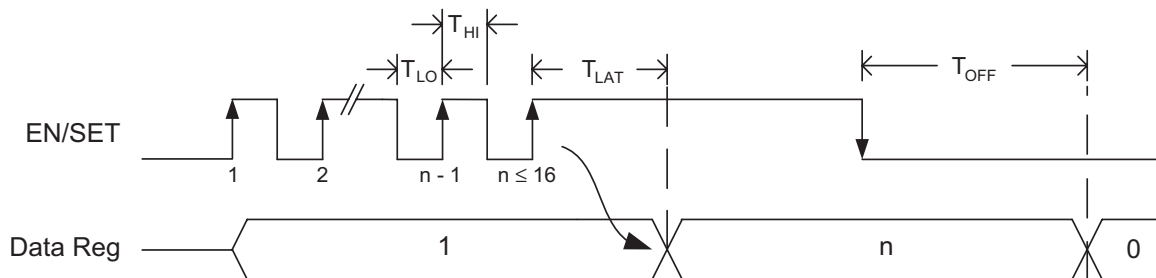

**Figure 1: S<sup>2</sup>Cwire Serial Interface Timing Diagram.**

### Applications Information

#### LED Selection

Although the AAT3164 is specifically designed to drive white LEDs, the device can also be used to drive most types of LEDs with forward voltage specifications ranging from 2.0V to 4.7V. LED applications may include LCD display backlighting, camera photo-flash applications, color (RGB) LEDs, infrared (IR) diodes for remotes, and other loads benefiting from a controlled output current generated from a varying input voltage. Since the D1 to D6 input current sinks are matched with negligible voltage dependence, the LED brightness will be matched regardless of the specific LED forward voltage ( $V_F$ ) levels. In some instances (e.g., in high luminous output applications such as photo flash), it may be necessary to drive high- $V_F$  type LEDs. The low dropout ( $\sim 0.1V$  @  $20mA$   $I_{LED}$ ) current sinks in the AAT3164 make it capable of driving LEDs with forward voltages as high as 4.7V from an input supply as low as 3.0V. Outputs can be paralleled to drive high-current LEDs without complication.

#### Determining the Maximum LED Current Level

The value of  $R_{SET}$  determines the maximum LED current level. In the typical application, selecting  $R_{SET} = 26.1k\Omega$  results in  $20mA/channel$  LED current. From this reference point, the  $R_{SET}$  value required for other current levels can be calculated as:

$$R_{SET} = \frac{20mA \cdot 26.1k\Omega}{I_{LED(MAX)}}$$

A visual representation of the maximum LED current per channel versus  $R_{SET}$  value is shown in Figure 2.

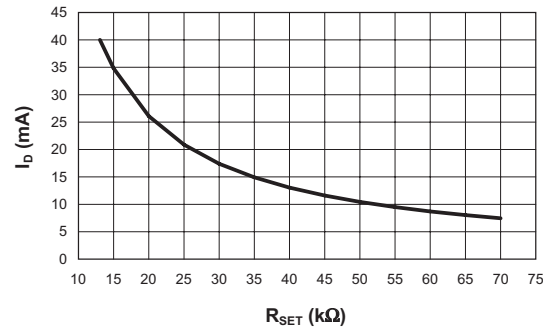

Figure 2: Maximum LED Current vs.  $R_{SET}$ .

#### Brightness Control Using the RSET Pin

Additional methods of brightness control can be achieved with the RSET pin. For example, using an additional resistor to connect the RSET pin with a digital output provides a HI/LO control. Figure 3 illustrates a configuration of the RSET pin utilizing two resistors.

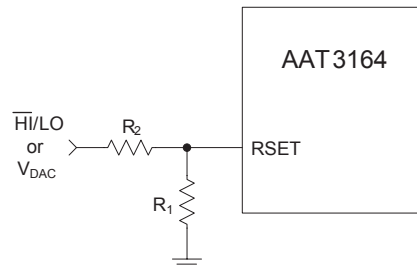

Figure 3: RSET Configuration Using Two Resistors.

When the digital output is asserted high, the resulting brightness level is LO and the individual LED currents are:

$$I_{LED(LO)} = 870 \left( \frac{0.6}{R_1 // R_2} - \frac{V_{IO}}{R_2} \right)$$

When the digital output is asserted low, the resulting brightness level is HI and the individual LED currents are:

$$I_{LED(HI)} = 870 \left( \frac{0.6}{R_1 // R_2} \right)$$

Additionally, a digital-to-analog converter can be used with the RSET pin to control the brightness level. The result is like the equation above, where  $V_{IO}$  is replaced with  $V_{DAC}$ :

$$I_{LED(LO)} = 870 \left( \frac{0.6}{R_1 // R_2} - \frac{V_{DAC}}{R_2} \right)$$

For cases where PWM dimming is preferred, the PWM signal can be applied directly to the RSET resistor, as shown in Figure 4. In order for the LED current to go to zero, the voltage level of the PWM signal must exceed the RSET pin voltage level of 0.6V.

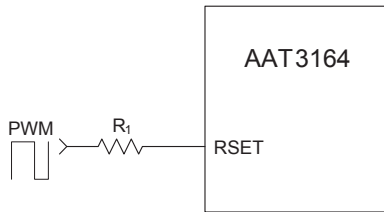

**Figure 4: RSET Configuration for PWM Dimming Control.**

### Device Power Efficiency

The AAT3164 power conversion efficiency depends on the charge pump mode. By definition, device efficiency is expressed as the output power delivered to the LEDs divided by the total input power consumed.

$$\eta = \frac{P_{OUT}}{P_{IN}}$$

When the input voltage is sufficiently greater than the LED forward voltages, the device optimizes efficiency by operating in 1X mode. In 1X mode, the device is working as a bypass switch and passing the input supply directly to the output. By simplifying the conditions such that the LEDs have uniform  $V_F$ , the power conversion efficiency can be approximated by:

$$\eta = \frac{V_F \cdot I_{LED}}{V_{IN} \cdot I_{IN}} \approx \frac{V_F}{V_{IN}}$$

Due to the very low 1X mode quiescent current, the input current nearly equals the total output current delivered to the LEDs. Further, the low resistance bypass switch introduces negligible voltage drop from input to output.

The AAT3164 further maintains optimized performance and efficiency by detecting when the input voltage is not sufficient to sustain LED drive current. The device automatically switches to 1.5X mode when the input voltage drops too low in relation to the LED forward voltages.

In 1.5X mode, the output voltage can be boosted to 3/2 the input voltage. The 3/2 conversion ratio introduces a corresponding 1/2 increase in input current. For ideal conversion, the 1.5X mode efficiency is given by:

$$\eta = \frac{V_F \cdot I_{LED}}{V_{IN} \cdot 1.5I_{IN}} \approx \frac{V_F}{1.5 \cdot V_{IN}}$$

Similarly, when the input falls further, such that 1.5X mode can no longer sustain LED drive current, the device will automatically switch to 2X mode. In 2X mode, the output voltage can be boosted to twice the input voltage. The doubling conversion ratio introduces a corresponding doubling of the input current. For ideal conversion, the 2X mode efficiency is given by:

$$\eta = \frac{V_F \cdot I_{LED}}{V_{IN} \cdot 2I_{IN}} \approx \frac{V_F}{2 \cdot V_{IN}}$$

### Additional Applications

The current sinks of the AAT3164 can be combined to drive higher current levels through a single LED. As an example, each LED of a three-die arrangement can be driven at 80mA each, or 240mA total (see Figure 5).

Other applications that require constant current can also be accommodated by combining constant current channels to achieve the necessary current levels.

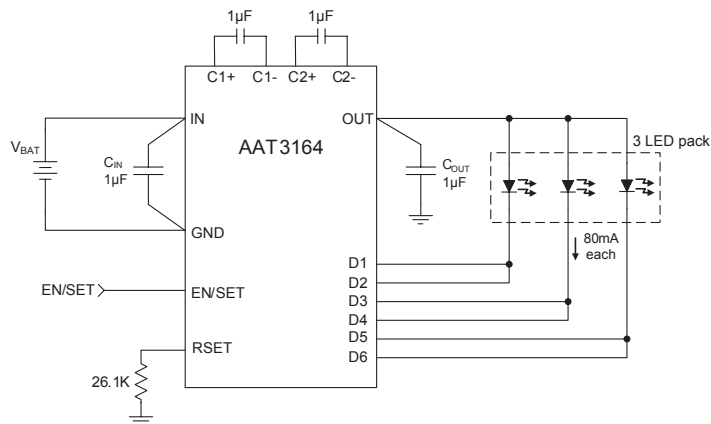

**Figure 5: Configuration for a Typical Three-LED Application.**

### Device Switching Noise Performance

The AAT3164 operates at a fixed frequency of approximately 1MHz to control noise and limit harmonics that can interfere with the RF operation of cellular telephone handsets or other communication devices. Back-injected noise appearing on the input pin of the charge pump is 20mV peak-to-peak, typically ten times less than inductor-based DC/DC boost converter white LED backlight solutions. The AAT3164 soft-start feature prevents noise transient effects associated with inrush currents during start-up of the charge pump circuit.

### Capacitor Selection

Careful selection of the four external capacitors  $C_{IN}$ ,  $C_1$ ,  $C_2$ , and  $C_{OUT}$  is important because they will affect turn-on time, output ripple, and transient performance. Optimum performance will be obtained when low equivalent series resistance (ESR) ceramic capacitors are used. In general, low ESR may be defined as less than 100mΩ. A value of 1µF for all four capacitors is a good starting point when choosing capacitors. If the LED current sources are only programmed for light current levels, then the capacitor value may be decreased.

### Capacitor Characteristics

Ceramic composition capacitors are highly recommended over all other types of capacitors for use with the AAT3164. Ceramic capacitors offer many advantages over their tantalum and aluminum electrolytic counterparts. A ceramic capacitor typically has very

low ESR, is lowest cost, has a smaller PCB footprint, and is non-polarized. Low ESR ceramic capacitors help maximize charge pump transient response. Since ceramic capacitors are non-polarized, they are not prone to incorrect connection damage.

### Equivalent Series Resistance

ESR is an important characteristic to consider when selecting a capacitor. ESR is a resistance internal to a capacitor that is caused by the leads, internal connections, size or area, material composition, and ambient temperature. Capacitor ESR is typically measured in milliohms for ceramic capacitors and can range to more than several ohms for tantalum or aluminum electrolytic capacitors.

### Ceramic Capacitor Materials

Ceramic capacitors less than 0.1µF are typically made from NPO or C0G materials. NPO and C0G materials generally have tight tolerance and are very stable over temperature. Larger capacitor values are usually composed of X7R, X5R, Z5U, or Y5V dielectric materials. Large ceramic capacitors (i.e., greater than 2.2µF) are often available in low-cost Y5V and Z5U dielectrics, but capacitors greater than 1µF are not typically required for AAT3164 applications.

Capacitor area is another contributor to ESR. Capacitors that are physically large will have a lower ESR when compared to an equivalent material smaller capacitor. These larger devices can improve circuit transient response when compared to an equal value capacitor in a smaller package size.

### Ordering Information

Package	Marking <sup>1</sup>	Part Number (Tape and Reel) <sup>2</sup>
TDFN34-16	QBXY	<b>AAT3164IRN-T1</b>



All AnalogicTech products are offered in Pb-free packaging. The term "Pb-free" means semiconductor products that are in compliance with current RoHS standards, including the requirement that lead not exceed 0.1% by weight in homogeneous materials. For more information, please visit our website at <http://www.analogictech.com/pbfree>.

### Package Information

#### TDFN34-16

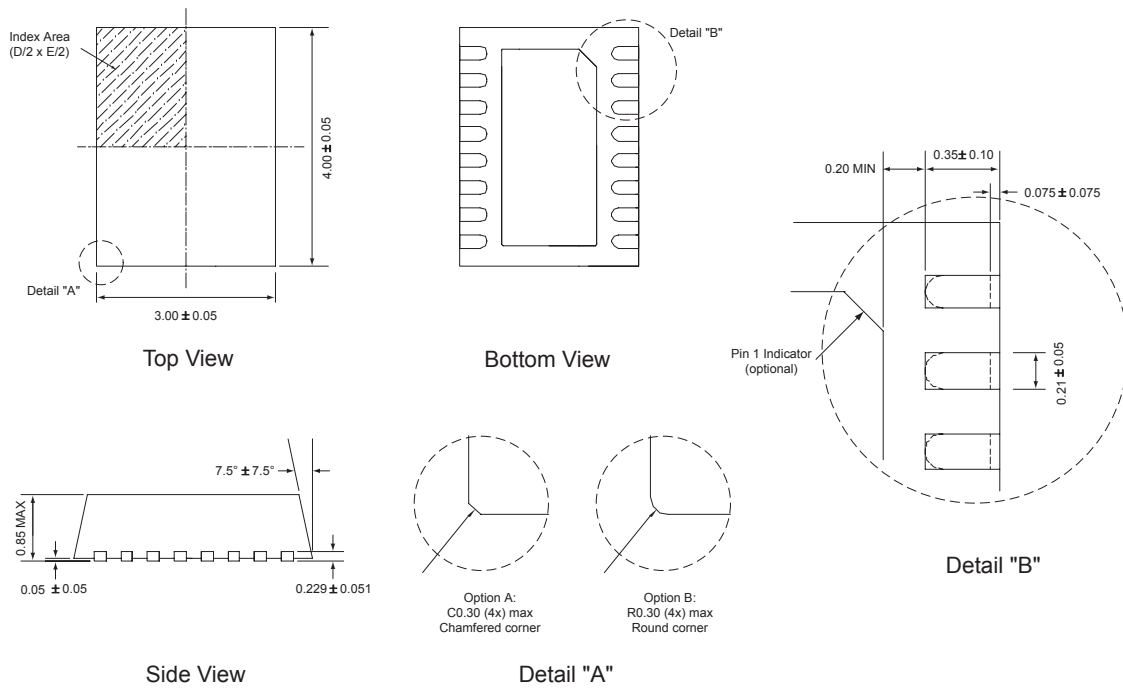

All dimensions in millimeters.

1. XYY = assembly and date code.  
 2. Sample stock is generally held on part numbers listed in **BOLD**.

© Advanced Analogic Technologies, Inc.

AnalogicTech cannot assume responsibility for use of any circuitry other than circuitry entirely embodied in an AnalogicTech product. No circuit patent licenses, copyrights, mask work rights, or other intellectual property rights are implied. AnalogicTech reserves the right to make changes to their products or specifications or to discontinue any product or service without notice. Customers are advised to obtain the latest version of relevant information to verify, before placing orders, that information being relied on is current and complete. All products are sold subject to the terms and conditions of sale supplied at the time of order acknowledgement, including those pertaining to warranty, patent infringement, and limitation of liability. AnalogicTech warrants performance of its semiconductor products to the specifications applicable at the time of sale in accordance with AnalogicTech's standard warranty. Testing and other quality control techniques are utilized to the extent AnalogicTech deems necessary to support this warranty. Specific testing of all parameters of each device is not necessarily performed.

AnalogicTech and the AnalogicTech logo are trademarks of Advanced Analogic Technologies Incorporated. All other brand and product names appearing in this document are registered trademarks or trademarks of their respective holders.

**Advanced Analogic Technologies, Inc.**  
**830 E. Arques Avenue, Sunnyvale, CA 94085**  
**Phone (408) 737-4600**  
**Fax (408) 737-4611**

