

Grand Earthing System Audio Signal Mute IC

FEATURES

- Wide Voltage Range (1.8 ~ 5.5 V)
- Very Low Signal Distortion (typ. 0.005%)
- High Maximum Input Voltage (max. 4.2 V_{p-p})
- Very Low Standby Current (typ. 0.1 mA)
- Minimal External Component Circuitry

APPLICATIONS

- Audio Systems
- Television
- VTR
- MD
- CD

DESCRIPTION

The TK15121M is a "MUTE IC" of the Grand Earthing System that was developed as a low frequency signal attenuation for audio products.

The mute function includes two channels which act simultaneously by one control key.

The optional time for the Attack/Release can be set up by the "Timing Control Capacitor".

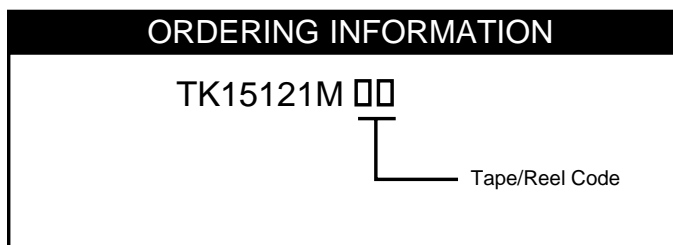
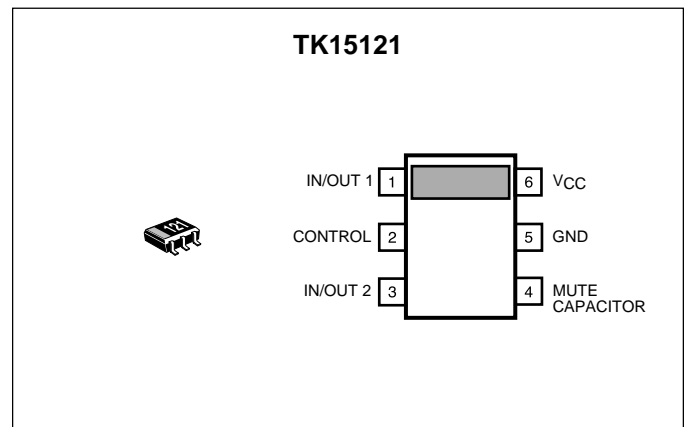

TAPE/REEL CODE
TL: Tape Left

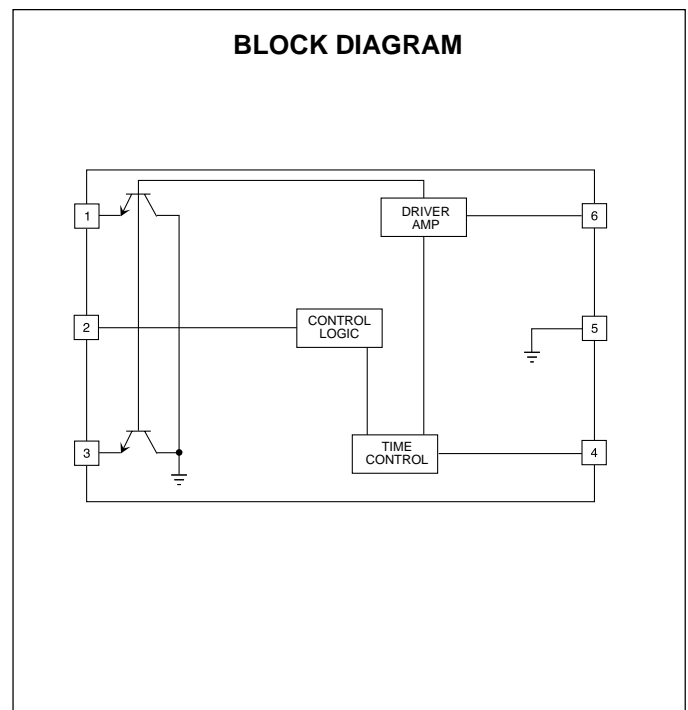

TK15121

ABSOLUTE MAXIMUM RATINGS

Supply Voltage (V_{CC} MAX) 10 V Storage Temperature Range -55 to +150 °C
 Power Dissipation (Note 3) 200 mW Operating Temperature Range -20 to +60 °C
 Maximum Input Frequency (f_{MAX}) 100 kHz

TK15121M ELECTRICAL CHARACTERISTICS

Test conditions: $V_{CC} = 3$ V, $T_A = 25$ °C, $f = 1$ kHz, $V_{IN} = 4$ V_{P-P} unless otherwise specified.

SYMBOL	PARAMETER	TEST CONDITIONS	MIN	TYP	MAX	UNITS
V_{CC}	Operating Voltage		1.8	3.0	5.5	V
$I_{CC\ OFF}$	Supply Current Mute Off Current			0.1	0.2	mA
$I_{CC\ ON}$	Supply Current Mute On Current			5.0	8.0	mA
ATT	Attenuation	$R_{IN} = 3$ k Ω , Note 1	54	57		-dB
CI_{ON}	Mute On Charge Current	Attack action. Note 2		10	16	μ A
CI_{OFF}	Mute Off Discharge Current	Release action. Note 2		6.0	9.0	μ A
SWV_{OFF}	Mute Control SW Mute Off Voltage		-0.3		0.5	V
SWV_{ON}	Mute Control SW Mute On Voltage		1.0		$V_{CC} + 0.3$	V
V_{OSAT}	Mute On Output Saturation Voltage			1.4		mV
THD	Mute Off Total Harmonic Distortion	$f = \sim 20$ kHz		0.005	0.007	%
GVA	Gain	$f = \sim 20$ kHz	-0.5	0	+0.5	dB
$V_{IN\ MAX}$	Maximum Input Voltage	THD = 0.01%			4.2	V _{P-P}

Note 1: If a R_{IN} other than 3 k Ω is used, then the volume attenuation and attack/release time changes.

Note 2: Attack is an action that changes to "mute on" from "mute off", and release is action that changes to "mute off" from "mute on".
 Standard capacity for the timing control is 0.22 μ F.

Note 3: Power dissipation is 200 mW when mounted as recommended. Derate at 1.6 mW/°C for operation above 25°C.

TEST CIRCUIT AND METHODS

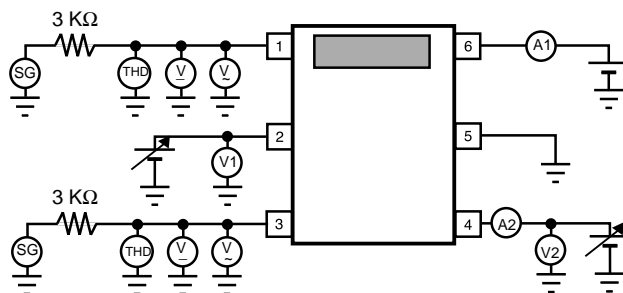

METHODS

- 1) Power supply current.
 - Power supply current in the 'MUTE OFF'.
When the control is 'Lo (or open)', measures the current 'A1'.
 - Power supply current in the 'MUTE ON'.
When the control is 'Hi', measures the current 'A1'.
- 2) Attenuation volume.
 - When the control is 'Hi', attenuation is calculated by the following formula.

$$ATT = 20\text{Log} \left(\frac{\text{Pin 1(Pin 3) AC voltage at V1 = 3 V}}{\text{Pin 1(Pin 3) AC voltage at V1 = 0 V}} \right)$$

- 3) Current of the charge and discharge to the Condenser Pin.
 - Current of the charge.
When the control is 'Hi' and the measurement is outflow current 'A2' when the Pin 4 voltage is 0.3 V.
 - Current of the discharge.
When the control is 'Lo (or open)' and the measurement is inflow current 'A2' when the Pin 4 voltage is 0.3 V.
- 4) Voltage of the control switch.
 - Voltage for the control 'Hi'.
The first elevates Pin 2 voltage gradually from 0 V and if its action becomes 'MUTE ON' at the Pin 1 (Pin 3) output, then measures the voltage 'V1'.
 - Voltage for the control 'Lo'.
The first lowers Pin 2 voltage gradually from VCC, and if its action becomes 'MUTE OFF' at the Pin 1 (Pin 3) output, then measures the voltage 'V1'.
- 5) Output DC voltage at the 'MUTE ON'.
When the control is 'Hi', measures the Pin 1 (Pin 3) output voltage at non-input.
- 6) Total harmonic distortion.
When the control is 'Lo (or open)', measures the distortion of the Pin 1 (Pin 3) output.
- 7) Signal Voltage Gain
When the control is 'Lo (or open)', signal gain is calculated by the following formula.

$$GV = 20\text{Log} \left(\frac{\text{Pin 1(Pin 3) AC voltage}}{\text{Pin 1(Pin 3) AC voltage front 3K}} \right)$$

- 8) Maximum input signal voltage.
When the control is 'Lo (or open)', the first elevates input AC voltage of Pin 1 (Pin 3) gradually from 0 V_{p,p}, and if the distortion became 0.01 % at the Pin 1 (Pin 3) output, the measure the AC voltage.

TYPICAL PERFORMANCE CHARACTERISTICS

$T_A = 25\text{ }^\circ\text{C}$, unless otherwise specified.

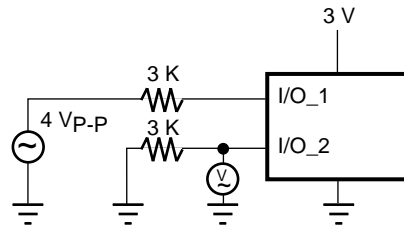
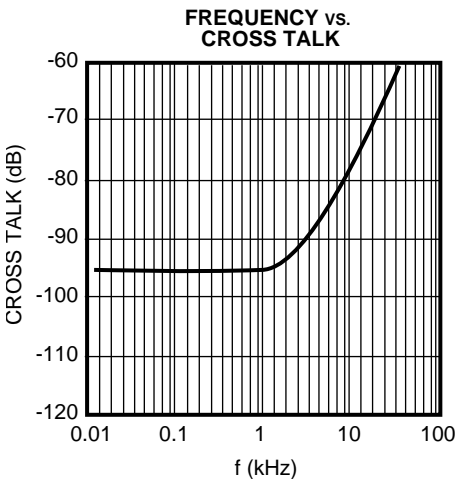
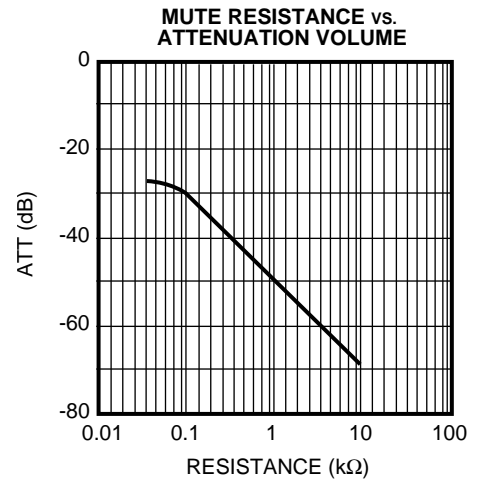
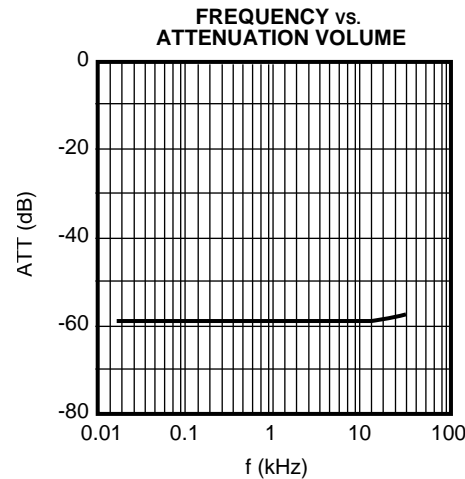
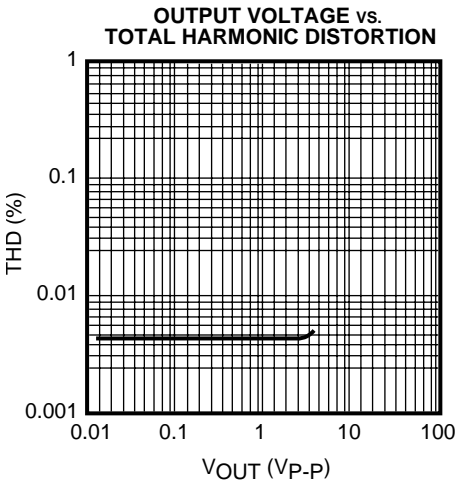
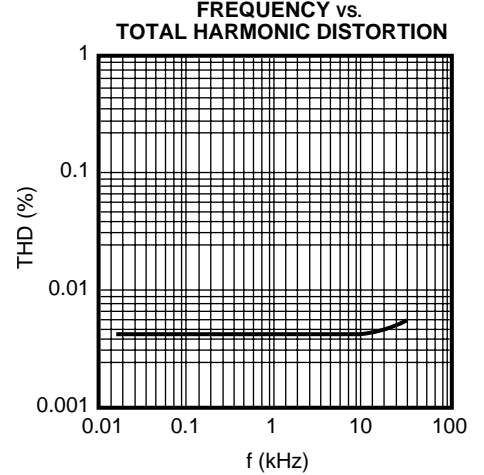
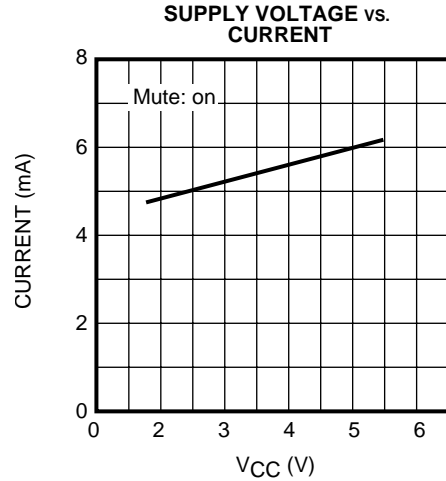
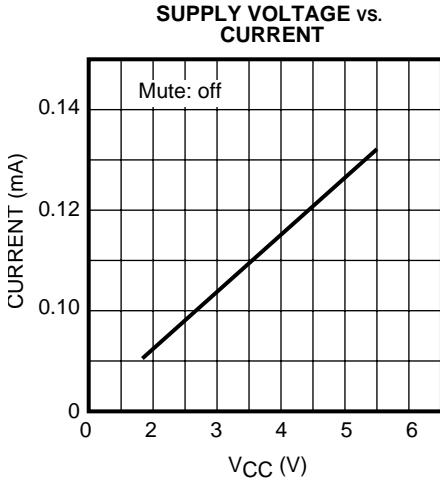

Cross Talk Test Circuit

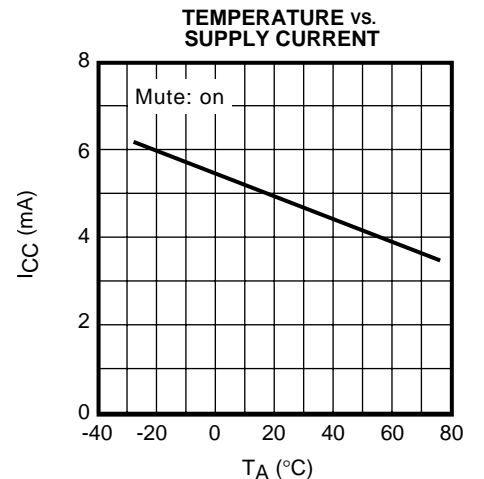

TYPICAL PERFORMANCE CHARACTERISTICS (CONT.)

$T_A = 25\text{ }^\circ\text{C}$, unless otherwise specified.

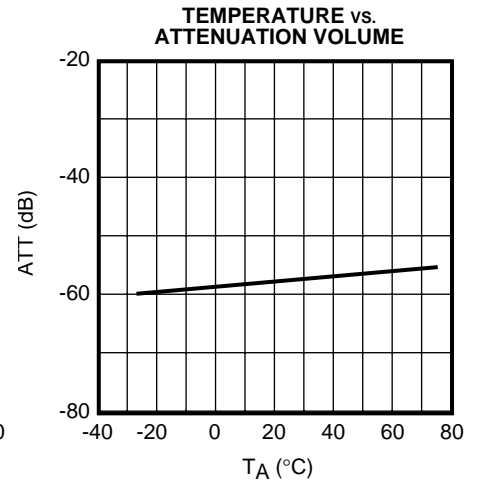
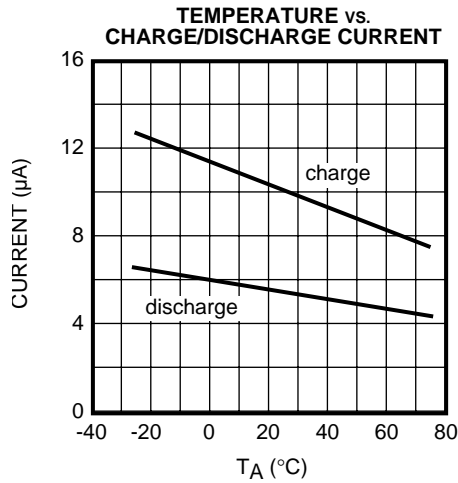
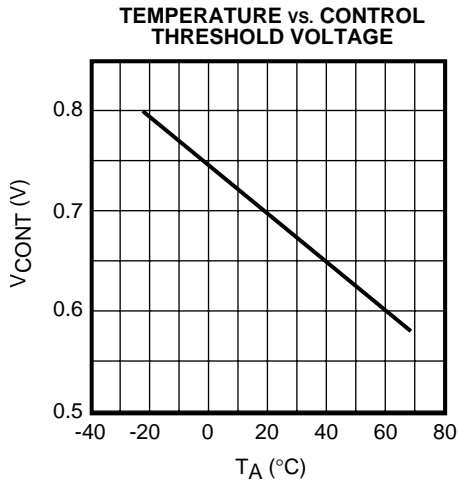

STANDARD APPLICATION

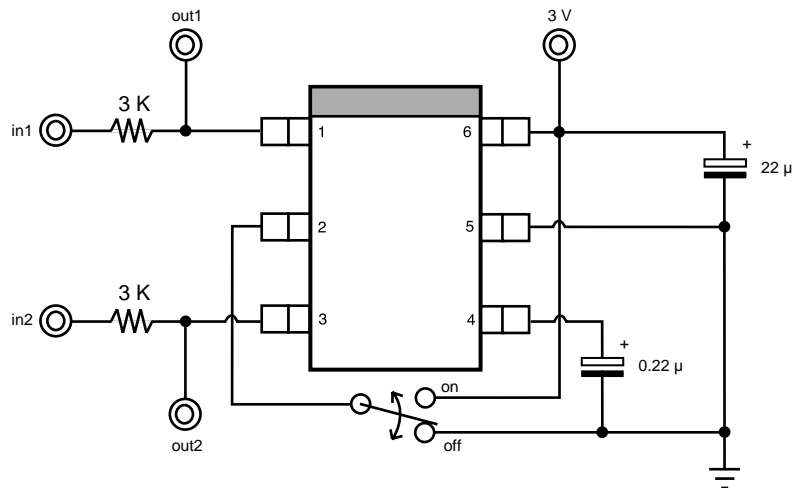

TERMINAL VOLTAGE AND EQUAL VALUE CIRCUIT

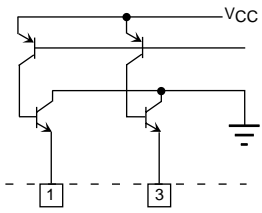
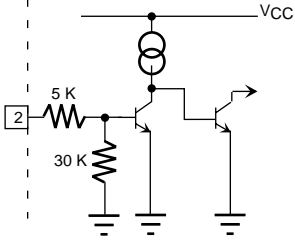
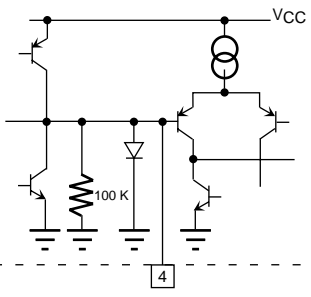
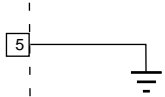
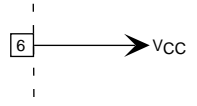
PIN NO.	SYMBOL	DC VOLTAGE	EQUAL VALUE CIRCUIT	EXPLANATION
1 3	1in/out 2in/out	Floating/0V Floating/0V		1pin: in/output for 1ch. 3pin: in/output for 2ch.
2	Control	0 V		Control Pin for the Mute on/off.
4	Mute· C	0 V/ 0.6 V		Pin for timing capacitor for attack/release action. Note 1
5	GND	0 V		Ground pin.
6	V _{CC}	1.8 ~ 5.5 V		Supply Voltage pin.

Note 1: Attack is an action that changes to 'mute on' from 'mute off', and release is an action that changes to 'mute off' from 'mute on'.
Standard capacity for the timing control is 0.22 μF.

TIMING-CHART AND ACTION TIME AT MUTE

Test conditions: $V_{CC} = 3\text{ V}$, Timing Capacitor = $0.22\ \mu\text{F}$

The following values are typical characteristics, accordingly they are not guaranteed values.

[Attack action start (mute on)]

When the mute action was attacked, the charge current starts inflow, then the voltage at the pin for the capacitor rises up to 0.6 V . The rise time to 0.6 V is the following formula.

$$T1 \approx \frac{\text{Capacity} \times 0.6\text{ V}}{\text{Charge Current}} = \frac{0.22\ \mu\text{F} \times 0.6\text{ V}}{10\ \mu\text{A}} = 13.2\text{ msec}$$

The voltage of Pin 4 functions to 0.6 V by the upper limit circuit. In the estimate, when the pin of capacitor is 0.15 V and between 0.16 V , the attenuation value is about 90% in the final attenuation value.

So it is the following calculation and timing chart.

$$T2 \approx \frac{0.22\ \mu\text{F} \times 0.16\text{ V}}{10\ \mu\text{A}} - \frac{0.22\ \mu\text{F} \times 0.15\text{ V}}{10\ \mu\text{A}}$$

$$= 0.22\text{ msec}$$

This time is the attack time.

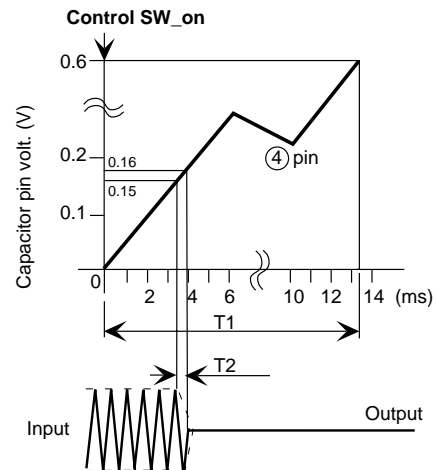

[Release action start (mute off)]

When the mute action was released, the discharge current starts outflow, then the voltage at the pin for the capacitor drops up to 10 mV . The drop time to 10 mV is the following formula.

$$T3 \approx \frac{\text{Capacity} \times 0.6\text{ V}}{\text{Discharge Current}} = \frac{0.22\ \mu\text{F} \times 0.6\text{ V}}{6\ \mu\text{A}} = 22\text{ msec}$$

In the estimate, when the pin of the capacitor is 0.16 V and between 0.15 V , the attenuation value is restored about 90% against the input value.

So it is the following calculation and timing chart.

$$T4 \approx \frac{0.22\ \mu\text{F} \times 0.16\text{ V}}{6\ \mu\text{A}} - \frac{0.22\ \mu\text{F} \times 0.15\text{ V}}{6\ \mu\text{A}}$$

$$= 0.37\text{ msec}$$

This time is the release time.

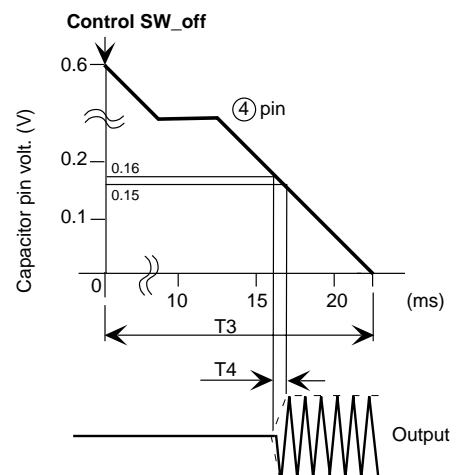

PACKAGE OUTLINE

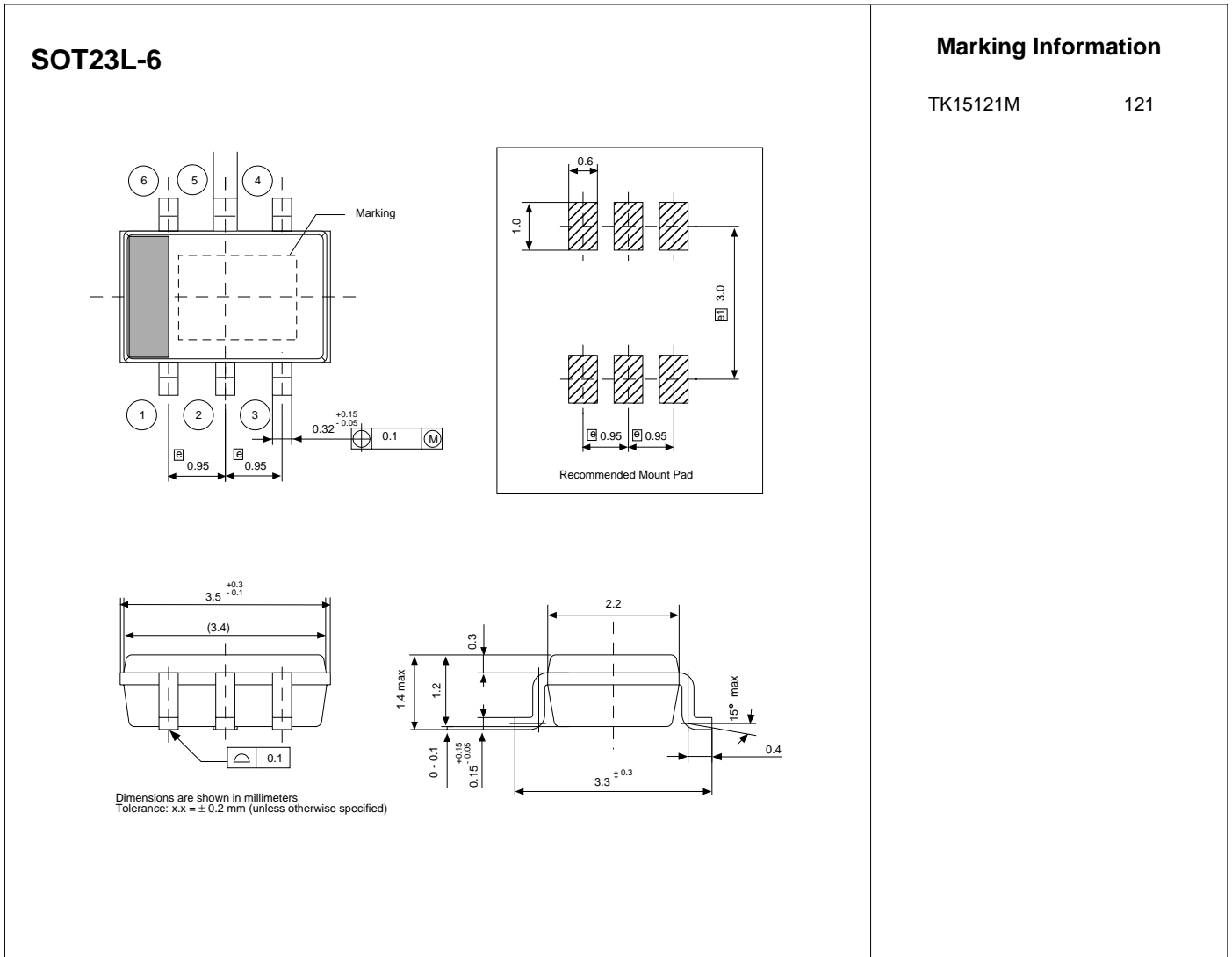

Toko America, Inc. Headquarters
 1250 Feehanville Drive, Mount Prospect, Illinois 60056
 Tel: (847) 297-0070 Fax: (847) 699-7864

TOKO AMERICA REGIONAL OFFICES

Midwest Regional Office
 Toko America, Inc.
 1250 Feehanville Drive
 Mount Prospect, IL 60056
 Tel: (847) 297-0070
 Fax: (847) 699-7864

Western Regional Office
 Toko America, Inc.
 2480 North First Street, Suite 260
 San Jose, CA 95131
 Tel: (408) 432-8281
 Fax: (408) 943-9790

Eastern Regional Office
 Toko America, Inc.
 107 Mill Plain Road
 Danbury, CT 06811
 Tel: (203) 748-6871
 Fax: (203) 797-1223

Semiconductor Technical Support
 Toko Design Center
 4755 Forge Road
 Colorado Springs, CO 80907
 Tel: (719) 528-2200
 Fax: (719) 528-2375

Visit our Internet site at <http://www.tokoam.com>

The information furnished by TOKO, Inc. is believed to be accurate and reliable. However, TOKO reserves the right to make changes or improvements in the design, specification or manufacture of its products without further notice. TOKO does not assume any liability arising from the application or use of any product or circuit described herein, nor for any infringements of patents or other rights of third parties which may result from the use of its products. No license is granted by implication or otherwise under any patent or patent rights of TOKO, Inc.