

DYNAMIC SPEAKER DRIVE AMPLIFIER

FEATURES

- Very Wide Operating Voltage ($V_{CC} = 1.8$ to 5.5 V)
- Very Low Supply Current
- Very Low Standby Current
- Miniature Package (SOT23L-6)
- Adjustable Voltage Gain ($V_{G1} = 0$ to 40 dB)
- Needs No Output Coupling Capacitor

APPLICATIONS

- Speaker Driver for Portable Equipment
- Headphone Driver
- Toys

DESCRIPTION

The TK10416M is a very low operating voltage and current audio power amplifier to drive dynamic speakers.

The TK10416M drives the speaker directly, because the device has a differential output that does not need an output coupling capacitor.

The voltage gain is adjustable by two external resistors.

The TK10416M is available in the very small SOT23L-6 surface mount package.

The small package in conjunction with few external components save printed circuit board space.

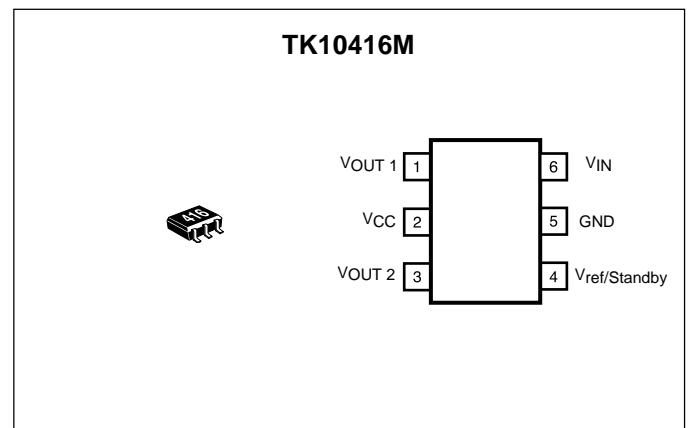

ORDERING INFORMATION

TK10416M □□

└─ Tape/Reel Code

TAPE/REEL CODE
 TL: Tape Left

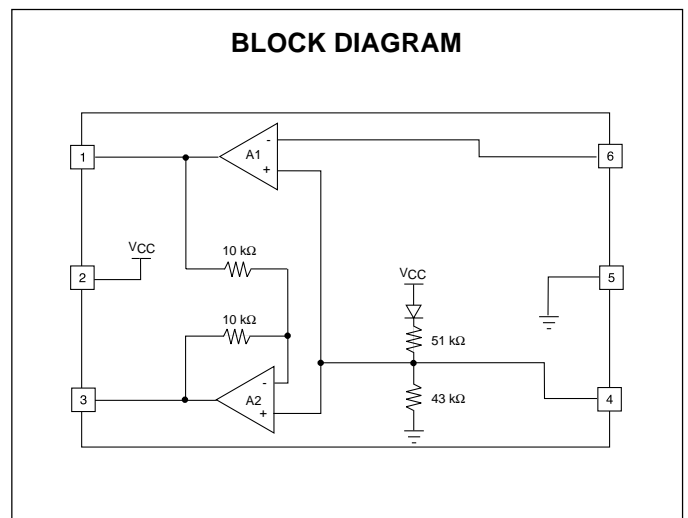

TK10416

ABSOLUTE MAXIMUM RATINGS

Supply Voltage 6 V Storage Temperature Range -55 to +150 °C
 Operating Voltage 1.8 to 5.5 V Operating Temperature Range -20 to +70 °C
 Power Dissipation (Notes 1 and 2)..... 400 mW

TK10416 ELECTRICAL CHARACTERISTICS

Test Conditions: $V_{CC} = 3.6\text{ V}$, $f = 1.0\text{ kHz}$, $R_L = 32\ \Omega$, $T_A = 25\ ^\circ\text{C}$, unless otherwise specified.

SYMBOL	PARAMETER	TEST CONDITIONS	MIN	TYP	MAX	UNITS
I_{CC}	Supply Current	$V_{CC} = 3.6\text{ V}$, $R_L = \infty$		2.7	4.0	mA
		$V_{CC} = 5.0\text{ V}$, $R_L = \infty$		2.8	4.2	mA
$I_{CC(STBY)}$	Standby Supply Current	$V_{CC} = 3.6\text{ V} = \text{Pin 4}$, $R_L = \infty$		0.0	2.0	μA
I_{CONT}	Control Terminal Current	Pin 4 Sink Current, $V_{Pin4} = V_{CC}$		90	140	μA
V_{THS}	Standby Threshold Voltage	Pin 4	$V_{CC} - 0.4$			V
G_{VO}	Open Circuit Voltage Gain	AMP1		71.0		dB
G_V	Voltage Gain	AMP1	25.0	28.0	30.0	dB
		AMP2	-3.0	0.0	+3.0	dB
		AMP1 + AMP2	31.0	34.0	36.0	dB
THD	Total Harmonic Distortion	$V_{CC} = 3.6\text{ V}$, $P_{OUT} = 60\text{ mW}$		0.5	1.0	%
		$V_{CC} = 5.0\text{ V}$, $P_{OUT} = 120\text{ mW}$		0.5	1.0	%
$P_{OUT(MAX)}$	Maximum Output Power	$V_{CC} = 3.6\text{ V}$, THD $\leq 10\%$	80	120		mW
		$V_{CC} = 5.0\text{ V}$, THD $\leq 10\%$	170	280		mW
RR	Ripple Rejection Ratio	$C_{ref} = 22\ \mu\text{F}$		42.5		dB
$V_{OUT(DC)}$	DC Voltage at Output Terminal	V_{OUT1}	1.20	1.40	1.60	V
		V_{OUT2}	1.20	1.40	1.60	V
$V_{OUT(OS)}$	Output Offset Voltage	$V_{OUT2} + V_{OUT1}$	-30.0	0.0	+30.0	mV
R_L	Load Resistance		8	32		Ω

Note 1: Power dissipation is 400 mW in free air. Derate at 3.2 mW/°C for operation above 25 °C.

Note 2: Power dissipation is 600 mW when mounted. Derate at 4.8 mW/°C for operation above 25 °C.

TEST CIRCUIT

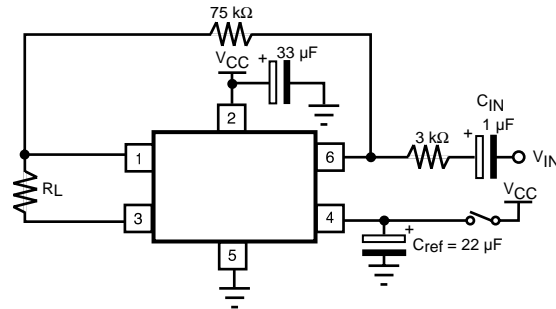

TYPICAL PERFORMANCE CHARACTERISTICS

POWER DISSIPATION vs. TEMPERATURE

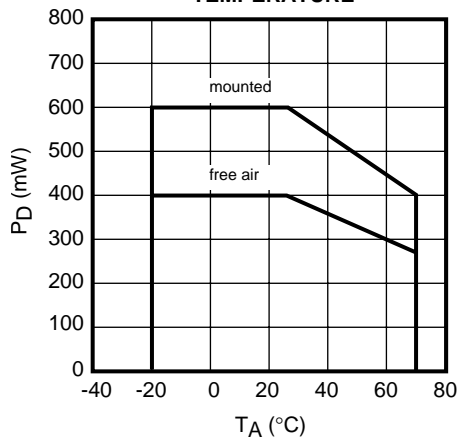

POWER DISSIPATION vs. OUTPUT POWER

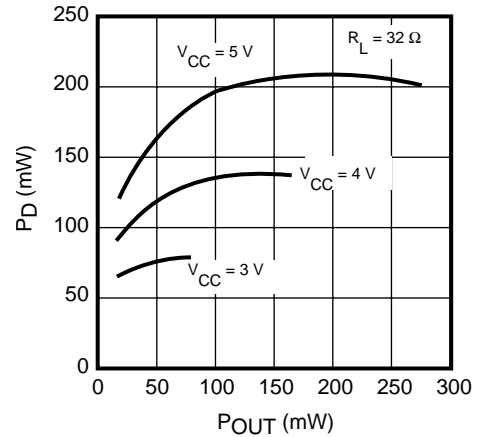

POWER DISSIPATION vs. OUTPUT POWER

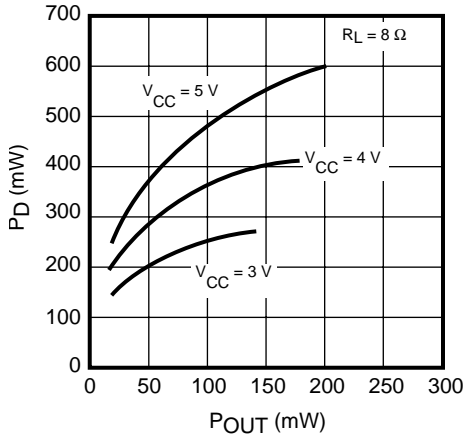

POWER DISSIPATION vs. OUTPUT POWER

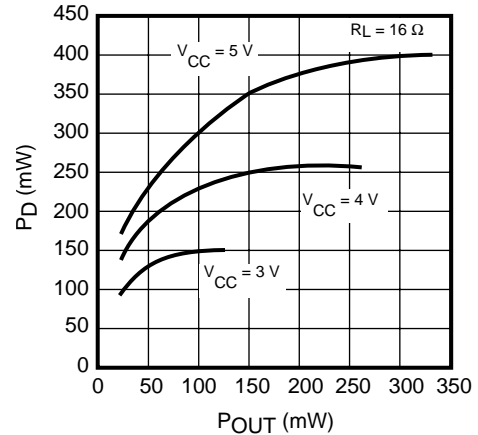

TYPICAL PERFORMANCE CHARACTERISTICS (CONT.)

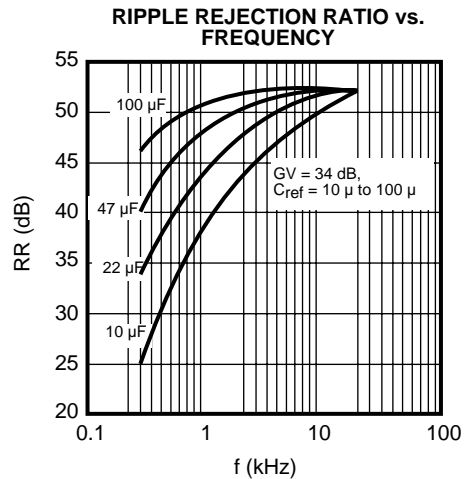
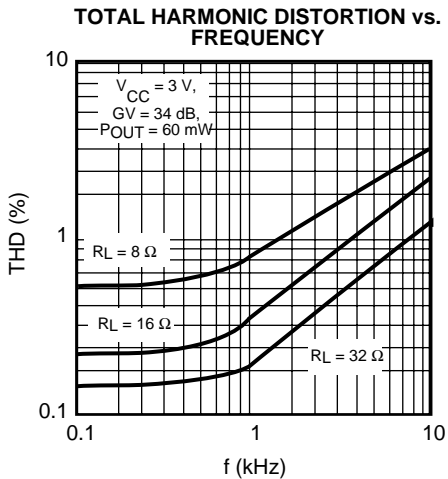
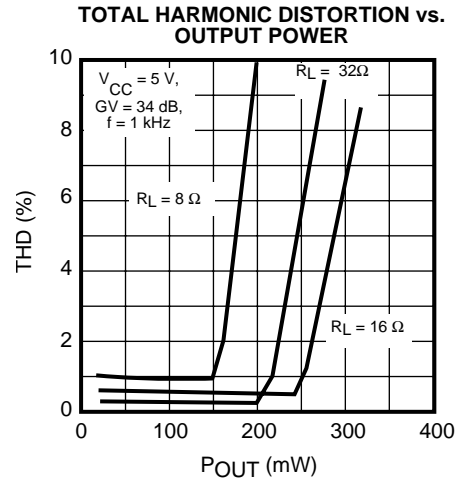
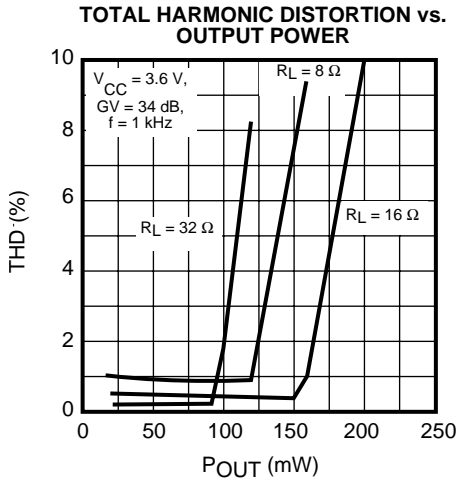
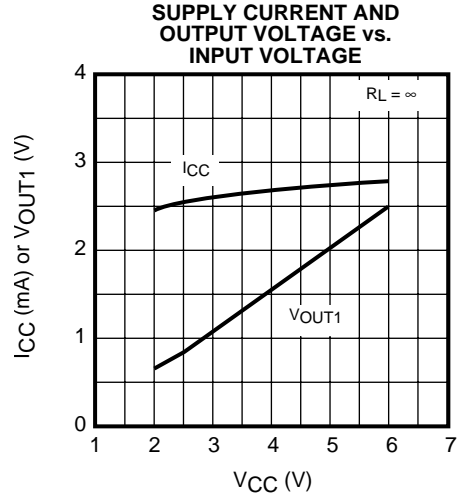
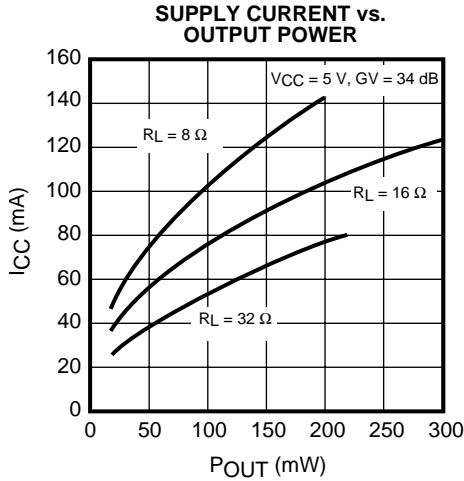

TYPICAL PERFORMANCE CHARACTERISTICS (CONT.)

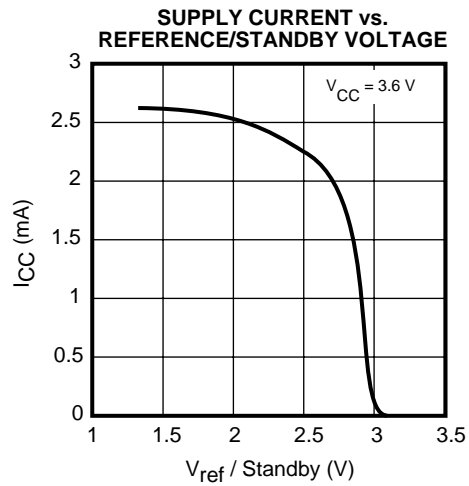
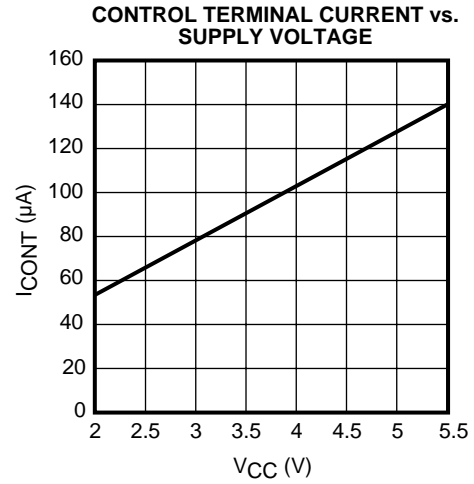
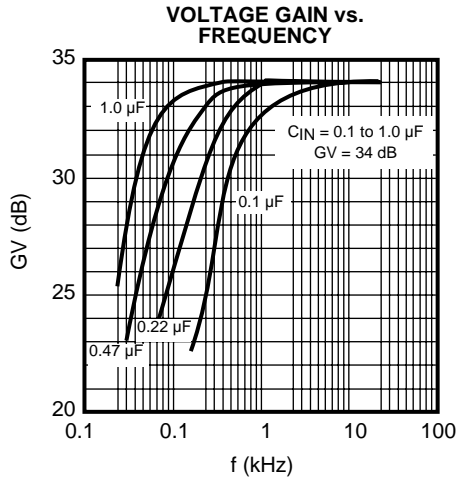

PIN FUNCTION DESCRIPTION

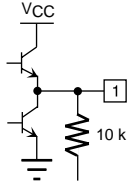
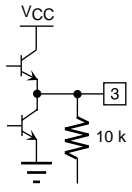
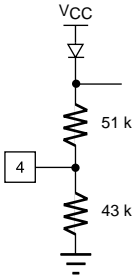
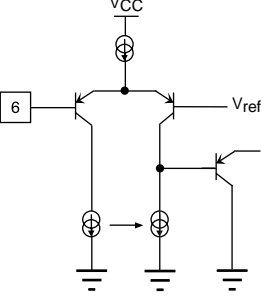
PIN NO.	SYMBOL	TERMINAL VOLTAGE (V)	INTERNAL EQUIVALENT CIRCUIT	DESCRIPTION
1	V_{OUT1}	V_{OUT} (Note 1)		A1 amplifier output terminal
2	V_{CC}	V_{CC}		Supply input terminal
3	V_{OUT2}	V_{OUT} (Note 1)		A2 amplifier output terminal
4	$V_{ref}/$ Standby	V_{OUT} (Note 1)		Reference voltage terminal. When this terminal is V_{CC} , the device is in the standby mode and the supply current is down to under 0.1 μ A.
5	GND	0 V		Ground terminal
6	V_{IN}	V_{OUT} (Note 1)		A1 amplifier input terminal

Note 1: Terminal voltage with no input signal is calculated by the following equation:

$$V_{OUT} = (V_{CC} - 0.56) \times \frac{43 \text{ k}}{43 \text{ k} + 51 \text{ k}}$$

NOTES

PACKAGE OUTLINE

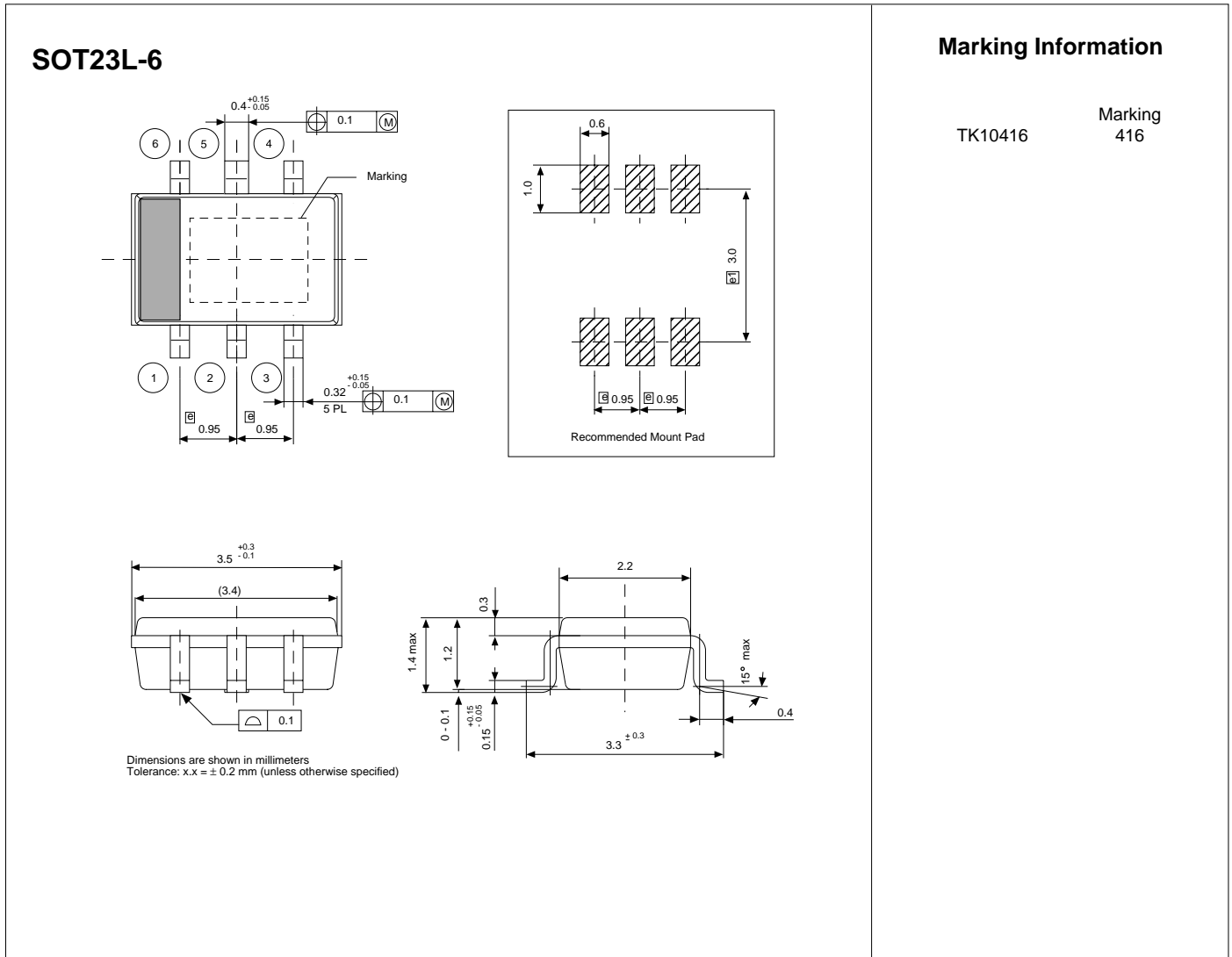

Toko America, Inc. Headquarters
1250 Feehanville Drive, Mount Prospect, Illinois 60056
Tel: (847) 297-0070 Fax: (847) 699-7864

TOKO AMERICA REGIONAL OFFICES

Midwest Regional Office
Toko America, Inc.
1250 Feehanville Drive
Mount Prospect, IL 60056
Tel: (847) 297-0070
Fax: (847) 699-7864

Western Regional Office
Toko America, Inc.
2480 North First Street, Suite 260
San Jose, CA 95131
Tel: (408) 432-8281
Fax: (408) 943-9790

Eastern Regional Office
Toko America, Inc.
107 Mill Plain Road
Danbury, CT 06811
Tel: (203) 748-6871
Fax: (203) 797-1223

Semiconductor Technical Support
Toko Design Center
4755 Forge Road
Colorado Springs, CO 80907
Tel: (719) 528-2200
Fax: (719) 528-2375

Visit our Internet site at <http://www.tokoam.com>

The information furnished by TOKO, Inc. is believed to be accurate and reliable. However, TOKO reserves the right to make changes or improvements in the design, specification or manufacture of its products without further notice. TOKO does not assume any liability arising from the application or use of any product or circuit described herein, nor for any infringements of patents or other rights of third parties which may result from the use of its products. No license is granted by implication or otherwise under any patent or patent rights of TOKO, Inc.