

FEATURES

- Miniature Package (SOT-23L-6)
- Few External Components
- Internal Rectifier and Regulator
- Wide Input Voltage Range (1.1 to 18 V)
- Selectable Output Voltages
- Single Battery Cell Operation

DESCRIPTION

The TK1181x series devices generate DC output voltages ranging from 7.2 to 32 V. Each device provides two regulated output voltages selectable by a single jumper. Designed for step-up operation, these devices will operate with an input voltage as low as 1.1 V, thus allowing single battery cell operation.

These converters have a built-in relaxation oscillator. The frequency of operation is determined by external component values. The built-in rectifier combined with an internal temperature compensated reference allows stable output voltages with minimal external components.

These devices are available in a miniature SOT-23L-6 surface mount package. An optimized surface mount inductor is available from TOKO (P/N: 395GN-0091B).

APPLICATIONS

- Variable Capacitance and PIN Diode Bias
- Portable Instrumentation
- Radio Control Systems
- Mobile Radios
- Cellular Telephones
- Cordless Telephones
- Fiber-Optic Receivers
- Local Area Network (LAN) Receivers
- Battery Operated Equipment

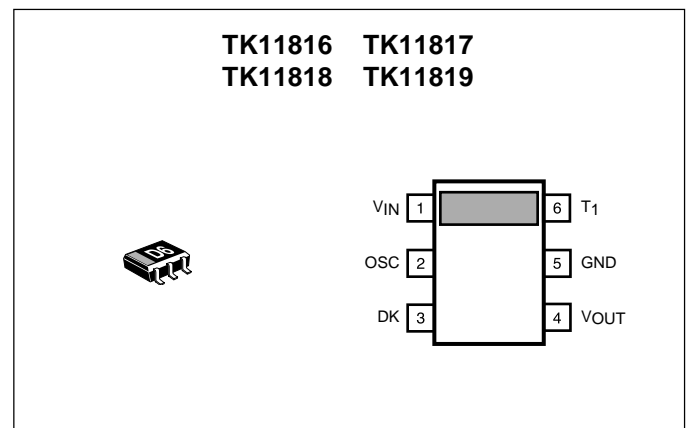

ORDERING INFORMATION	
TK11816M	□□
TK11817M	□□
TK11818M	□□
TK11819M	□□

Tape/Reel Code
TAPE/REEL CODE
TL: Tape Left

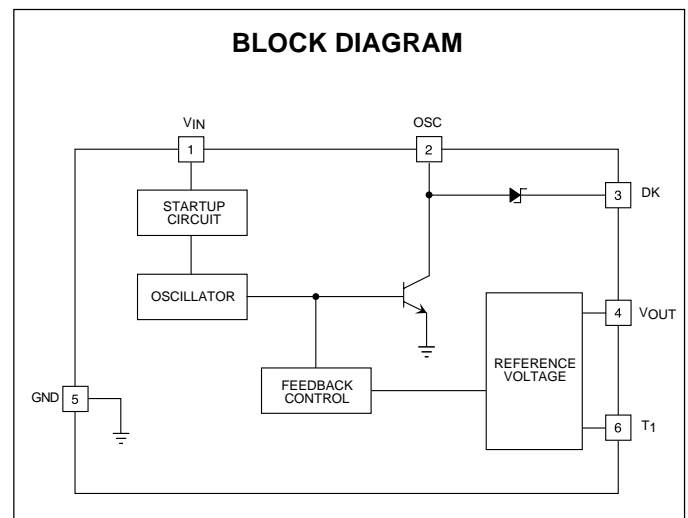

TK11816, TK11817, TK11818, TK11819

ABSOLUTE MAXIMUM RATINGS

Input Voltage	20 V	Operating Voltage Range (TK11818)	1.1 to 18 V
Power Dissipation (Note 1)	200 mW	Operating Voltage Range (TK11819)	1.1 to 18 V
Junction Temperature	150 °C	Storage Temperature Range	-55 to +150 °C
Operating Voltage Range (TK11816)	1.1 to 13 V	Operating Temperature Range	-20 to +70 °C
Operating Voltage Range (TK11817)	1.1 to 15 V	Lead Soldering Temperature (10 s)	235 °C

TK11816 ELECTRICAL CHARACTERISTICS

Test Conditions: $V_{IN} = 5\text{ V}$, $T_A = 25\text{ °C}$ (Notes 3 & 5), unless otherwise specified.

SYMBOL	PARAMETER	TEST CONDITIONS	MIN	TYP	MAX	UNITS
I_{IN}	Supply Current	$V_{OUT} = 12.8\text{ V}, I_{OUT} = 0.1\text{ mA}$		4.7	9.0	mA
		$V_{OUT} = 7.2\text{ V}, I_{OUT} = 1.0\text{ mA}$		12.1	19.0	mA
V_{OUT}	Output Voltage	$1.1\text{ V} \leq V_{IN} \leq 10\text{ V}$	12.1	12.8	13.5	V
		$1.1\text{ V} \leq V_{IN} \leq 6\text{ V}$	6.85	7.20	7.50	V
I_{OUT}	Output Current	$V_{OUT} = 12.8\text{ V}$	3.5	4.5		mA
		$V_{OUT} = 7.2\text{ V}$	4.0	6.0		mA
Load Reg	Load Regulation	(Note 4)		0.06	0.3	%
$\Delta V_{OUT}/\Delta T$	Temperature Coefficient	$V_{OUT} = 12.8\text{ V}, I_{OUT} = 0.1\text{ mA}$		1.01		mV/°C
		$V_{OUT} = 7.2\text{ V}, I_{OUT} = 0.1\text{ mA}$		2.02		mV/°C

TK11817 ELECTRICAL CHARACTERISTICS

Test Conditions: $V_{IN} = 5\text{ V}$, $T_A = 25\text{ °C}$ (Notes 3 & 5), unless otherwise specified.

SYMBOL	PARAMETER	TEST CONDITIONS	MIN	TYP	MAX	UNITS
I_{IN}	Supply Current	$V_{OUT} = 16.8\text{ V}, I_{OUT} = 0.1\text{ mA}$		4.7	9.0	mA
		$V_{OUT} = 9.3\text{ V}, I_{OUT} = 1.0\text{ mA}$		12.1	19.0	mA
V_{OUT}	Output Voltage	$1.1\text{ V} \leq V_{IN} \leq 15\text{ V}$	16.0	16.8	17.6	V
		$1.1\text{ V} \leq V_{IN} \leq 8\text{ V}$	8.85	9.30	9.80	V
I_{OUT}	Output Current	$V_{OUT} = 16.8\text{ V}$	3.5	4.5		mA
		$V_{OUT} = 9.3\text{ V}$	4.0	6.0		mA
Load Reg	Load Regulation	(Note 4)		0.06	0.3	%
$\Delta V_{OUT}/\Delta T$	Temperature Coefficient	$V_{OUT} = 16.8\text{ V}, I_{OUT} = 0.1\text{ mA}$		1.81		mV/°C
		$V_{OUT} = 9.3\text{ V}, I_{OUT} = 0.1\text{ mA}$		2.31		mV/°C

TK11818 ELECTRICAL CHARACTERISTICS

Test Conditions: $V_{IN} = 5\text{ V}$, $T_A = 25\text{ }^\circ\text{C}$ (Notes 3 & 5), unless otherwise specified.

SYMBOL	PARAMETER	TEST CONDITIONS	MIN	TYP	MAX	UNITS
I_{IN}	Supply Current	$V_{OUT} = 28\text{ V}$, $I_{OUT} = 0.1\text{ mA}$		4.7	9.0	mA
		$V_{OUT} = 20.4\text{ V}$, $I_{OUT} = 1.0\text{ mA}$		12.1	19.0	mA
V_{OUT}	Output Voltage	$1.1\text{ V} \leq V_{IN} \leq 18\text{ V}$	26.4	28.0	29.6	V
		$1.1\text{ V} \leq V_{IN} \leq 18\text{ V}$	19.3	20.4	21.5	V
I_{OUT}	Output Current	$V_{OUT} = 28\text{ V}$	1.8	3.0		mA
		$V_{OUT} = 20.4\text{ V}$	2.5	4.0		mA
Load Reg	Load Regulation	(Note 4)		0.06	0.3	%
$\Delta V_{OUT}/\Delta T$	Temperature Coefficient	$V_{OUT} = 28\text{ V}$, $I_{OUT} = 0.1\text{ mA}$		0.2		mV/ $^\circ\text{C}$
		$V_{OUT} = 20.4\text{ V}$, $I_{OUT} = 0.1\text{ mA}$		0.6		mV/ $^\circ\text{C}$

TK11819 ELECTRICAL CHARACTERISTICS

Test Conditions: $V_{IN} = 5\text{ V}$, $T_A = 25\text{ }^\circ\text{C}$ (Notes 3 & 5), unless otherwise specified.

SYMBOL	PARAMETER	TEST CONDITIONS	MIN	TYP	MAX	UNITS
I_{IN}	Supply Current	$V_{OUT} = 32\text{ V}$, $I_{OUT} = 0.1\text{ mA}$		4.7	9.0	mA
		$V_{OUT} = 24\text{ V}$, $I_{OUT} = 1.0\text{ mA}$		12.1	19.0	mA
V_{OUT}	Output Voltage	$1.1\text{ V} \leq V_{IN} \leq 18\text{ V}$	30.0	32.0	34.0	V
		$1.1\text{ V} \leq V_{IN} \leq 18\text{ V}$	22.5	24.0	25.5	V
I_{OUT}	Output Current	$V_{OUT} = 32\text{ V}$	1.8	3.0		mA
		$V_{OUT} = 24\text{ V}$	2.5	4.0		mA
Load Reg	Load Regulation	(Note 4)		0.06	0.3	%
$\Delta V_{OUT}/\Delta T$	Temperature Coefficient	$V_{OUT} = 32\text{ V}$, $I_{OUT} = 0.1\text{ mA}$		0.91		mV/ $^\circ\text{C}$
		$V_{OUT} = 24\text{ V}$, $I_{OUT} = 0.1\text{ mA}$		1.37		mV/ $^\circ\text{C}$

Note 1: Power dissipation is 400 mW when mounted. Derate at 3.2 mW/ $^\circ\text{C}$ for operation above 25 $^\circ\text{C}$. Power dissipation is 200 mW in free air. Derate at 1.6 mW/ $^\circ\text{C}$ for operation above 25 $^\circ\text{C}$.

Note 2: When operating below 25 $^\circ\text{C}$, the output capacitor degradation may increase output ripple noise.

Note 3: $V_{IN} = 5.0\text{ V}$, No load.

Note 4: Load Regulation = $(\Delta V_{OUT} / V_{OUT}) \times 100\%$, where $\Delta V_{OUT} = V_{OUT}(\text{no load}) - V_{OUT}(I_{OUT} = 1.0\text{ mA})$

Note 5: Specifications are based upon a Toko 395GN-0091IB inductor. The use of other inductors may degrade performance.

Note 6: See Output Voltage Selection Table for connections to obtain desired output voltage.

TK11816, TK11817, TK11818, TK11819

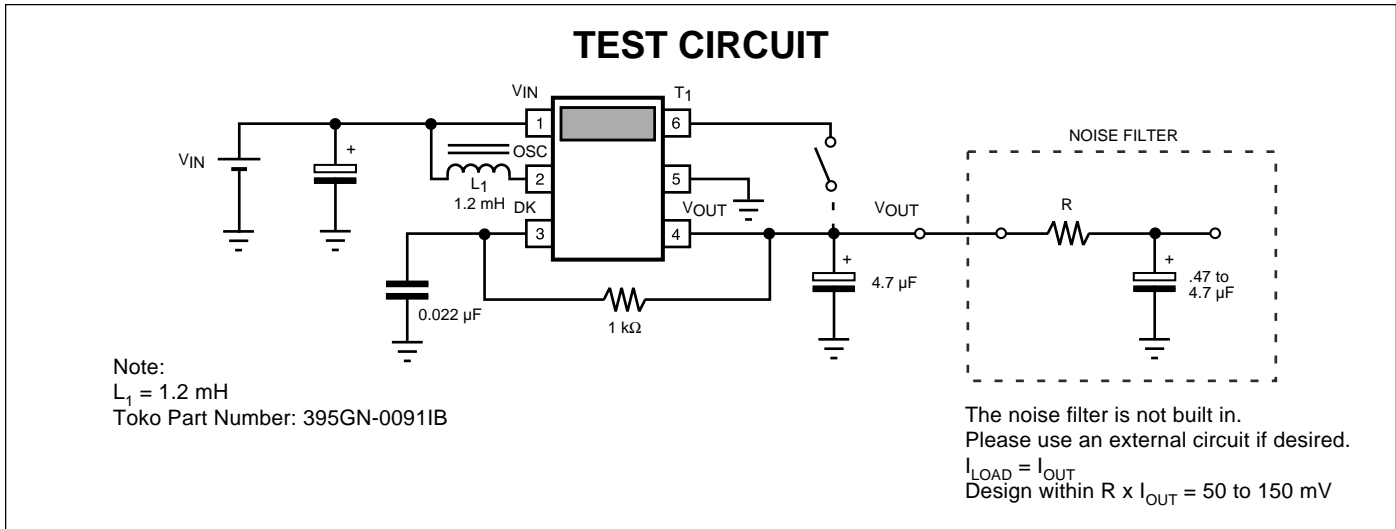

OUTPUT VOLTAGE SELECTION

PART NUMBER	MARKING	OUTPUT VOLTAGE	
		$V_{OUT} - T_1$ (OPEN)	$V_{OUT} - T_1$ (JUMPERED)
TK11816	D6	12.8 V	7.2 V
TK11817	D7	16.8 V	9.3 V
TK11818	D8	28.0 V	20.4 V
TK11819	D9	32.0 V	24.0 V

TYPICAL PERFORMANCE CHARACTERISTICS

$T_A = 25\text{ }^\circ\text{C}$, unless otherwise specified.

TK11816 ($V_{OUT} - T_1$ JUMPERED)

OUTPUT VOLTAGE vs. OUTPUT CURRENT

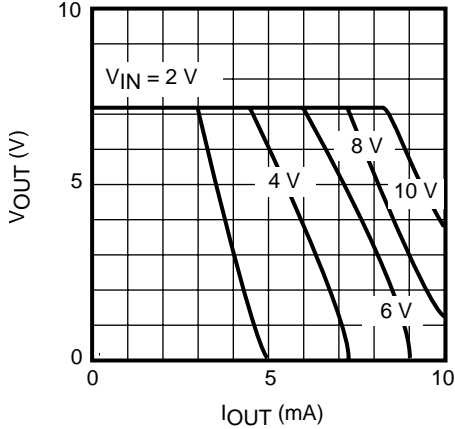

OUTPUT VOLTAGE CHANGE vs. TEMPERATURE

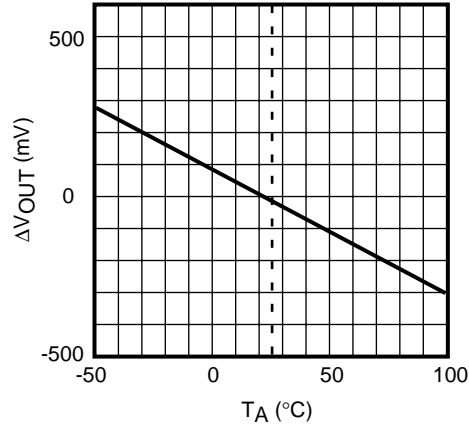

OUTPUT VOLTAGE AND SUPPLY CURRENT vs. INPUT VOLTAGE

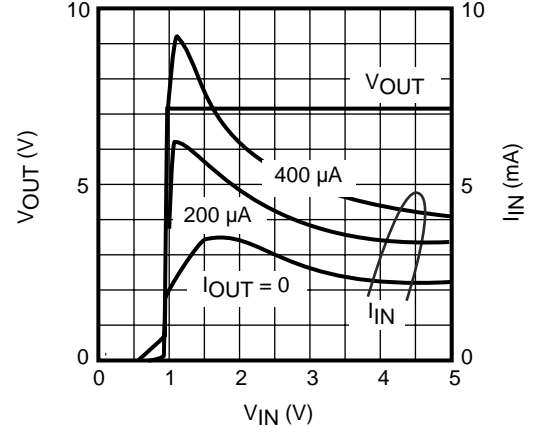

TK11816 ($V_{OUT} - T_1$ OPEN)

OUTPUT VOLTAGE vs. OUTPUT CURRENT

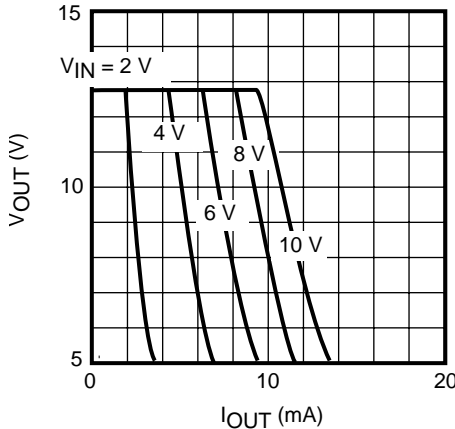

OUTPUT VOLTAGE CHANGE vs. TEMPERATURE

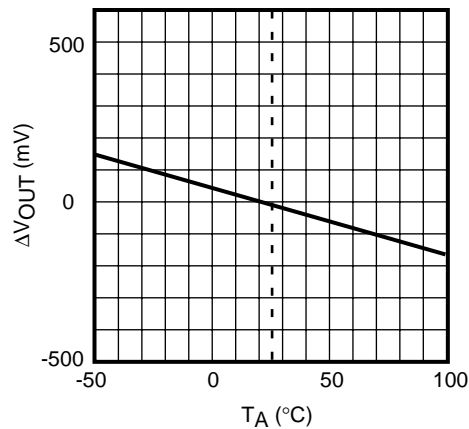

OUTPUT VOLTAGE AND SUPPLY CURRENT vs. INPUT VOLTAGE

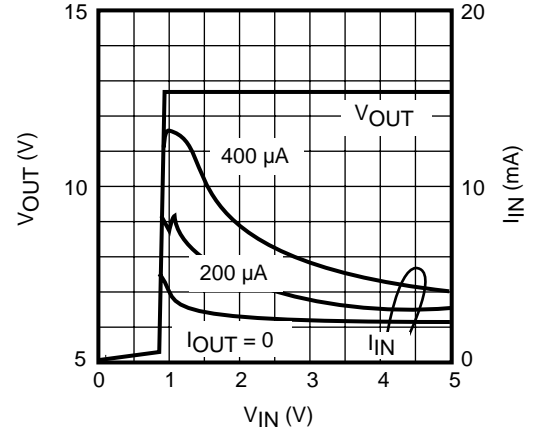

TK11817 ($V_{OUT} - T_1$ JUMPERED)

OUTPUT VOLTAGE vs. OUTPUT CURRENT

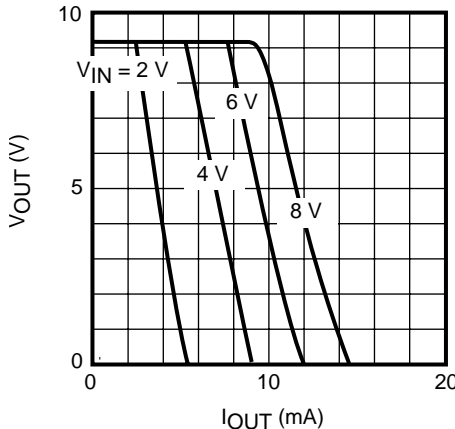

OUTPUT VOLTAGE CHANGE vs. TEMPERATURE

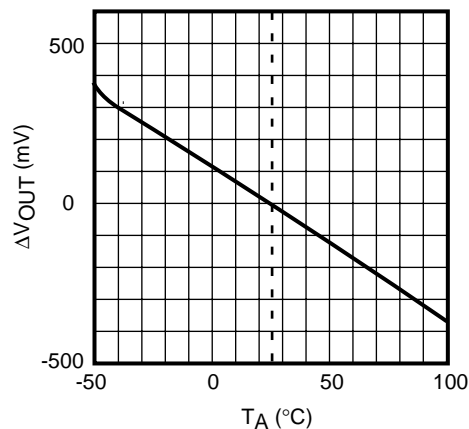

OUTPUT VOLTAGE AND SUPPLY CURRENT vs. INPUT VOLTAGE

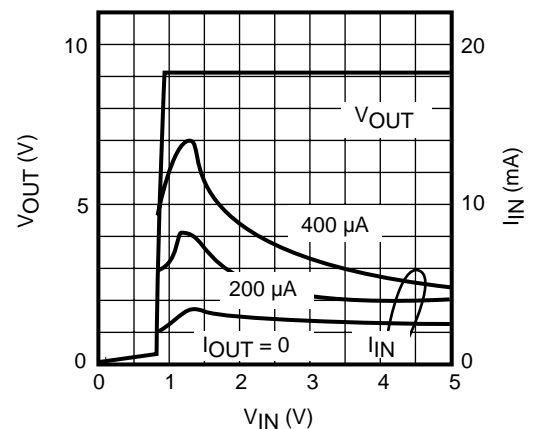

TK11816, TK11817, TK11818, TK11819

TYPICAL PERFORMANCE CHARACTERISTICS (CONT.)

$T_A = 25\text{ }^\circ\text{C}$, unless otherwise specified.

TK11817 ($V_{OUT} - T_1$ OPEN)

OUTPUT VOLTAGE vs. OUTPUT CURRENT

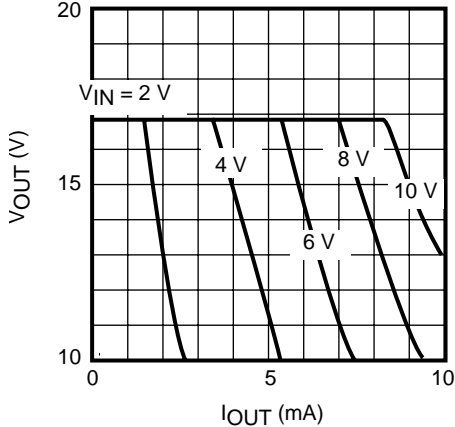

OUTPUT VOLTAGE CHANGE vs. TEMPERATURE

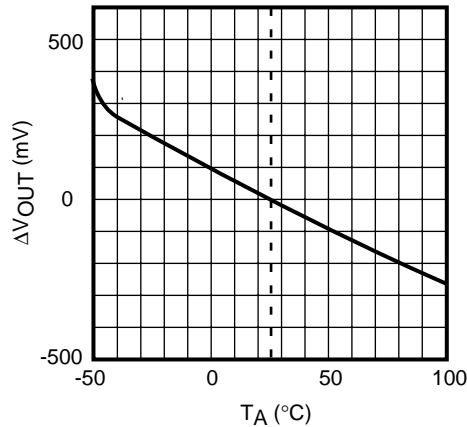

OUTPUT VOLTAGE AND SUPPLY CURRENT vs. INPUT VOLTAGE

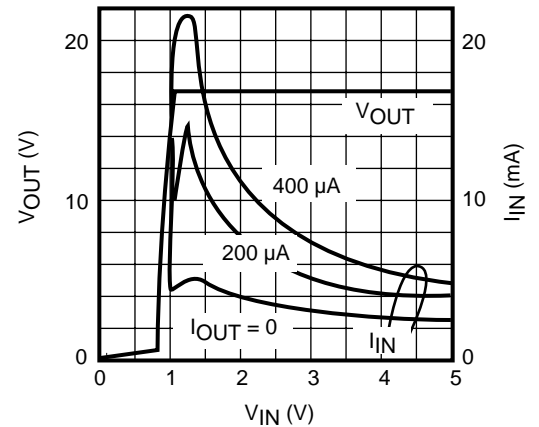

TK11818 ($V_{OUT} - T_1$ JUMPED)

OUTPUT VOLTAGE vs. OUTPUT CURRENT

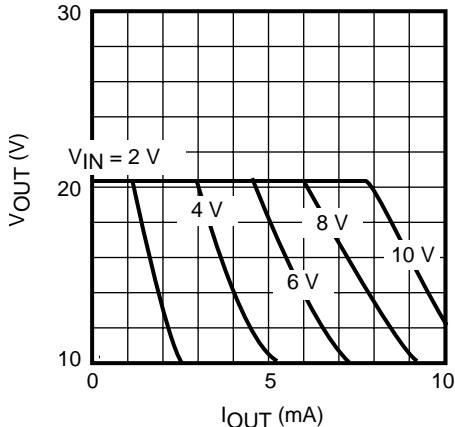

OUTPUT VOLTAGE CHANGE vs. TEMPERATURE

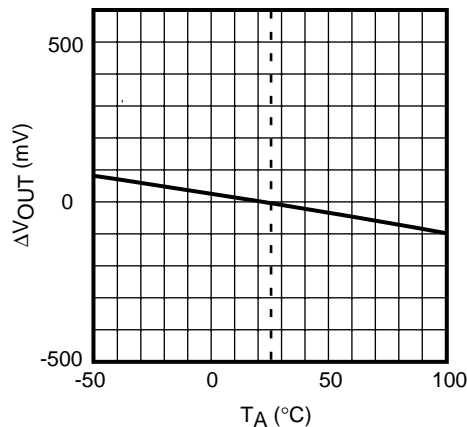

OUTPUT VOLTAGE AND SUPPLY CURRENT vs. INPUT VOLTAGE

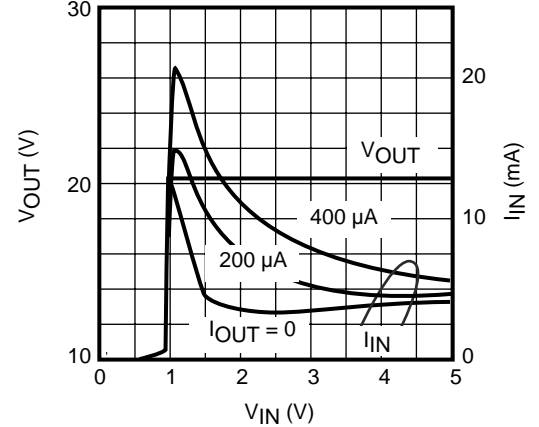

TK11818 ($V_{OUT} - T_1$ OPEN)

OUTPUT VOLTAGE vs. OUTPUT CURRENT

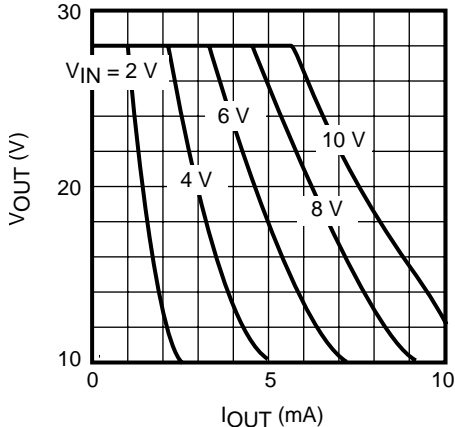

OUTPUT VOLTAGE CHANGE vs. TEMPERATURE

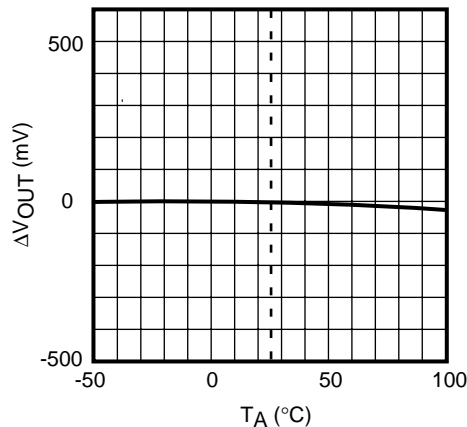

OUTPUT VOLTAGE AND SUPPLY CURRENT vs. INPUT VOLTAGE

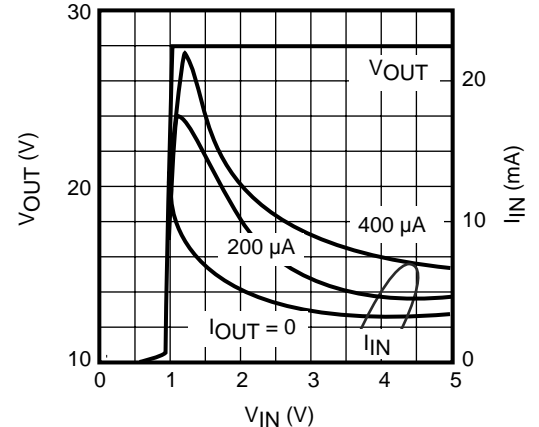

TYPICAL PERFORMANCE CHARACTERISTICS (CONT.)

$T_A = 25\text{ }^\circ\text{C}$, unless otherwise specified.

TK11819 ($V_{OUT} - T_1$ JUMPERED)

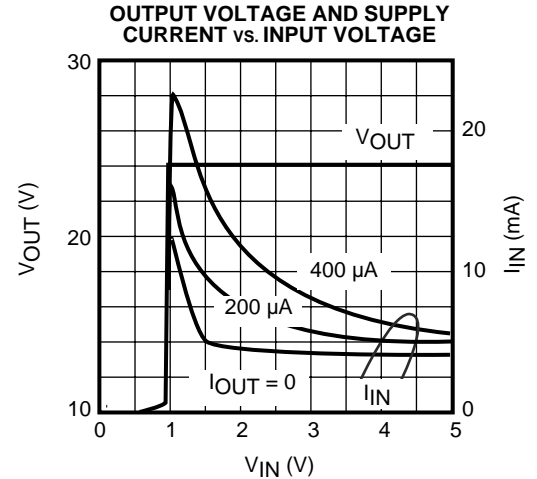
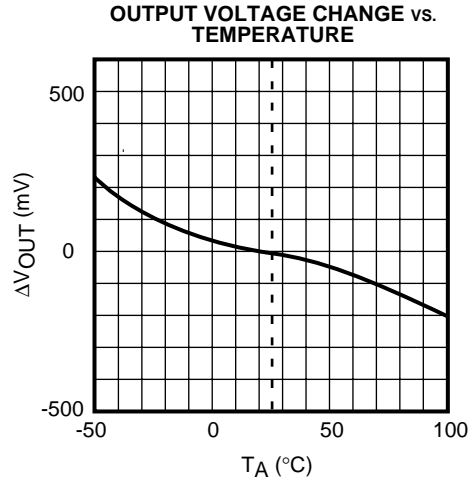
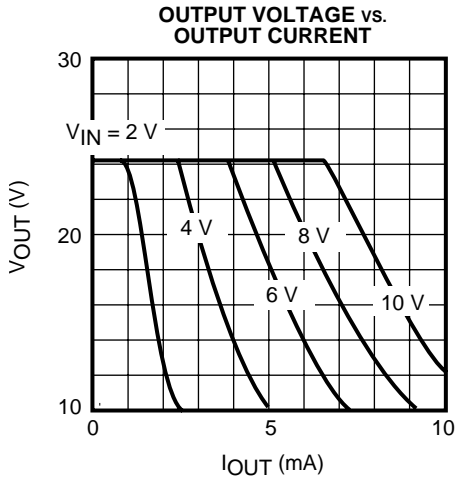

TK11819 ($V_{OUT} - T_1$ OPEN)

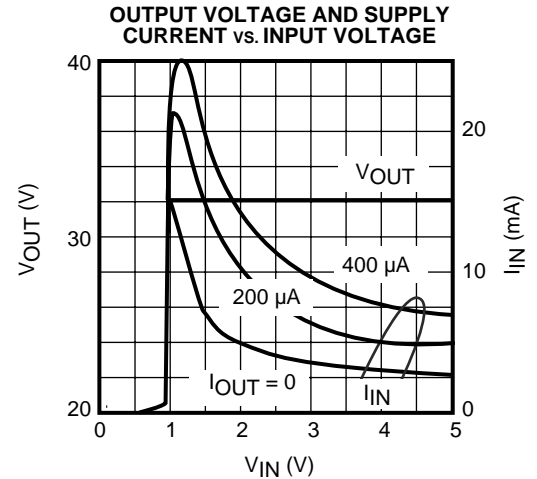
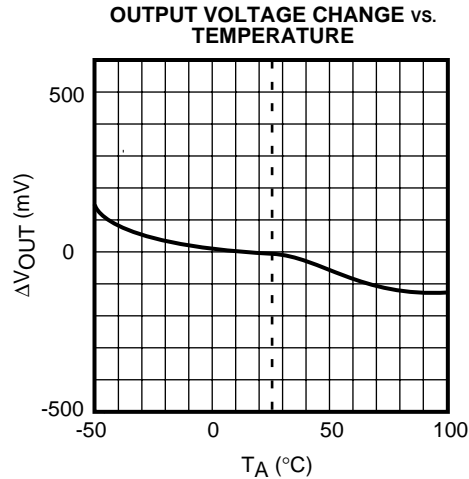
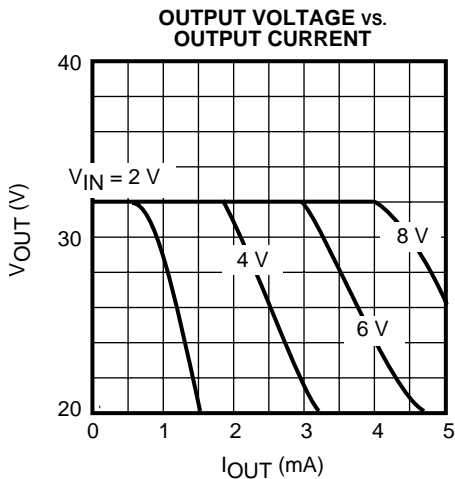

APPLICATION INFORMATION

HANDLING MOLDED RESIN PACKAGES

All plastic molded packages absorb some moisture from the air. If moisture absorption occurs prior to soldering the device onto the printed circuit board, increased separation of the lead from the plastic molding may occur, degrading the moisture barrier characteristics of the device. This property of plastic molding compounds should not be overlooked, particularly in the case of very small packages, where the plastic is very thin. In order to preserve the original moisture barrier properties of the package, devices are stored and shipped in moisture proof bags, filled with dry air. The bags should not be opened or damaged prior to the actual use of the devices. If this is unavoidable, the devices should be stored in a low relative humidity environment (40 to 65%) or in an enclosed environment with desiccant.

TK11816, TK11817, TK11818, TK11819

PACKAGE OUTLINE

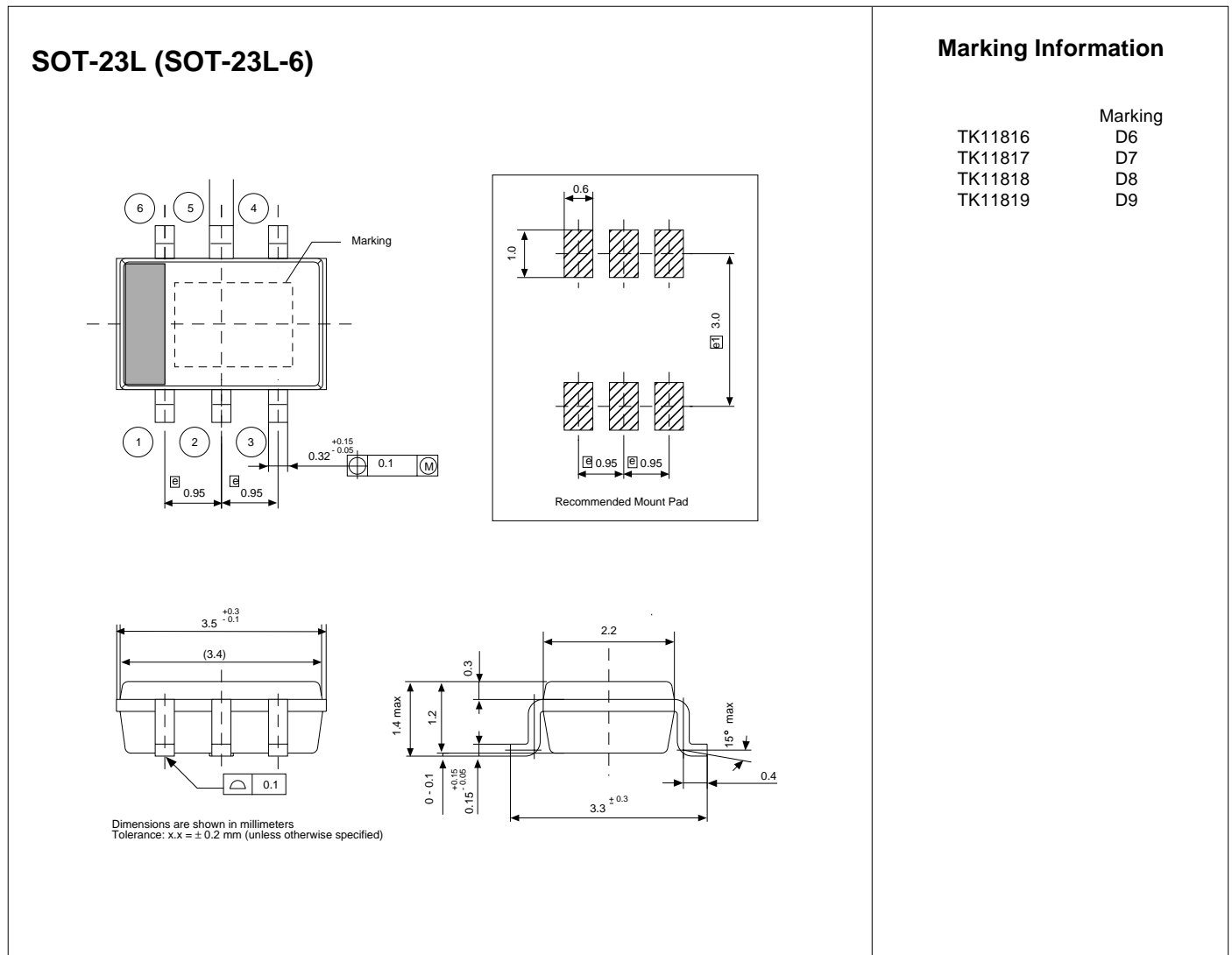

Toko America, Inc. Headquarters
 1250 Feehanville Drive, Mount Prospect, Illinois 60056
 Tel: (847) 297-0070 Fax: (847) 699-7864

TOKO AMERICA REGIONAL OFFICES

Midwest Regional Office
 Toko America, Inc.
 1250 Feehanville Drive
 Mount Prospect, IL 60056
 Tel: (847) 297-0070
 Fax: (847) 699-7864

Western Regional Office
 Toko America, Inc.
 2480 North First Street, Suite 260
 San Jose, CA 95131
 Tel: (408) 432-8281
 Fax: (408) 943-9790

Eastern Regional Office
 Toko America, Inc.
 107 Mill Plain Road
 Danbury, CT 06811
 Tel: (203) 748-6871
 Fax: (203) 797-1223

Semiconductor Technical Support
 Toko Design Center
 4755 Forge Road
 Colorado Springs, CO 80907
 Tel: (719) 528-2200
 Fax: (719) 528-2375

Visit our Internet site at <http://www.tokoam.com>

The information furnished by TOKO, Inc. is believed to be accurate and reliable. However, TOKO reserves the right to make changes or improvements in the design, specification or manufacture of its products without further notice. TOKO does not assume any liability arising from the application or use of any product or circuit described herein, nor for any infringements of patents or other rights of third parties which may result from the use of its products. No license is granted by implication or otherwise under any patent or patent rights of TOKO, Inc.