

TOSHIBA BIPOLAR LINEAR INTEGRATED CIRCUIT SILICON MONOLITHIC

# TA4008F

## 1.6GHz BAND BUFFER AMPLIFIER APPLICATION

### FEATURES

- Low current :  $I_{CC} = 9\text{mA}$  (Typ.)
- Recommended operating voltage :  $V_{CC} = 2.7\sim 3.3\text{V}$

### PIN ASSIGNMENT (TOP VIEW)

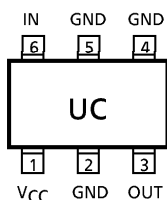

### MARKING

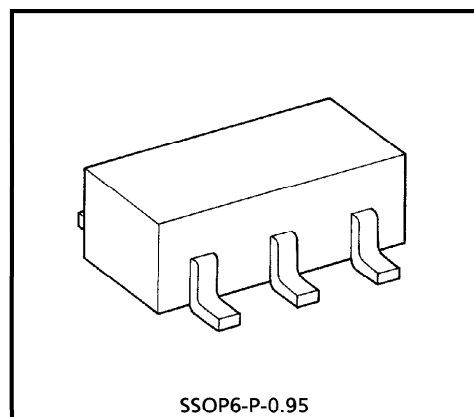
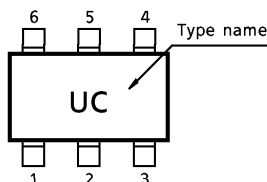

Weight : 0.014g (Typ.)

### MAXIMUM RATING (Ta = 25°C)

CHARACTERISTIC	SYMBOL	RATING	UNIT
Supply Voltage	$V_{CC}$	6	V
Total Power Dissipation	$P_D$ (*)	300	mW
Operating Temperature	$T_{opr}$	-40~85	°C
Storage Temperature Range	$T_{stg}$	-55~125	°C

(\*) When mounted on the glass epoxy board of  $2.5\text{cm}^2 \times 1.6\text{t}$ .

### TEST CIRCUIT 1

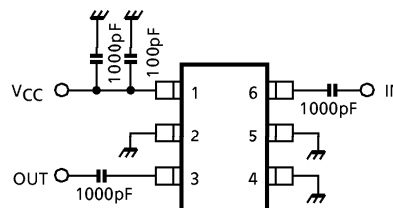

### ELECTRICAL CHARACTERISTICS ( $V_{CC} = 3\text{V}$ , $T_a = 25^\circ\text{C}$ , $Z_g = Z_l = 50\Omega$ )

CHARACTERISTIC	SYMBOL	TEST CIRCUIT	TEST CONDITION	MIN.	TYP.	MAX.	UNIT
Circuit Current	$I_{CC}$	—	Non carrier	—	9	12	mA
Frequency Range	frange	—	—	1640	—	1700	MHz
Power Gain	$G_p$	1	$f = 1640\sim 1700\text{MHz}$	8	11	14	dB
Noise Figure	NF	1		—	6	9	dB
Isolation	ISL	1		25	30	—	dB
Input VSWR	VSWR <sub>in</sub>	1		—	1.8	2.5	—
Output VSWR	VSWR <sub>out</sub>	1		—	1.9	2.5	—
Maximum Output Power	$P_o$	1		$f = 1640\sim 1700\text{MHz}$ , $P_{in} = -8\text{dBmW}$	—	-3	—

961001EBA2

● TOSHIBA is continually working to improve the quality and the reliability of its products. Nevertheless, semiconductor devices in general can malfunction or fail due to their inherent electrical sensitivity and vulnerability to physical stress. It is the responsibility of the buyer, when utilizing TOSHIBA products, to observe standards of safety, and to avoid situations in which a malfunction or failure of a TOSHIBA product could cause loss of human life, bodily injury or damage to property. In developing your designs, please ensure that TOSHIBA products are used within specified operating ranges as set forth in the most recent products specifications. Also, please keep in mind the precautions and conditions set forth in the TOSHIBA Semiconductor Reliability Handbook.

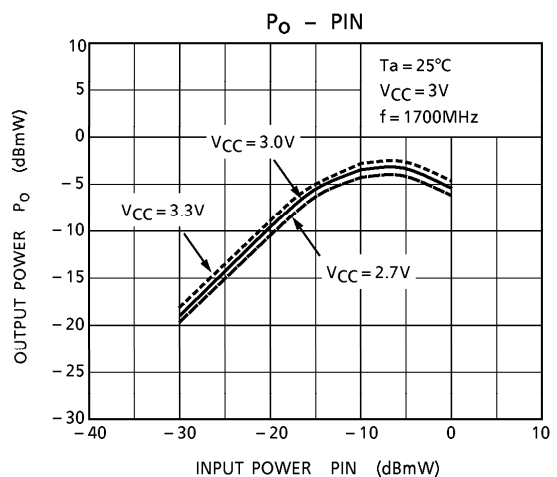
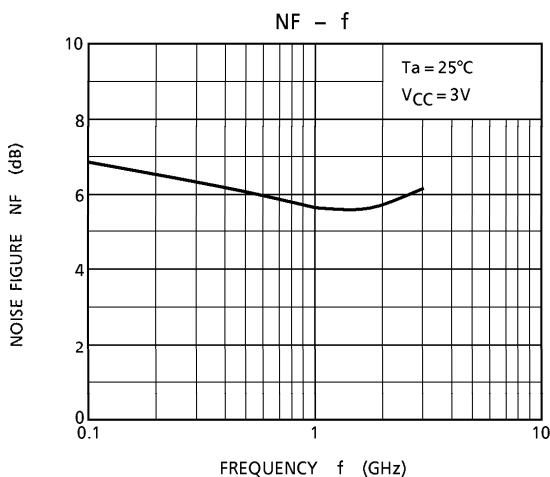
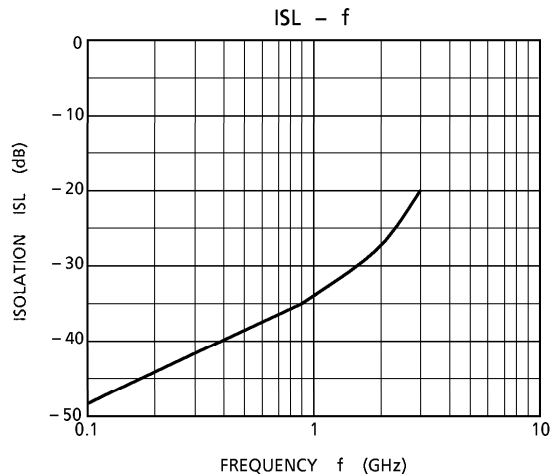
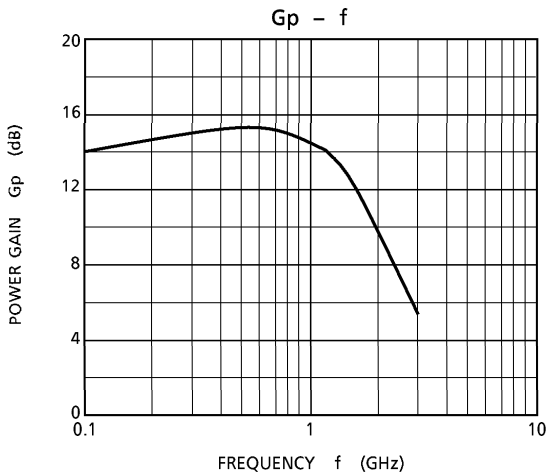
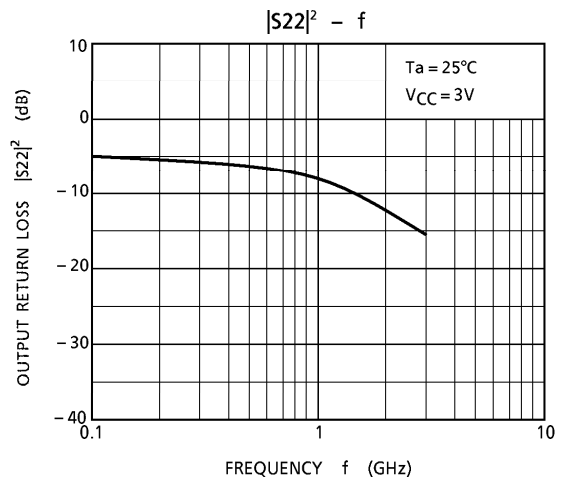
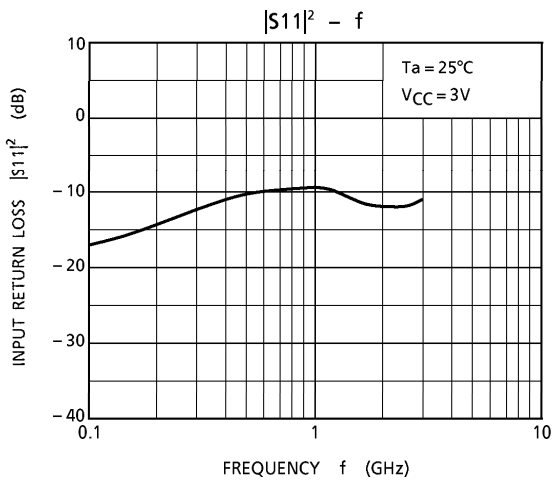

961001EBA2'

- The products described in this document are subject to foreign exchange and foreign trade control laws.
- The information contained herein is presented only as a guide for the applications of our products. No responsibility is assumed by TOSHIBA CORPORATION for any infringements of intellectual property or other rights of the third parties which may result from its use. No license is granted by implication or otherwise under any intellectual property or other rights of TOSHIBA CORPORATION or others.
- The information contained herein is subject to change without notice.

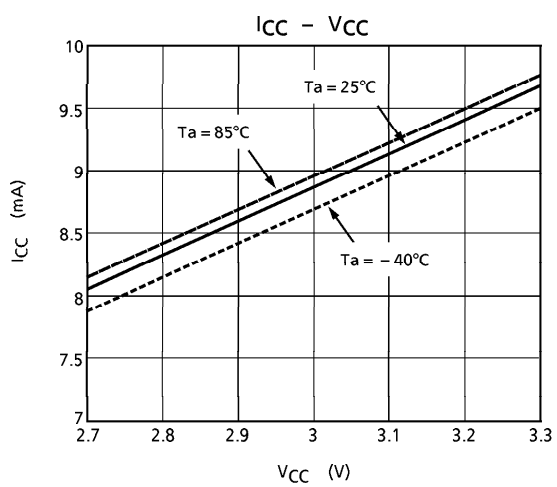

OUTLINE DRAWING  
SSOP6-P-0.95

Unit : mm

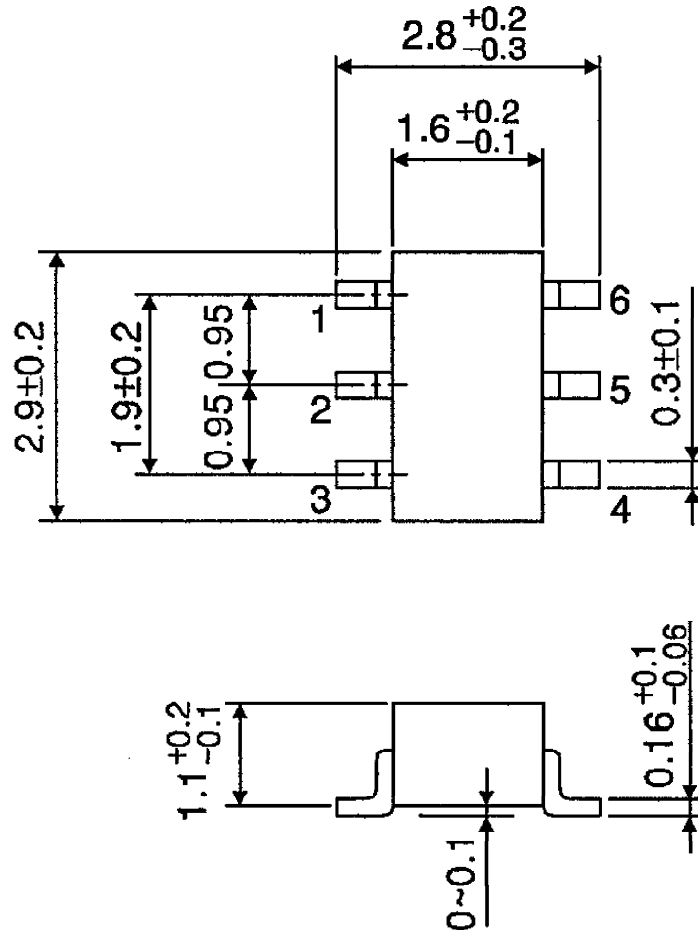

Weight : 0.014g (Typ.)