

TG2211FT

RF SPDT Switch

- Antenna switches for Bluetooth class 2 and 3
- Switch the diversity antenna
- Switch the receive filter for mobile communication
- Switch the local signal

Features

- Fewer external parts: On-chip inverter circuit
- Low insertion Loss: LOSS = 0.45dB (typ.) @1.0 GHz
= 0.55dB (typ.) @2.5 GHz
- High isolation: ISL = 25dB (typ.) @1.0 GHz
= 24dB (typ.) @2.5 GHz
- Low voltage operation: $V_{CON} = 0\text{ V}/2.7\text{ V}$
- Small package: TU6 package (mold size = $2.0 \times 1.25 \times 0.6\text{ mm}$)

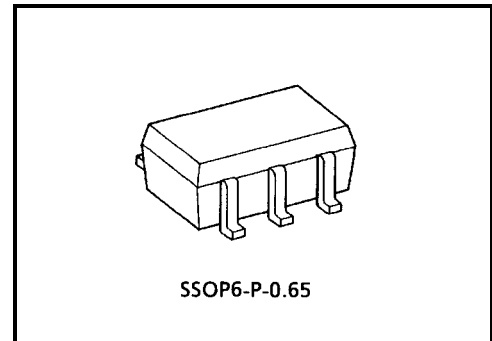

Weight: 0.008 g (typ.)

Pin Connection and Marking (top view)

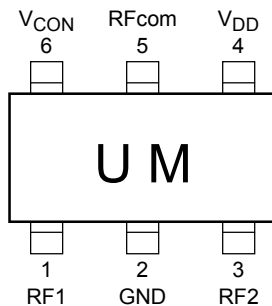

Equivalent Circuit

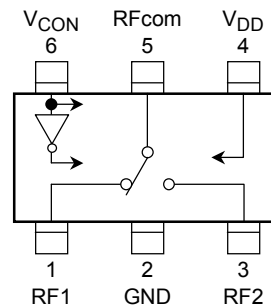

Maximum Ratings (Ta = 25°C)

Characteristics	Symbol	Rating	Unit
Supply voltage	V _{DD}	6	V
Control voltage	V _{CON}	6	V
Input power	P _i	350	mW
Operating temperature range	T _{opr}	-40~85	°C
Storage temperature range	T _{stg}	-55~125	°C

Electrical Characteristics

($V_{DD} = 2.7\text{ V}$, $V_{CON(Hi)} = 2.7\text{ V}$, $V_{CON(LO)} = 0\text{ V}$, $T_a = 25^\circ\text{C}$, $Z_g = Z_l = 50\ \Omega$)

Characteristics		Symbol	Test Circuit	Test Condition	Min	Typ.	Max	Unit
Insertion loss		LOSS (1)	1	$f = 1.0\text{ GHz}$, $P_i = 0\text{ dBmW}$	—	0.45	0.75	dB
		LOSS (2)	1	$f = 2.0\text{ GHz}$, $P_i = 0\text{ dBmW}$	—	0.5	0.8	dB
		LOSS (3)	1	$f = 2.5\text{ GHz}$, $P_i = 0\text{ dBmW}$	—	0.55	0.85	dB
Isolation	between RFcom to RF1 between RFcom to RF2	ISL (1)	1	$f = 1.0\text{ GHz}$, $P_i = 0\text{ dBmW}$	20	25	—	dB
		ISL (2)	1	$f = 2.0\text{ GHz}$, $P_i = 0\text{ dBmW}$	20	25	—	dB
		ISL (3)	1	$f = 2.5\text{ GHz}$, $P_i = 0\text{ dBmW}$	20	24	—	dB
	between RF1 to RF2	ISL (4)	1	$f = 1.0\text{ GHz}$, $P_i = 0\text{ dBmW}$	20	25	—	dB
		ISL (5)	1	$f = 2.0\text{ GHz}$, $P_i = 0\text{ dBmW}$	17	20	—	dB
		ISL (6)	1	$f = 2.5\text{ GHz}$, $P_i = 0\text{ dBmW}$	14	17	—	dB
Input power at 1dB gain compression		P_{i1dB} (1)	1	$f = 1\text{ GHz}$	17	23	—	dBmW
		P_{i1dB} (2)	1	$f = 2\text{ GHz}$	17	23	—	
		P_{i1dB} (3)	1	$f = 2.5\text{ GHz}$	16	22	—	
Supply current		I_{DD}	—	When no signal	—	0.20	0.35	mA
Control current		I_{CON}	—	When no signal	—	0.03	0.05	mA
Switching time		t_{sw}	1	$f = 100\text{ MHz}$, $P_i = 0\text{ dBmW}$	—	80	200	ns

Switch Condition ($V_{DD} = Hi$)

Vcon potential	Internal connection	Rfcom – RF1	Rfcom – RF2
Hi		ON	OFF
Low		OFF	ON

Pin Description

Pin No.	Pin Symbol	Description
1	RF1	RF pin. Connect to RFcom when V_{CON} goes High. Connect a capacitor (C_1) for blocking the internal DC voltage of the IC.
2	GND	GND pin. Ground in the vicinity of this pin.
3	RF2	RF pin. Connect to RFcom when V_{CON} goes Low. Connect a capacitor (C_1) for blocking the internal DC voltage of the IC.
4	V_{DD}	Power supply pin and RF GND pin. When the device is operating, always apply the voltage of "High level" to this pin. This pin should be grounded by a capacitor (C_3) as close as possible for RF performance. The value of this capacitor affects the isolation. To protect RF signal leakage, connect a 1-k Ω resistor (R).
5	RFcom	RF pin. Connection can be switched to RF1 or RF2 by varying the level of the voltage applied to the V_{CON} pin. Connect a capacitor (C_1) for blocking the internal DC voltage of the IC.
6	V_{CON}	Voltage control pin. The switch connections can be controlled by varying the level of the voltage to this pin. Connect a bypass capacitor (C_2) to this pin.

Caution

This device is sensitive to electrostatic discharge. When using this device, please ensure that all tools and equipment are earthed.

Test Circuit 1 (RF Test Circuit)

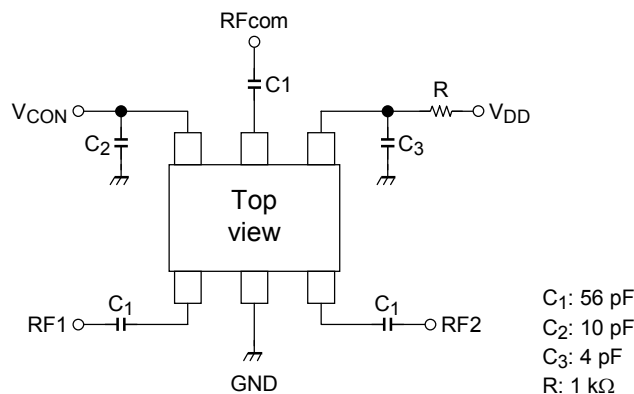

Please fix the value of each capacity for using frequency and circuit.

Reference Value of External Parts

	50~300 MHz	300~500 MHz	0.5~2.5 GHz
C_1	1000 pF	100 pF	56 pF
C_2	100 pF	10 pF	10 pF
C_3	100 pF	100 pF	4 pF
R	1 k Ω	1 k Ω	1 k Ω

Evaluation Board

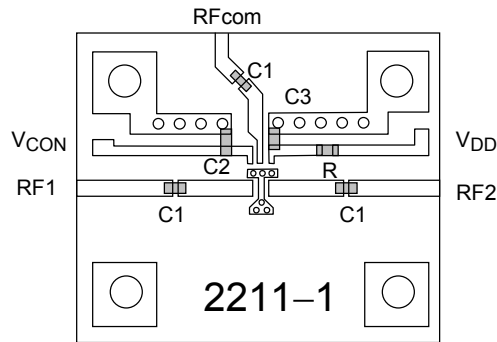

Notice

The circuits and measurements contained in this document are given only in the context of as examples of applications for these products.

Moreover, these example application circuits are not intended for mass production, since the high-frequency characteristics (the AC characteristics) of these devices will be affected by the external components which the customer uses, by the design of the circuit and by various other conditions.

It is the responsibility of the customer to design external circuits which correctly implement the intended application, and to check the characteristics of the design.

TOSHIBA assume no responsibility for the integrity of customer circuit designs or applications.

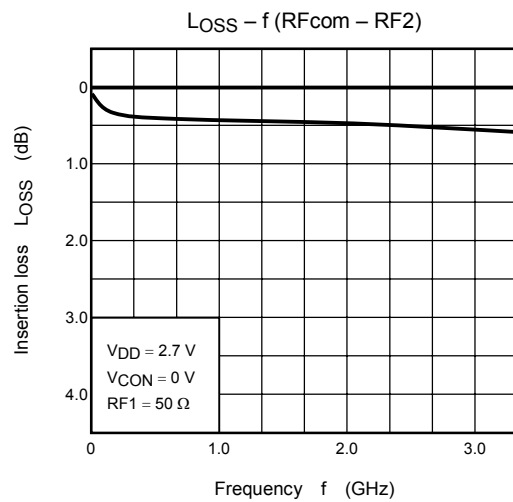
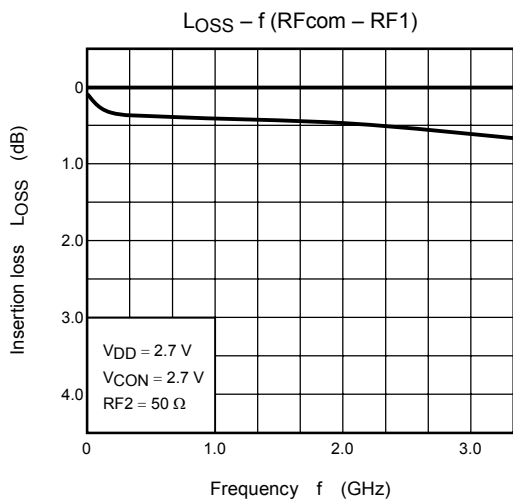
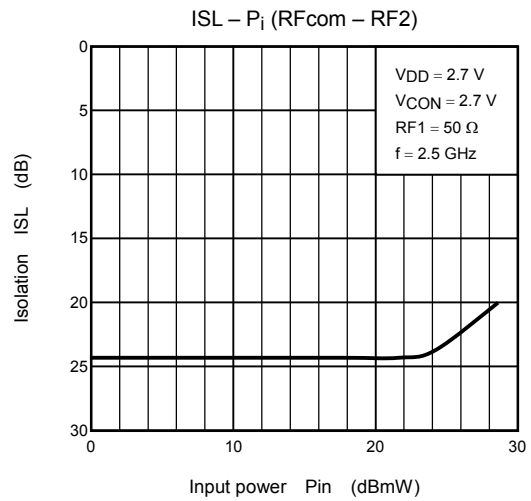
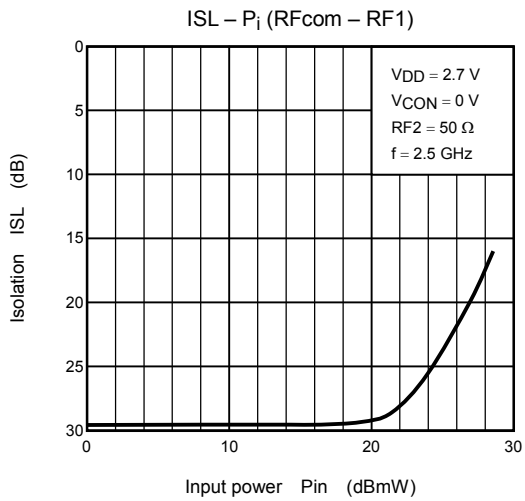
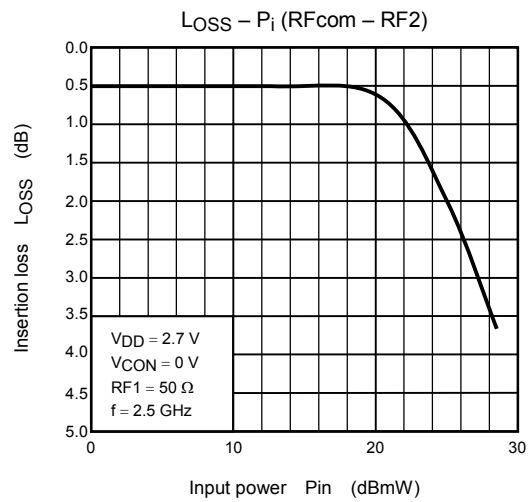
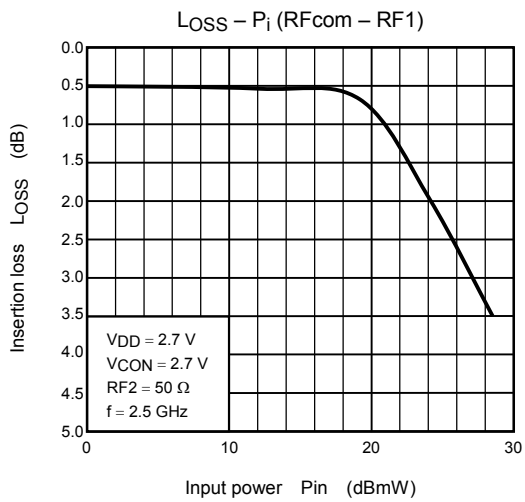

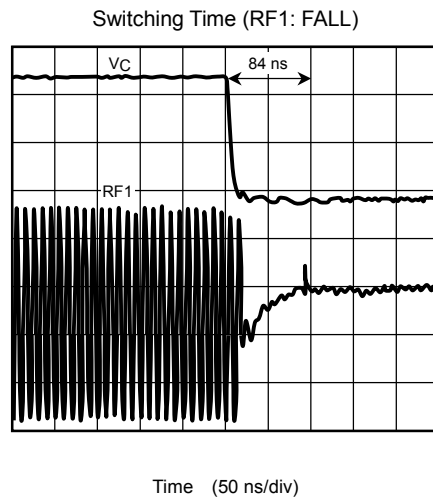
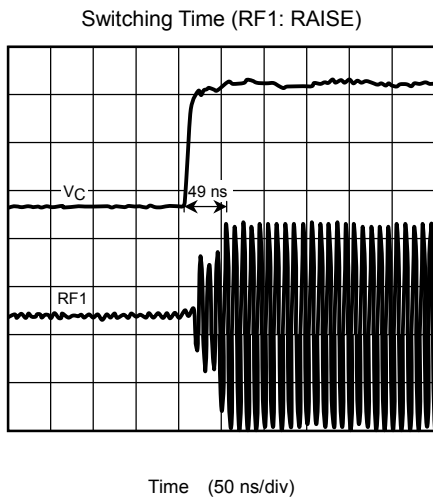
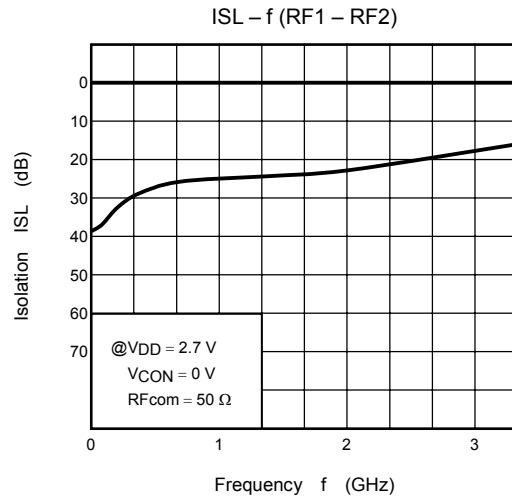
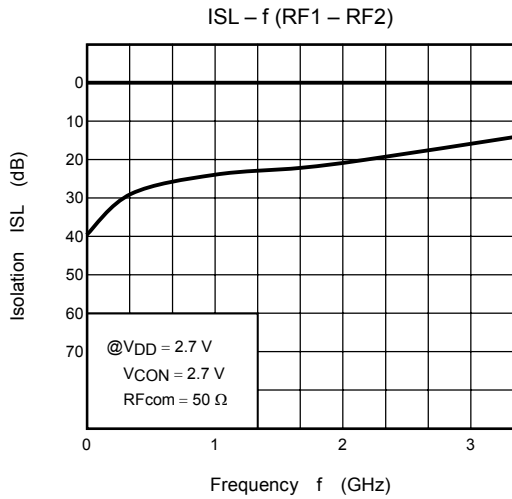
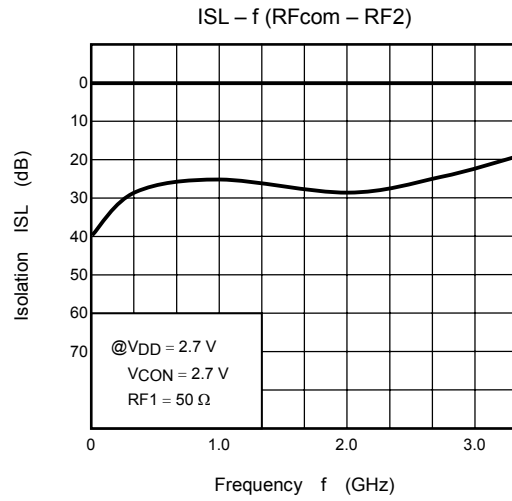
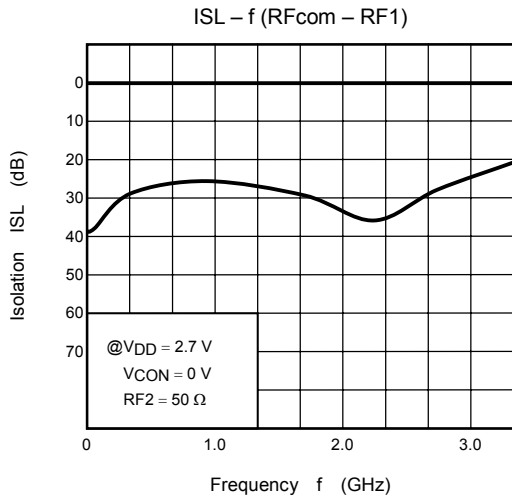

Switching Time (RF2: RAISE)

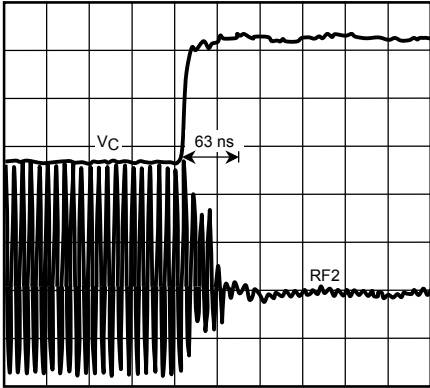

Time (50 ns/div)

Switching Time (RF2: FALL)

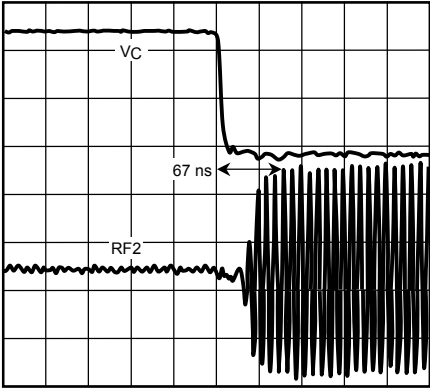

Time (50 ns/div)

Package Dimensions

SSOP6-P-0.65

Unit: mm

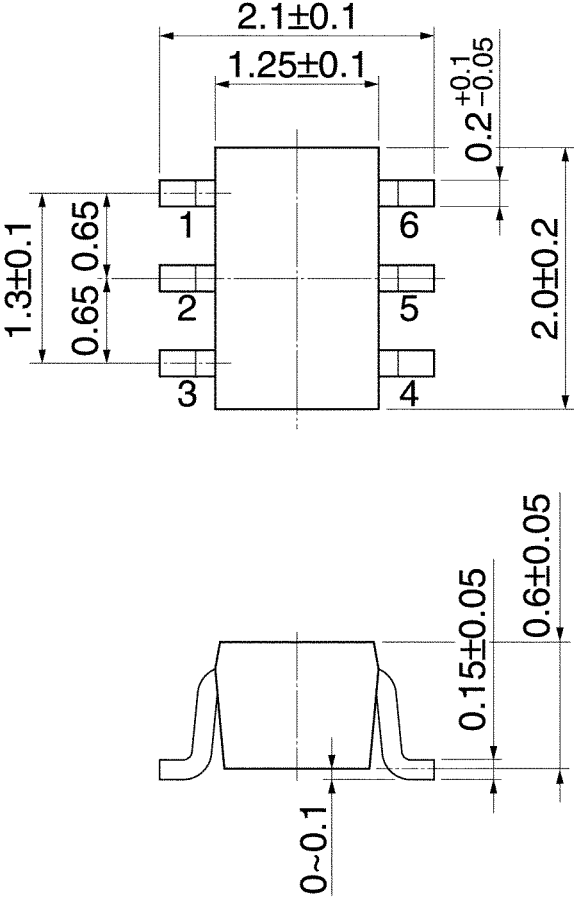

Weight: 0.008 g (typ.)

RESTRICTIONS ON PRODUCT USE

020704EAC

- TOSHIBA is continually working to improve the quality and reliability of its products. Nevertheless, semiconductor devices in general can malfunction or fail due to their inherent electrical sensitivity and vulnerability to physical stress. It is the responsibility of the buyer, when utilizing TOSHIBA products, to comply with the standards of safety in making a safe design for the entire system, and to avoid situations in which a malfunction or failure of such TOSHIBA products could cause loss of human life, bodily injury or damage to property.
In developing your designs, please ensure that TOSHIBA products are used within specified operating ranges as set forth in the most recent TOSHIBA products specifications. Also, please keep in mind the precautions and conditions set forth in the "Handling Guide for Semiconductor Devices," or "TOSHIBA Semiconductor Reliability Handbook" etc..
- The TOSHIBA products listed in this document are intended for usage in general electronics applications (computer, personal equipment, office equipment, measuring equipment, industrial robotics, domestic appliances, etc.). These TOSHIBA products are neither intended nor warranted for usage in equipment that requires extraordinarily high quality and/or reliability or a malfunction or failure of which may cause loss of human life or bodily injury ("Unintended Usage"). Unintended Usage include atomic energy control instruments, airplane or spaceship instruments, transportation instruments, traffic signal instruments, combustion control instruments, medical instruments, all types of safety devices, etc.. Unintended Usage of TOSHIBA products listed in this document shall be made at the customer's own risk.
- Gallium Arsenide (GaAs) is a substance used in the products described in this document. GaAs dust or vapor is harmful to the human body. Do not break , cut, crush or dissolve chemically.
- The information contained herein is presented only as a guide for the applications of our products. No responsibility is assumed by TOSHIBA CORPORATION for any infringements of intellectual property or other rights of the third parties which may result from its use. No license is granted by implication or otherwise under any intellectual property or other rights of TOSHIBA CORPORATION or others.
- The information contained herein is subject to change without notice.