

IC DATA SHEET



DUAL LDO REGULATOR WITH ON/OFF SWITCH
TK740xxL

TK740xxL**Dual Low DropOut regulator with independent on/off switches****Features**

- 2Ch Low Drop-Out regulator built into one package
- Independent on/off Switch for each LDO regulator (high on)
- Ability to set out put voltage by external resistors
- Wide operating voltage range (1.8V ~ 14.5V)
- Very good Ripple Rejection Ratio (84dB)
- Very small Drop Out Voltage Side A 90mV / 100mA : 160mV /200mA
Side B 80mV / 50mA : 135mV / 100mA
(A side // B side) :Vdrop=70mV/100mA : 125mV/200mA : 180mV/300mA
- Very small quiescent current (45 μ A /ch)
- High output voltage accuracy (± 60 mV or $\pm 2.0\%$ Iout = 5mA 1.3V ~ 5.0V)
- Low value output capacitor requirements for stability (CL_{min} =0.1 μ F)
- Operates with Low ESR ceramic capacitors in most applications
- Built-in reverse bias voltage protection. Built-in thermal / short circuit current protection.
- Wide operating ambient temperature range (-40 to +85)
- SOT23L 8-pin surface mount package

Description

The TK740xxL is an integrated circuit with a silicon monolithic bipolar structure. The regulator is of the low saturation voltage output type with very little quiescent current (45 μ A/ch)

The TK740xx Dual Ultra Low-Drop-Out regulator operates from a 1.8V to 14.5V input supply voltage range. The A- Side delivers up to 200mA output current and the B-Side delivers up to 120mA output current over the full temperature range.

The TK740xx features very high stability in both DC and AC. The capacitor on the output side provides stable operation with 0.1 μ F with 1.8V Vout. A capacitor of any type can be used; however, the larger this capacitor is, the better the overall characteristics are.

The TK740xx makes it very suitable for portable and battery powered applications. TK740xx has independent on/off control functions. The internal switches can each be controlled by electric levels.

The device is in the ON State when the control pin is pulled to a logic high level. An internal PNP pass transistor is used to achieve a low dropout voltage of 90mV (typ.) at 50mA load current. The TK740xx has an exceptionally low quiescent current of 45 μ A at no load and 0.4mA with a 50mA load. The standby current is typically 100pA. The internal thermal shutdown circuitry limits the junction temperature to below 150 . The load current is internally monitored and the device will be shutdown by a short circuit or excessive current condition at the output. The TK740xxL provides low noise performance by using the external noise bypass capacitor Cfb. The output voltage can be changed by using external resistors. A special good point is the ripple rejection ratio. A value of 80dB at 1kHz and 83dB at 400Hz can be obtained.

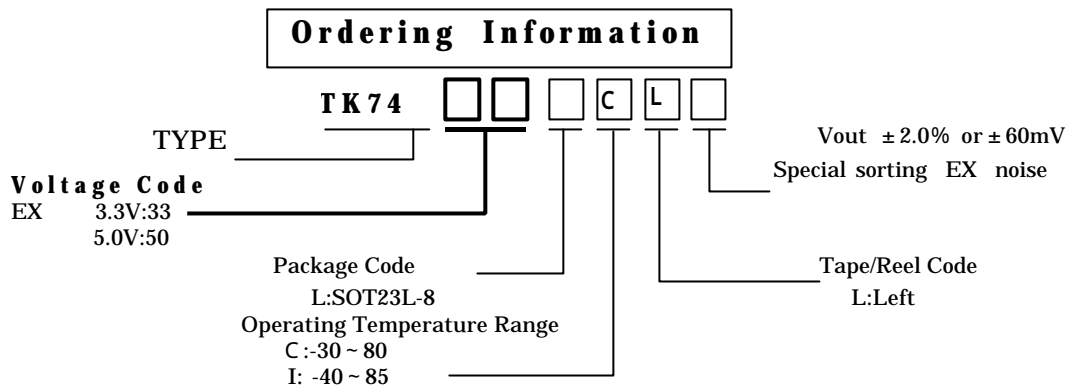

Boldface type applies Standard Voltage.

V OUT	V CODE	V OUT	V CODE	V OUT	V CODE	V OUT	V CODE
1.5 v	15	2.5 v	25	3.5 v	35	4.5 v	45
1.6	16	2.6	26	3.6	36	4.6	46
1.7	17	2.7	27	3.7	37	4.7	47
1.8	18	2.8	28	3.8	38	4.8	48
1.9	19	2.9	29	3.9	39	4.9	49
2.0	20	3.0	30	4.0	40	5.0	50
2.1	21	3.1	31	4.1	41		
2.2	22	3.2	32	4.2	42		
2.3	23	3.3	33	4.3	43		
2.4	24	3.4	34	4.4	44		

Please contact your authorized Toko representative for voltage availability

Absolute Maximum Ratings

Ta=25

Parameter	Symbol	Rating	Unit
Supply voltage	Vcc	-0.4 ~ 16	V
Storage Temperature Range	T stg	-55 ~ 150	
Reverse Bias	VR Max	-0.4 ~ 10	V
Control pin	Vcont	-0.4 ~ Vop	V
Power Dissipation	P d Max	Internal limited	(Mounted on board 600mW)
Thermal protection	Ohp	140	
Operating Condition			
Temperature Range	Top	- 30 ~ 80(- 40 ~ 85)	Ta
Voltage Range	Vop	1.8 ~ 14.5	V

Short circuit current: Side A	Ishort	430	mA
Short circuit current: Side B	Ishort	330	mA (fold-down protection.)

Electrical Characteristics(C rank) Vtest=VoutTyp+1v ; Vcont=1.8V (Ta=25)

Parameter	Symbol	Condition	Min	Typ	Max	Unit	
Common	Output voltage	Vout	Refer to Table 1 Iout=5mA				
	Line Regulation	LinReg	Vtest=VoutTyp+1v ~ to increase 5V ; Iout=5mA Vtest-Max 18V		0.0	5.0	mV
	Quiescent current	Iq	Iout=0mA Except Icont		45	75	μA
	Standby current	Istandby	Vcc=10V Off mode		0.0	0.1	μA
	Feedback term. Volt	Vfb		1.11	1.19	1.29	V
	on/off control		Pull down resistor for control terminal isn't built in.				
	Control current	Icont	Vcont=1.8V On mode		1.8	5	μA
	Control voltage	Vcont	Output On		1.8		V
Output Off					0.8	V	
Side A	Load regulation Note 1	LoaReg	Iout=5mA ~ 100mA		(14)	(30)	mV
			Iout=5mA ~ 200mA		(33)	(70)	
	Drop out voltage	Vdrop	I out=100mA		90	150	mV
			I out=150mA		125	180	
			I out=200mA		160	250	
	Drop out voltage	Vdrop	1.3V Vout 2.0V :No regulation Because of VopMin=1.8V				
Max. output current	IoutMax	Vout: 10% Down point、 Note 2		290	380	mA	
Side B	Load regulation: Note 1	LoaReg	Iout=5mA ~ 100m		(17)	(40)	mV
	Drop out voltage	Vdrop	I out=50mA		80	125	mV
			I out=100mA		135	220	
	Drop out voltage	Vdrop	1.3V Vout 2.0V No regulation Because of VopMin=1.8V				
Max output current	IoutMax	Vout: 10% Down point、 Note 2		190	280	mA	
Vout Temp. coefficient	Vo/Ta	I o=5mA Reference Value		70 PPM/			

The operation of -30 ~ -80 is guaranteed in the design by a usual inspection.

Note 1: This value depends on the output voltage. (It is a value of Vout=3V device. The value of details is described to Electrical specifications)

Note 2:The output current is limited by the power dissipation of the total of both sides.

Parameters with only typical values are just reference. (Not guaranty)

General Note: Limits are guaranteed by production testing or correction techniques using Statistical Quality Control (SQC) methods. Unless otherwise noted. Vtest=VoutTyp+1v ; IL=1mA (Tj=25) The operation of -30 ~ -80 is guaranteed in the design by a usual inspection.

General Note: Exceeding the "Absolute Maximum Rating " may damage the device

General Note: Ripple rejection is approximately 84dB

Electrical Characteristics (I rank)

Limits in standard typeface are for $T_a=25$, bold typeface applies over the -40 to $+85$ Ambient temperature range. **Operational Voltage Range is (2.1V Vop 14V)**. Unless otherwise noted. $V_{test}=V_{out_{Typ}}+1v$; $I_{out}=1mA$ ($T_a=25$)

Bold values indicate -40 to $+85$

Parameter	Symbol	Condition	Min	Typ	Max	Unit	
Output voltage	V_{out}	Refer Table 2 $I_o=5mA$					
Line Regulation	$LinReg$	$V_{test}=V_{out_{Typ}}+1v$ ~ to increase 5V ; $I_{out}=5mA$ $V_{test}-Max$ 18V		0.0	5.0 7	mV	
Quiescent current	I_q	$I_{out}=0mA$ Except I_{cont}		45	75 95	μA	
Standby current	$I_{standby}$	$V_{cc}=10V$ Off mode		0.0	0.1 3	μA	
Feedback term. Volt	V_{fb}		1.10	1.19	1.30	V	
Control current	I_{cont}	on/off control Pull down resistor for control terminal isn't built in. $V_{cont}=1.8V$ ON mode		1.8	5 7	μA	
Control voltage	V_{cont}	Output ON	1.8 2.0			V	
		Output OFF			0.8 0.6	V	
Side A	Load regulation Note 1	$I_{out}=5mA \sim 100mA$		(14)	(30) 39	mV	
		$I_{out}=5mA \sim 200mA$		(33)	(70) (90)		
	Drop out voltage	$I_{out}=100mA$		90	150 180	mV	
		$I_{out}=150mA$		125	180 230		
		$I_{out}=200mA$		160	250 300		
	Drop out voltage	V_{drop}	1.3V V_{out} 2.0V :No regulation Because of $V_{opMin}=2.1V$				
	Max output current	$I_{out_{Max}}$	V_{out} : 10% Down point、 Note 2	290 250	380		mA
Side B	Load regulation Note 1	$I_{out}=5mA \sim 100mA$		(17)	(40) 50	mV	
		Drop out voltage	$I_o=50mA$		80	125 175	mV
	$I_o=100mA$			135	220 280		
	Drop out voltage	V_{drop}	1.3V V_{out} 2.0V No regulation Because of $V_{opMin}=2.1V$				
	Max output current	$I_{out_{Max}}$	V_{out} : 10% Down point、 Note 2	190 150	280		mA
Vout Temp. coefficient	V_o/T_a	Vout Temp. coefficient $I_o=5mA$ Reference Value			70PPM/		

Note 1: This value depends on the output voltage.

(It is a value of $V_{out}=3V$ device. The value of details is described to individual specifications.)

Note 2: The output current is limited by the power dissipation of the total of both sides.

Parameters with only typical values are just reference. (Not guaranty)

General Note: Limits are guaranteed by production testing or correction techniques using Statistical Quality Control (SQC) methods. Unless otherwise noted. $V_{test}=V_{out_{Typ}}+1v$; $I_L=1mA$ ($T_j=25$) The operation of -30 -80 is guaranteed in the design by a usual inspection.

General Note: Exceeding the "Absolute Maximum Rating" may damage the device

General Note: Ripple rejection is approximately 84dB

\uparrow $V_{nois}=0.2V_{p-p}$, 1KHz, $V_{in}=V_{out_{Typ}}+1.5v$, $I_o=10mA$] [$C_L=1.0\mu F$ tantalum Cap. $C_{fb}=4700pF$]

TABLE 1
C rank device output voltage list (Ta=25 Iout=5mA)

Output Voltage	Voltage Code	Vout Min	Vout Max	Test Voltage	Output Voltage	Voltage Code	Vout Min	Vout Max	Test Voltage
1.3V	13	1.240V	1.360V	2.4V	3.4V	34	3.232V	3.468V	4.4V
1.4	14	1.340	1.460	2.4	3.5	35	3.430	3.570	4.5
1.5	15	1.440	1.560	2.5	3.6	36	3.528	3.672	4.6
1.6	16	1.540	1.660	2.6	3.7	37	3.626	3.774	4.7
1.7	17	1.650	1.760	2.7	3.8	38	3.724	3.876	4.8
1.8	18	1.740	1.860	2.8	3.9	39	3.822	3.978	4.9
1.9	19	1.870	1.960	2.9	4.0	40	3.920	4.080	5.0
2.0	20	1.940	2.060	3.0	4.1	41	4.018	4.182	5.1
2.1	21	2.040	2.160	3.1	4.2	42	4.116	4.284	5.2
2.2	22	2.140	2.260	3.2	4.3	43	4.214	4.386	5.3
2.3	23	2.240	2.360	3.3	4.4	44	4.312	4.488	5.4
2.4	24	2.340	2.460	3.4	4.5	45	4.410	4.590	5.5
2.5	25	2.440	2.560	3.5	4.6	46	4.508	4.692	5.6
2.6	26	2.540	2.660	3.6	4.7	47	4.606	4.794	5.7
2.7	27	2.640	2.760	3.7	4.8	48	4.704	4.896	5.8
2.8	28	2.740	2.860	3.8	4.9	49	4.802	4.998	5.9
2.9	29	2.840	2.960	3.9	5.0	50	4.900	5.100	6.0
3.0	30	2.940	3.060	4.0					
3.1	31	3.038	3.162	4.1					
3.2	32	3.136	3.264	4.2					
3.3	33	3.234	3.366	4.3					

The output voltage table indicates the standard value when manufactured.

Table 2**I rank device output voltage list** (I_{out}=5mA)**Boldface type** applies over the full operating temperature range. (-40 ~ 85)I_{out}=5mA

Output Voltage	Voltage Code	Vout Min	Vout Max	Test Voltage	Output Voltage	Voltage Code	Vout Min	Vout Max	Test Voltage
1.8V	18	1.750 1.720	1.850 1.880	2.8	3.8	38	3.750 V 3.720	3.850 V 3.880	4.8 V
2.0V	20	1.950V 1.920	2.050V 2.080	3.0	3.9	39	3.850 3.820	3.950 3.980	4.9
2.1	2.1	2.250 2.220	2.150 2.180	3.1	4.0	40	3.950 3.910	4.050 4.090	5.0
2.2	2.2	2.150 2.120	2.250 2.280	3.2	4.1	41	4.050 4.009	4.150 4.191	5.1
2.3	2.3	2.260 2.220	2.350 2.380	3.3	4.2	42	4.150 4.108	4.250 4.292	5.2
2.4	24	2.350 2.320	2.450 2.480	3.4V	4.3	43	4.250 4.197	4.350 4.393	5.3
2.5	25	2.450 2.420	2.550 2.580	3.5	4.4	44	4.350 4.306	4.450 4.494	5.4
2.6	26	2.550 2.520	2.650 2.680	3.6	4.5	45	4.450 4.405	4.550 4.595	5.5
2.7	27	2.650 2.620	2.750 2.780	3.7	4.6	46	4.550 4.504	4.650 4.696	5.6
2.8	28	2.750 2.720	2.850 2.880	3.8	4.7	47	4.050 4.606	4.750 4.797	5.7
2.9	29	2.850 2.820	2.950 2.980	3.9	4.8	48	4.750 4.702	4.850 4.898	5.8
3.0	30	2.950 3.920	3.050 3.080	4.0	4.9	49	4.850 4.801	4.950 4.999	5.9
3.1	31	3.050 3.020	3.150 3.180	4.1	5.0	50	4.950 4.900	5.050 5.100	6.0
3.2	32	3.150 3.120	3.250 3.280	4.2					
3.3	33	3.250 3.220	3.350 3.380	4.3					
3.4	34	3.350 3.320	3.450 3.480	4.4					
3.5	35	3.450 3.420	3.550 3.580	4.5					
3.6 V	36	3.550 3.520	3.650 3.680	4.6					
3.7	37	3.650 3.620	3.750 3.780	4.7					

The output voltage table indicates the standard value when manufactured.

Pin assignment

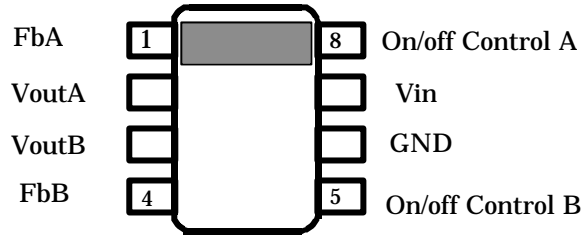

Top view

Test circuit

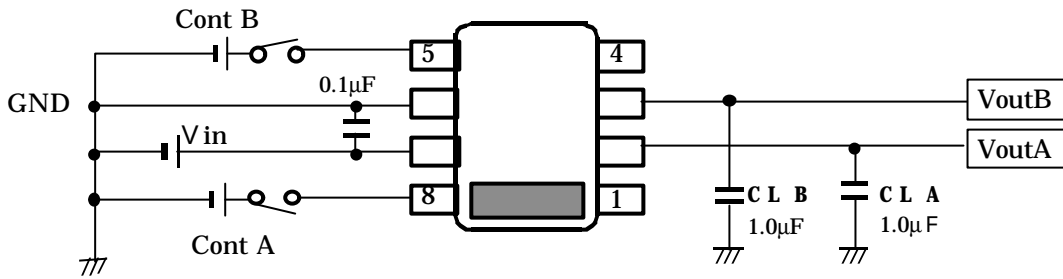

Block diagram

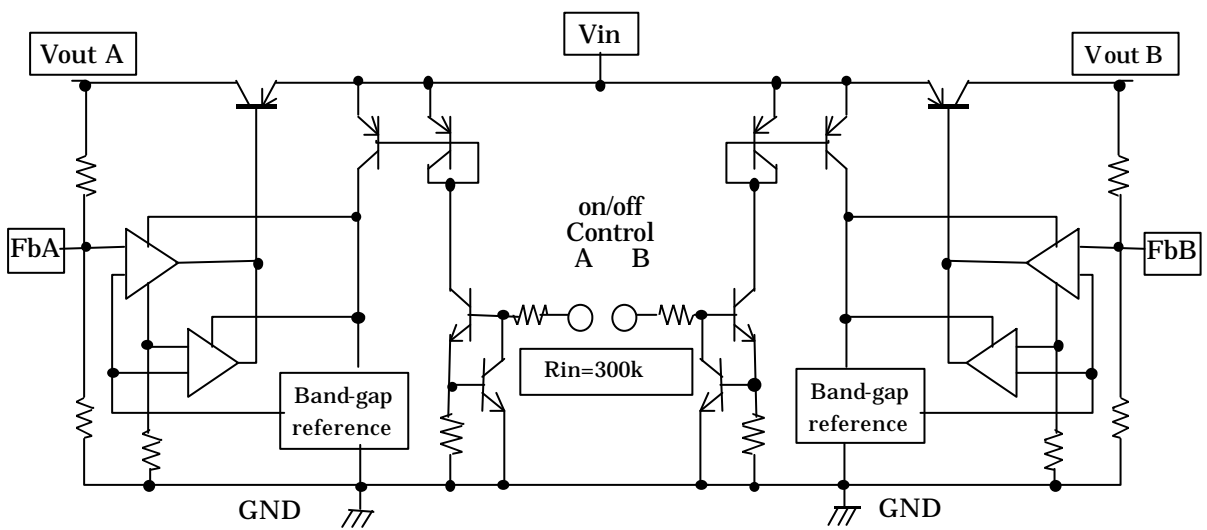

Built in Thermal & Over Current Protection

Input /Output Capacitors

Linear regulators require input and output capacitors in order to maintain the regulator's loop stability. The equivalent series resistance (ESR) of the output capacitor must be in the stable operation area. However, it is recommended to use as large a value of capacitance as is practical. The output noise and the ripple noise decrease as the capacitance value increases.

ESR values vary widely between ceramic and tantalum capacitors. However, tantalum capacitors are assumed to provide more ESR damping resistance, which provides greater circuit stability. This implies that a higher level of circuit stability can be obtained by using tantalum capacitors when compared to ceramic capacitors with similar values.

The recommended value : $C_{in}=C_L=0.1\mu F(MLCC)$ $I_{out} \leq 0.5mA$.

The input capacitor is necessary when the battery is discharged, the power supply impedance increases, or the line distance to the power supply is long. This capacitor might be necessary on each individual IC even if two or more regulator ICs are used. It is not possible to determine this indiscriminately. Please confirm the stability while mounted.

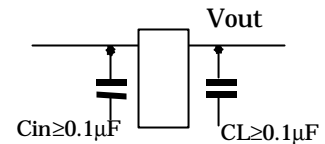

The IC provides stable operation with an output side capacitor of 0.1 μF ($V_{out} = 1.8V$). If it is 0.1 μF or more over the full range of temperature, either a ceramic capacitor or tantalum capacitor can be used without considering ESR. It is not possible to say indiscriminately. Please confirm stability while mounted.

Stable operation area vs. voltage, current, and ESR

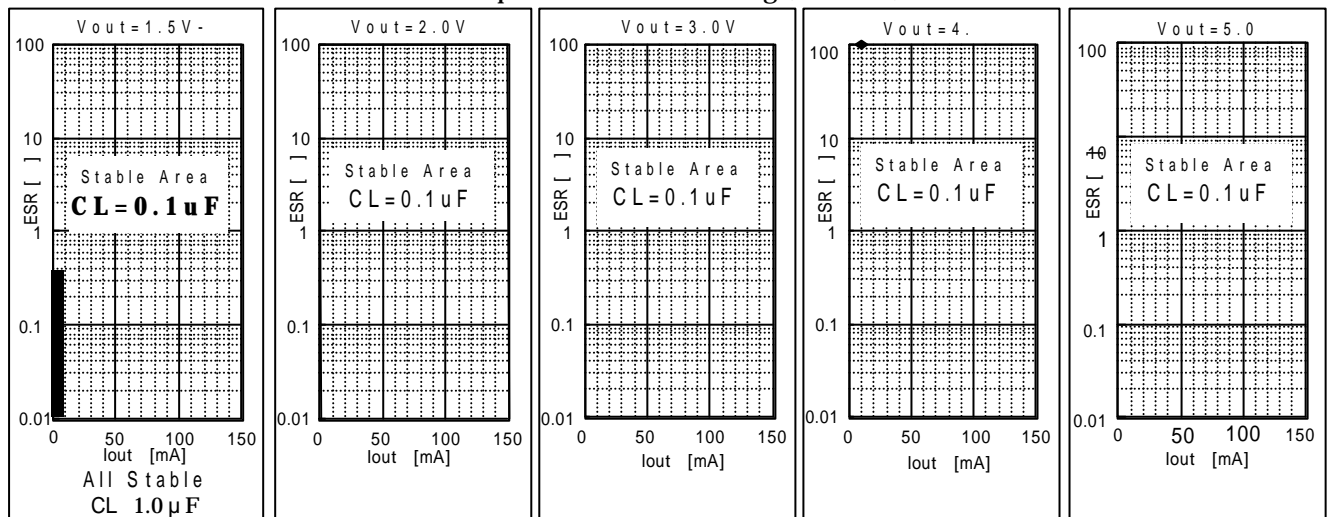

Please increase the output capacitor value when the load current is 5mA or less. The stability of the regulator improves if a big output side capacitor is used (the stable operation area extends.)

For evaluation
 KYOCERA CM05B104K10AB, CM05B224K10AB, CM105B104K16A, CM105B224K16A, CM21B225K10A
 MURATA GRM36B104K10, GRM42B104K10 GRM39B104K25, GRM39B224K10, GRM39B105K6.3

Bias Voltage and Temperature Characteristics of Ceramic Capacitor

Generally, a ceramic capacitor has both a temperature characteristic and a voltage characteristic. Please consider both characteristics when selecting the part. The B curves are the recommend characteristics.

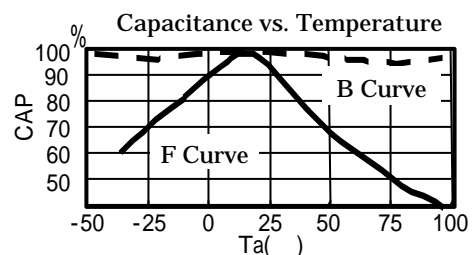
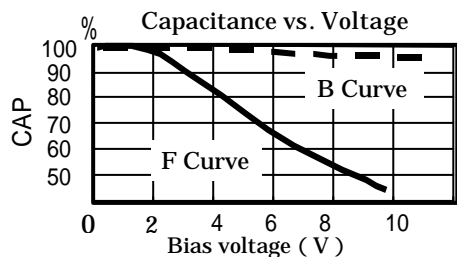

Standard Application

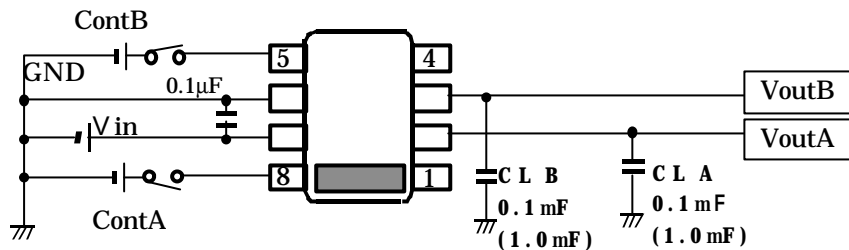

Typically, give the capacitor as large a value as practical in consideration of the temperature characteristic. The output noise and ripple noise decrease with a larger capacitance value. In addition, the response to the output side load change also improves.

Output voltage change

The output voltage on both sides can be set by using R1 and R2. The output voltage is decided by the ratio of R1 and R2. The error of the output voltage usually grows.

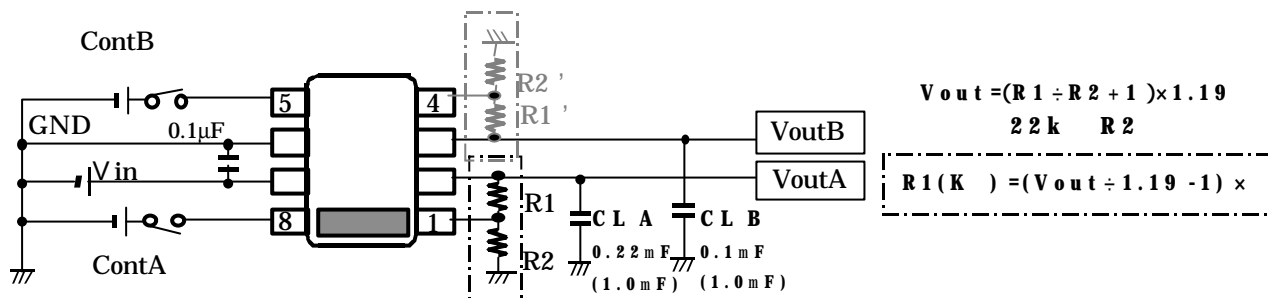

Noise reduction (Improvement of ripple rejection ratio)

Please connect Cfb with the FbA terminals (1 and 2) and the FbB terminals (3 and 4). It is possible to use Cfb only on the needed side. **The tantalum capacitor is the best in this application.** A small capacitance is sufficient (0.1 μF, 0.22μF, etc.). When the ceramic capacitor is used, the noise grows in the low current region. If 1.0 (Rs - 1) is connected in series with the ceramic capacitor, the same characteristics as a tantalum capacitor can be obtained. Please adjust the output side capacitor to the value in which stable operation is done over all required temperature ranges. Damage will not be caused by enlarging this value. Increasing this value will decrease the ripple noise and improve the output load transient response. However, the risetime using the on/off control becomes slower. It is possible to use the noise reduction application with the output voltage change application above.

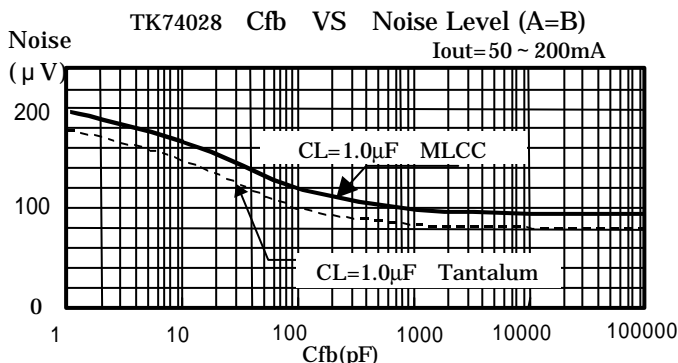
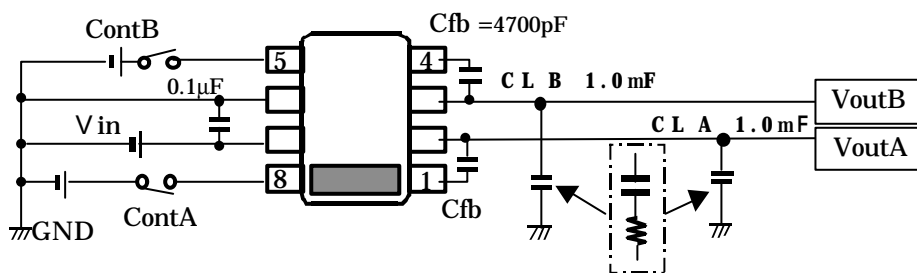

We recommend 4700pF for Cfb

Ripple Rejection (TK74030L)

Condition Vin=4.0V , Vripple=500mVp-p , Cin=0uF , Iout=10mA , Cout=1.0uF(MLCC) , Cfb=4700pF

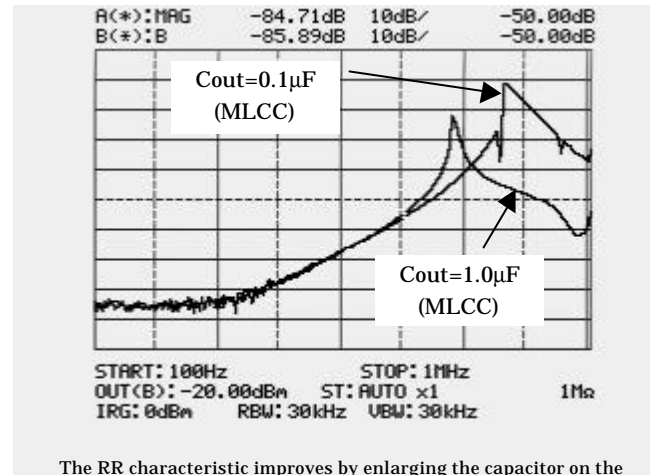
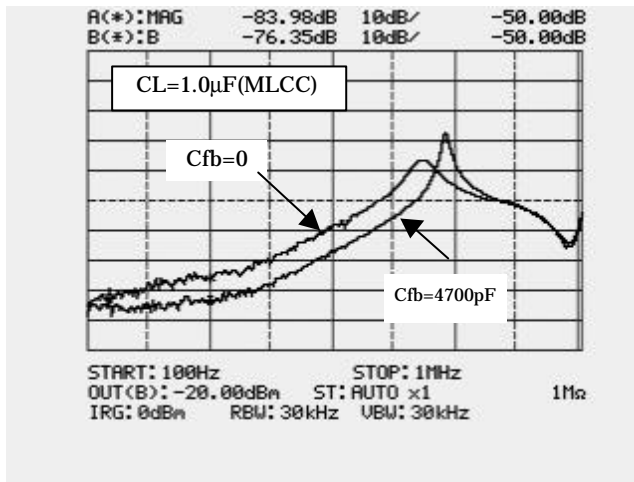

The RR characteristic improves by enlarging the capacitor on the output side. The characteristic of the high frequency area is decided by the characteristic of the output side capacitor.

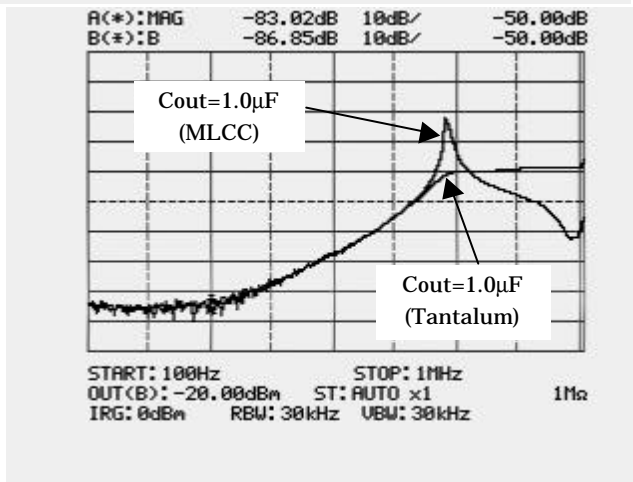

Output noise

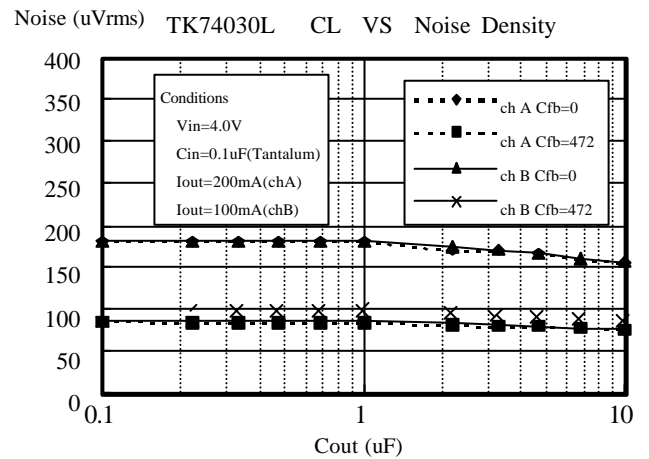
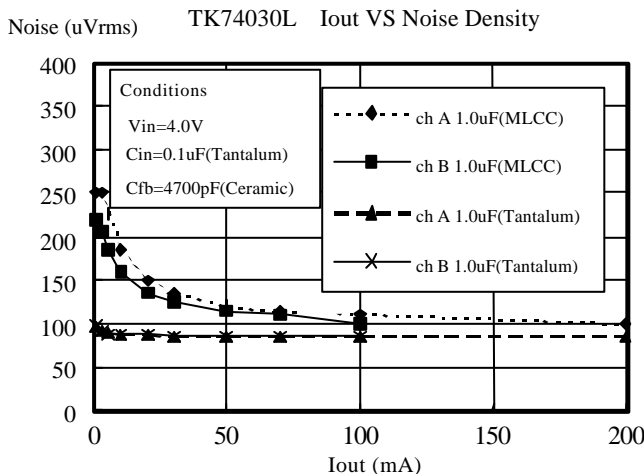

The noise in the low current region decreases when the tantalum capacitor is used. As for the output side capacitor, a tantalum capacitor of 0.1 uF is recommended. The characteristic of the capacitor greatly influences the amount of the noise.

low I/O voltage difference and High current LDO

Connect the following terminals: pin5 and pin8, pin1 and pin4, pin2 and pin3.

Vdrop=70mV at 100mA: 125mV at 200mA: 180mV at 300mA is typically obtained.

Attention when this application is adopted

The control current and the no load current double because the A and B circuits are connected in parallel. A very large current flows at the output during a short-circuit. Therefore, there is a possibility of damage by the current. Please note the short-circuit of the output side and GND. The current value that can regularly be delivered is 300-400mA. The output current is limited by the permissible electric power loss of the package. The current cannot be delivered exceeding this. However, a large peak current can be delivered for the pulse load with little generation of heat. The permissible loss increases by improving heat radiation. Please make the copper pattern in the IC part installation as wide as possible.

For instance, the permissible electric power loss increases greatly if the board thermal plane is bonded to the IC. The characteristic of this application is not guaranteed immediately because Toko does not test to this application. The characteristic of this application is almost obtained by guaranteeing the characteristic on the A side and the B side. The difference appears large; use care when designing.

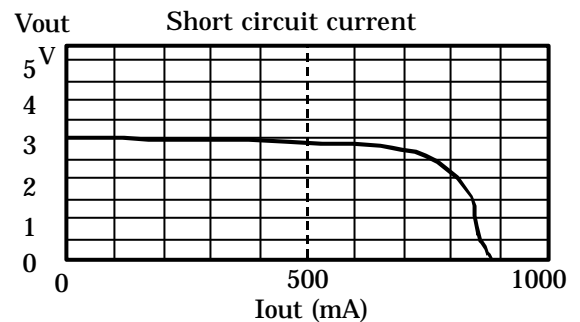
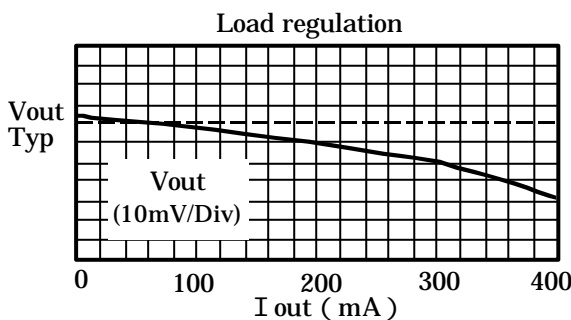
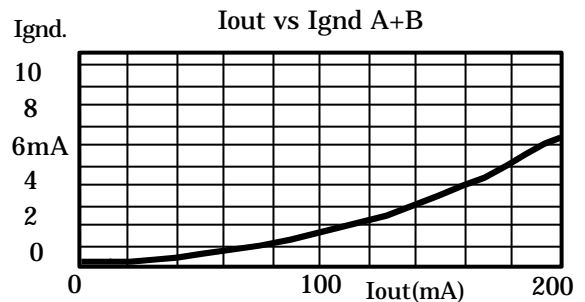
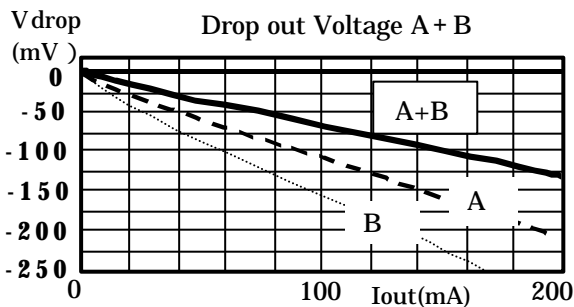
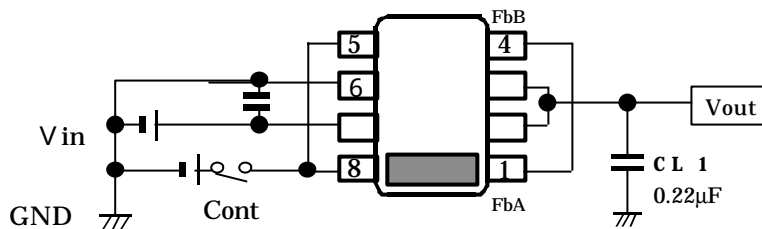

Improvement of load regulation with high current application

Please connect a resistor (Max=1.2 1.6) between pin6 of the TK740xx and GND.

The load regulation is greatly improved. Please enlarge the I/O capacitors.

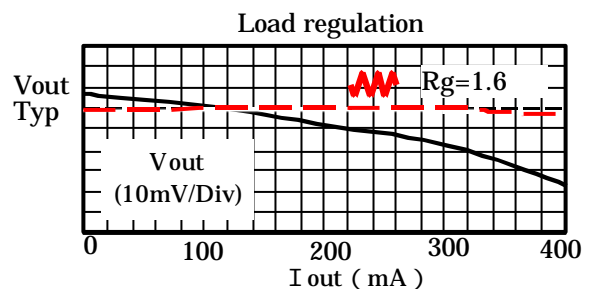
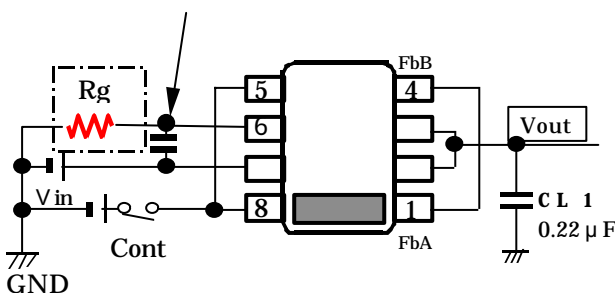

Line Transient

Vin=4 5 4 (V) , Cin=1.0uF(MLCC) , Cfb=472
A side (Iout=100mA)

B side (Iout=50mA)

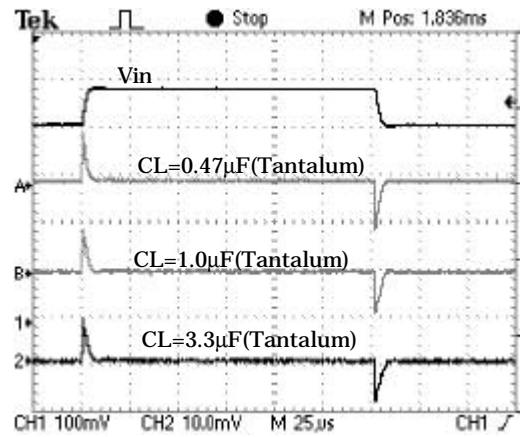
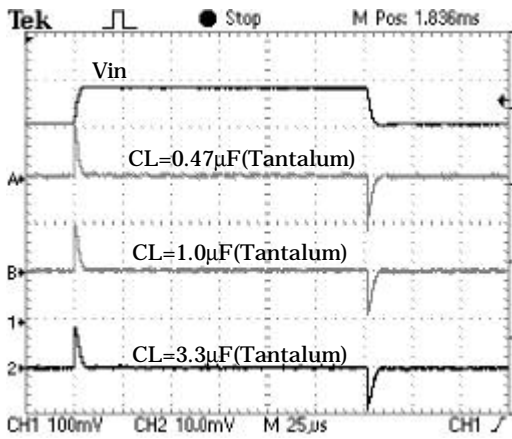
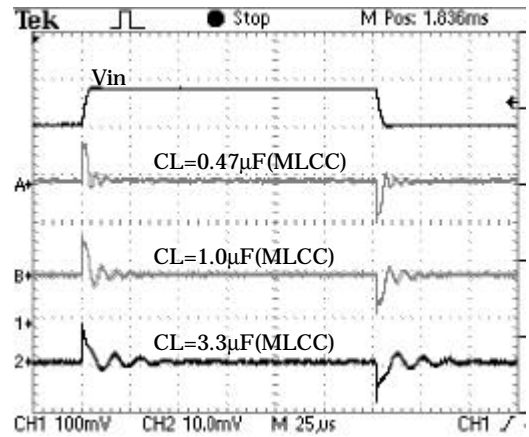
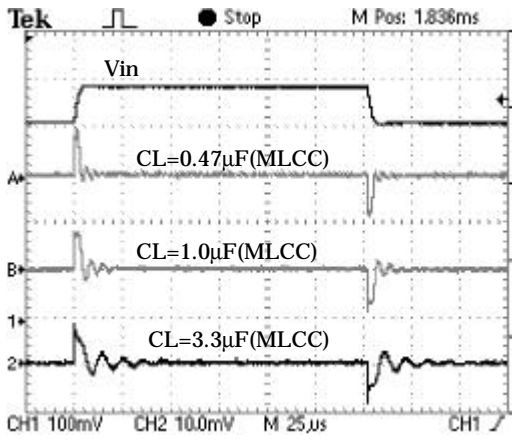

Load Transient

Vin=4V , , Cin=1.0μF(MLCC)

A side (Iout=5-100-5mA)

B side (Iout=5-50-5mA)

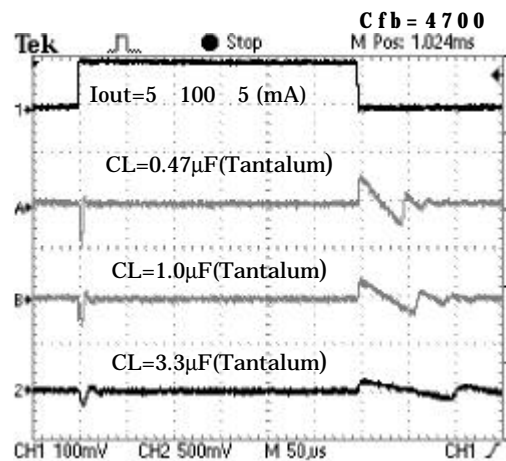
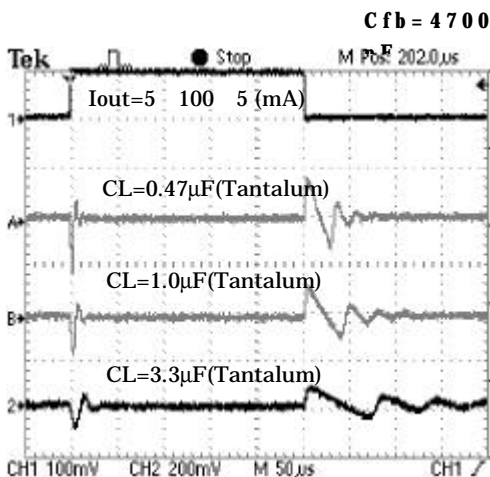
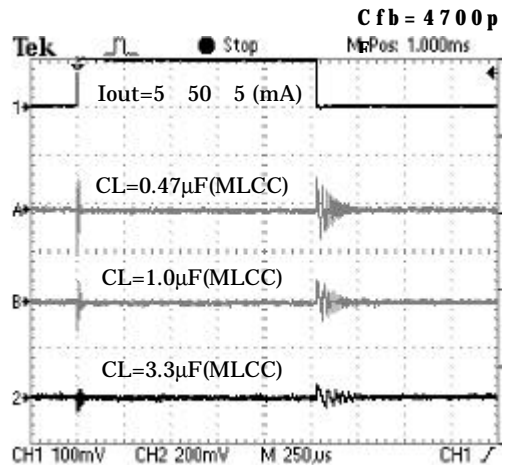
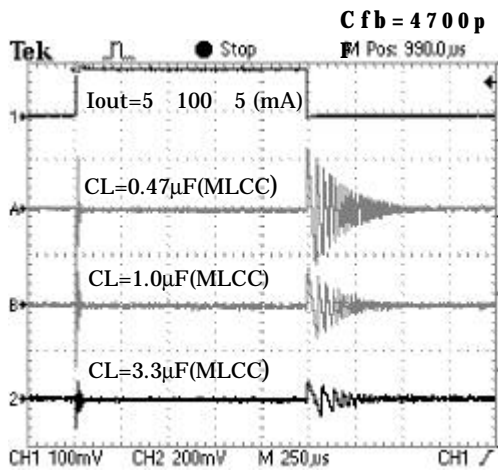
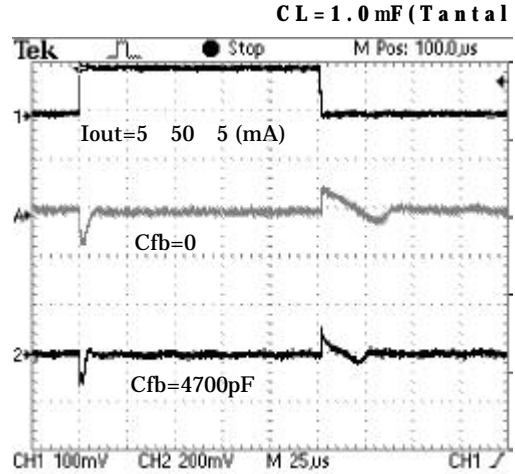
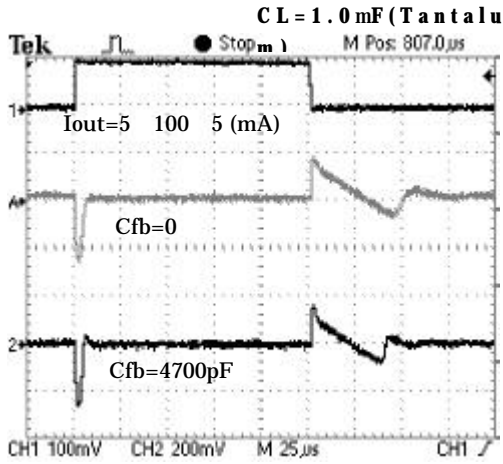

ON/OFF Transient

$I_{out}=10mA$, $C_{in}=0.1\mu F(MLCC)$, $C_L=1.0\mu F(MLCC)$

A side

B side

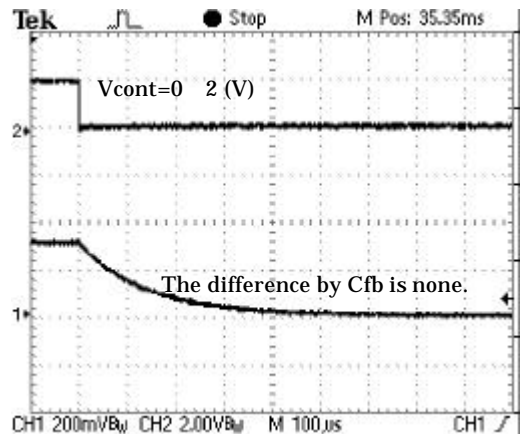
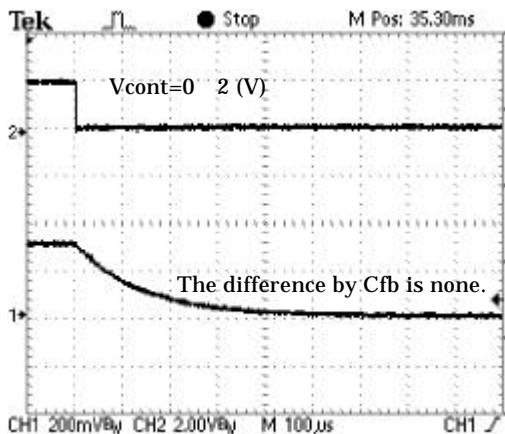
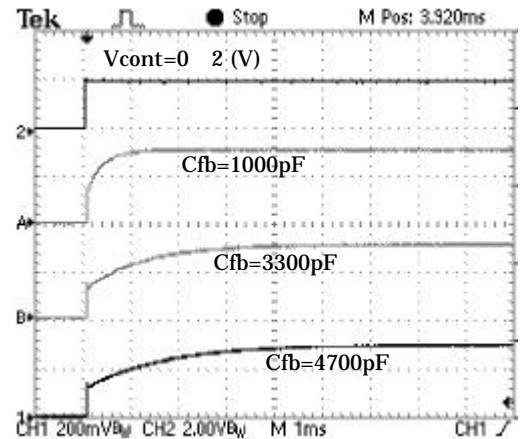
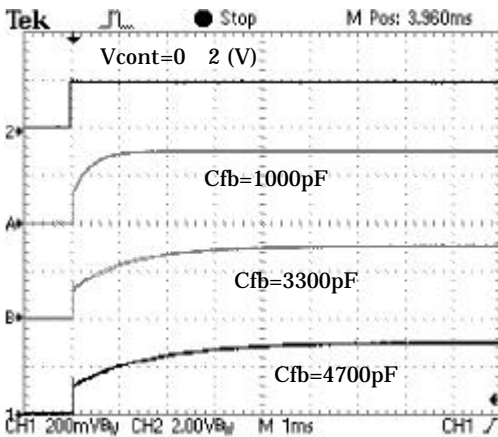
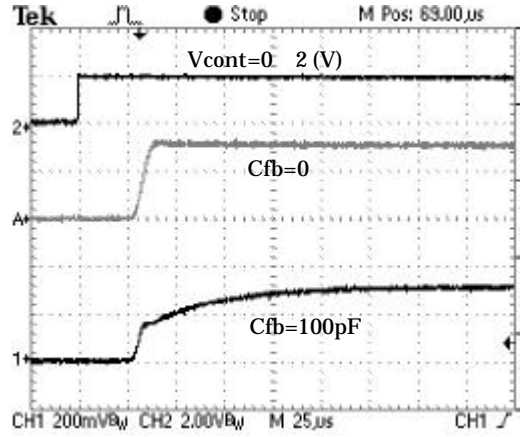
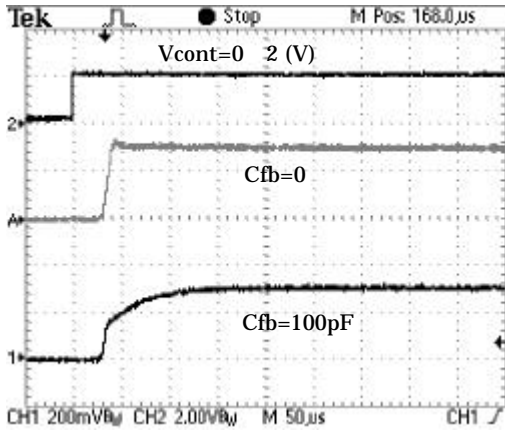



Cross Regulation.

Cin=0.1μF CL=1.0μF(MLCC) Cfb=None

The output voltage change of making the load current rapidly change in the A side or B side (in 5-50,5-100,5-200mA steps), compared with the no-change side is observed. The current on the side where the load current is not allowed to change is 5mA constant. The measurement sensitivity on the side without the current change is 5mV/div.: the side with the current change is 200mV/div.

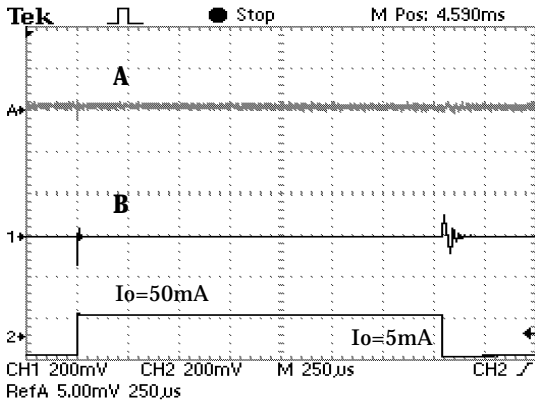
A : 5mA(const) B : 5  50mA



A : 5mA(const) B : 5  100mA

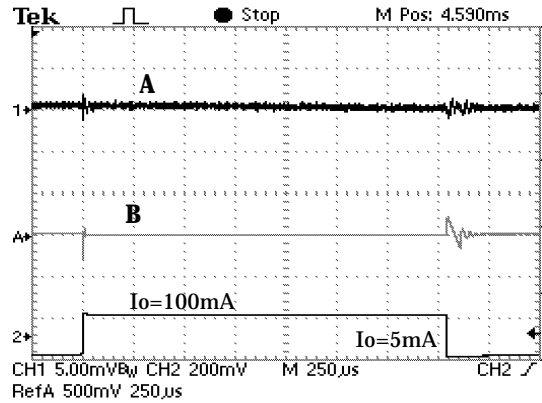

A : 5  50mA B : 5mA(const)

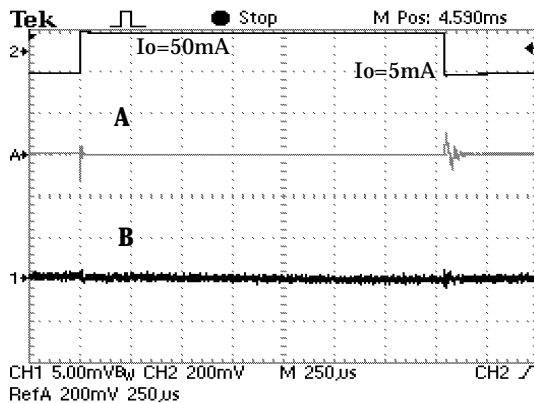

A : 5  100mA B : 5mA(const)

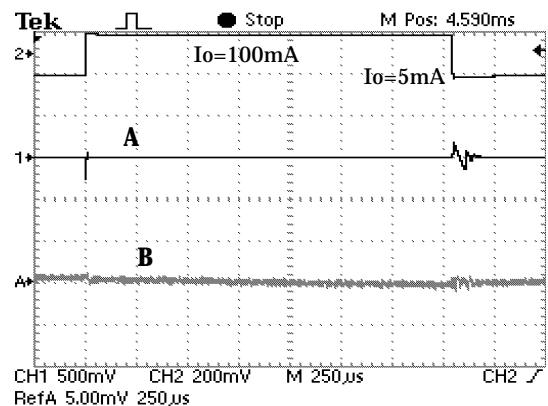

A : 5  200mA B : 5mA(const)

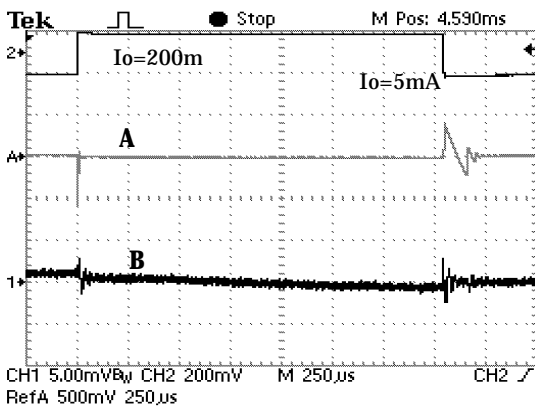

Ripple rejection when I/O voltage difference is few.

When the difference between the input voltage and the output voltage decreases, the RR characteristic is different in Side A and Side B. The characteristic on the A side (where the power transistor is large) improves.

With Cfb

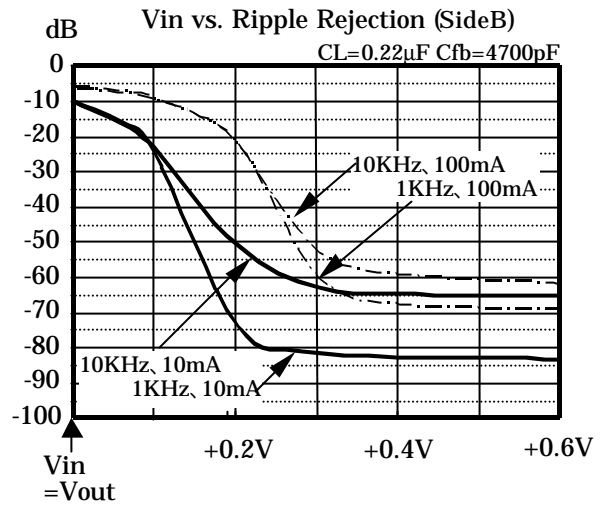
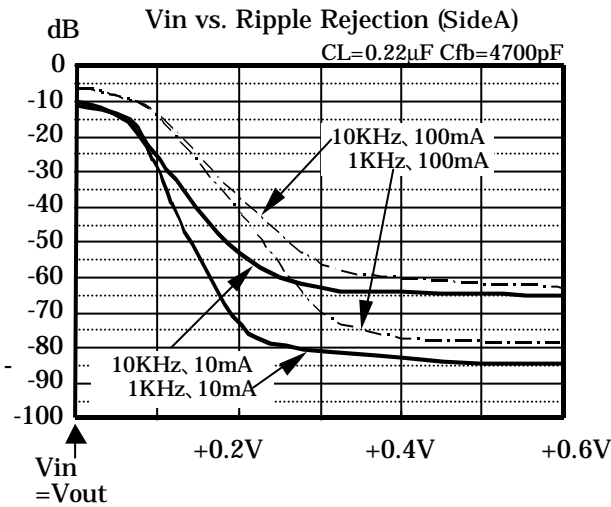
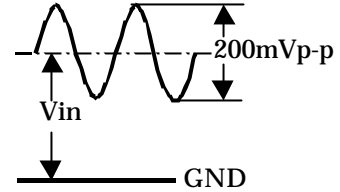
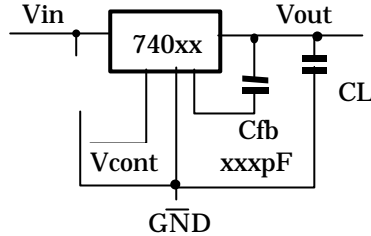

Without Cfb

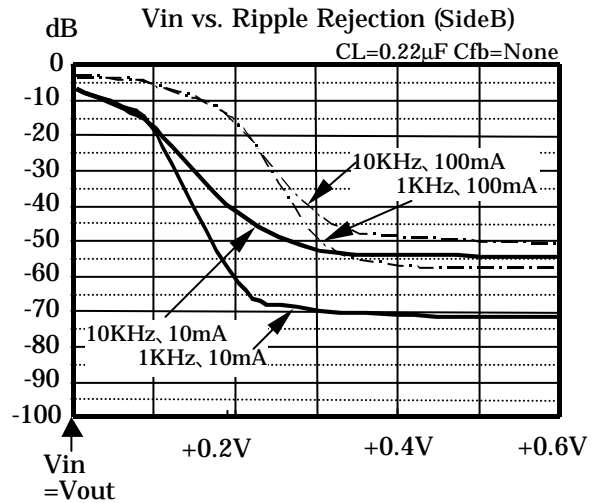
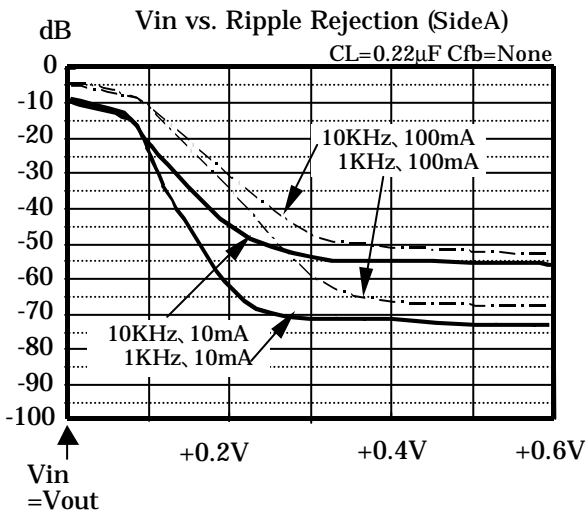
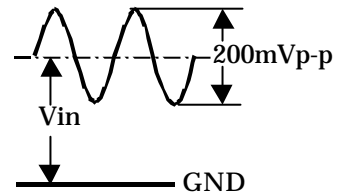
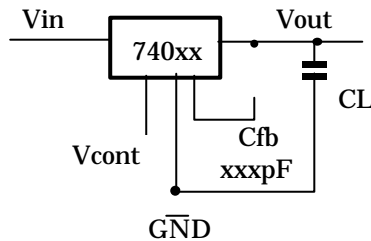

Typical Performance

A and B: Common Characteristics

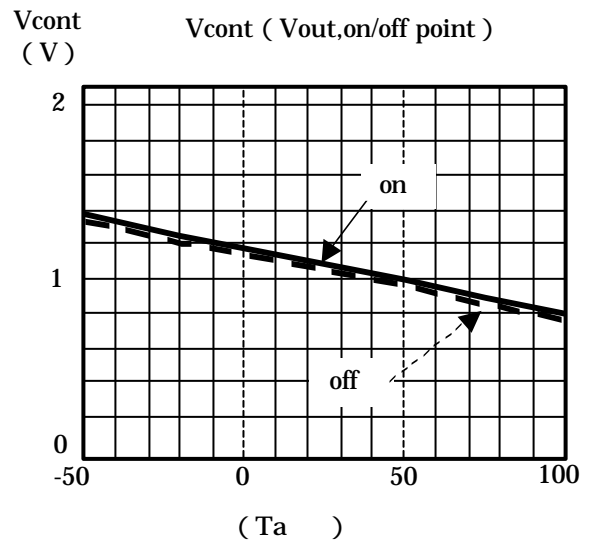
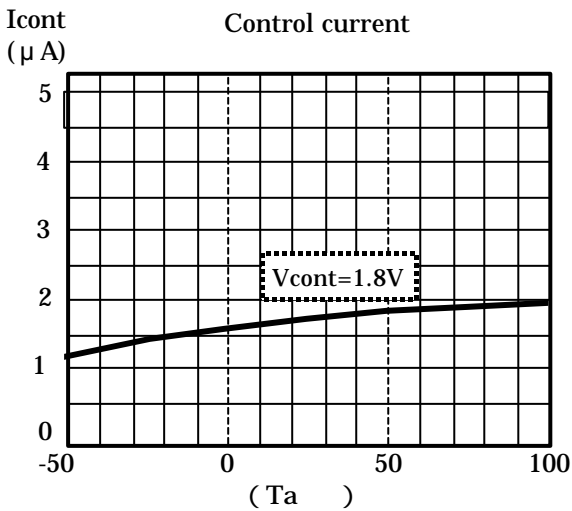
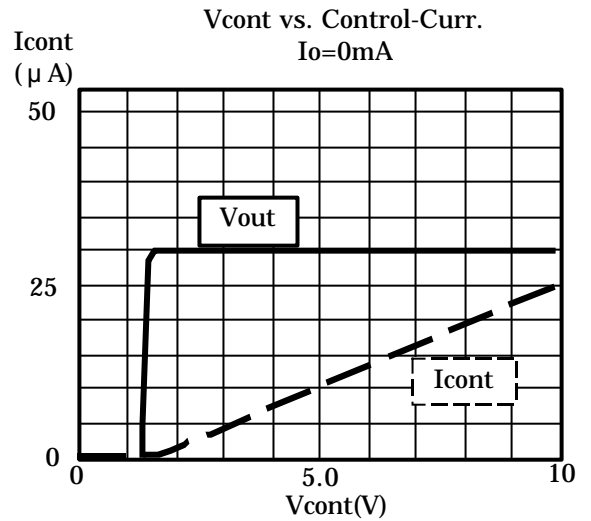
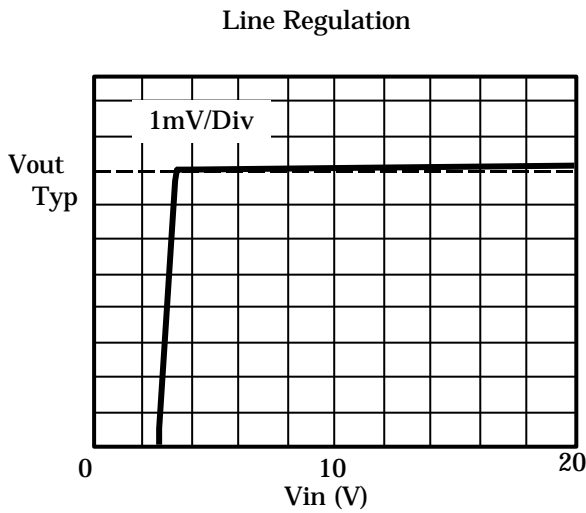
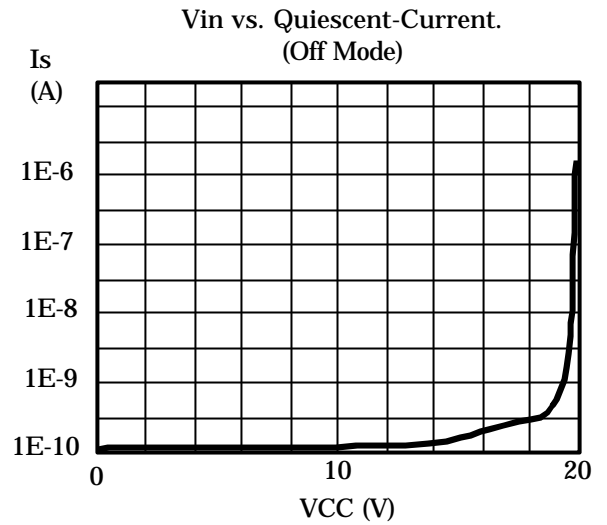
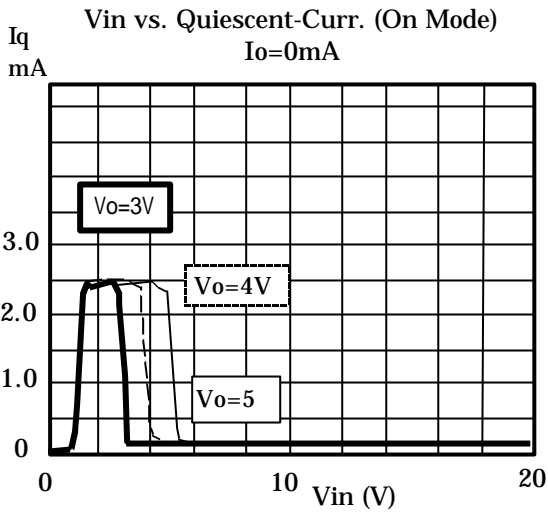

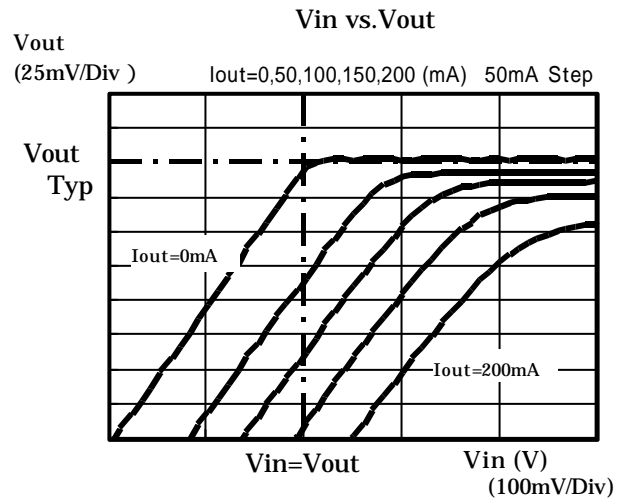
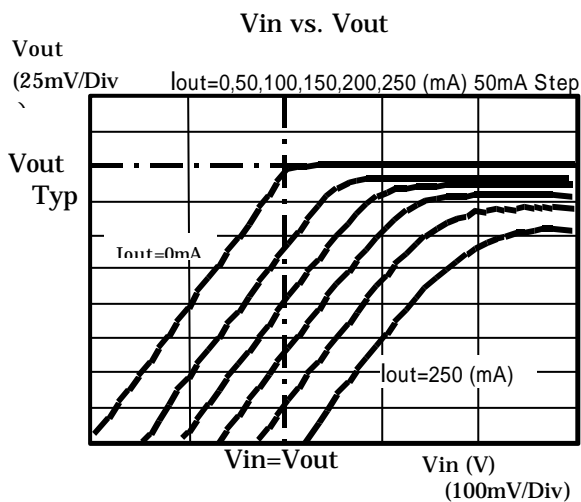
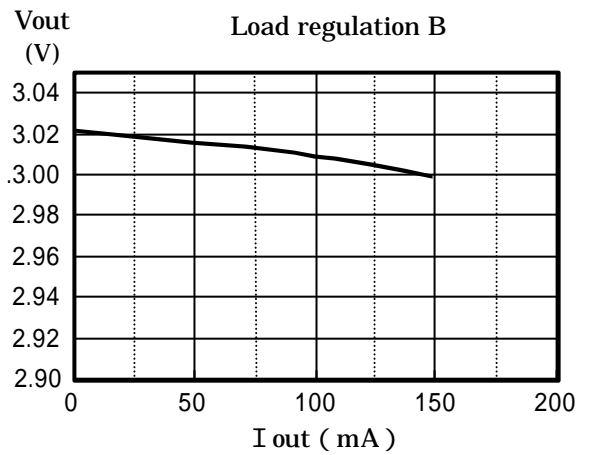
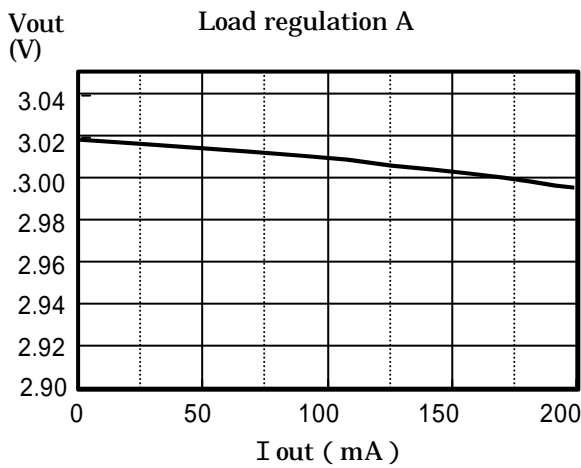
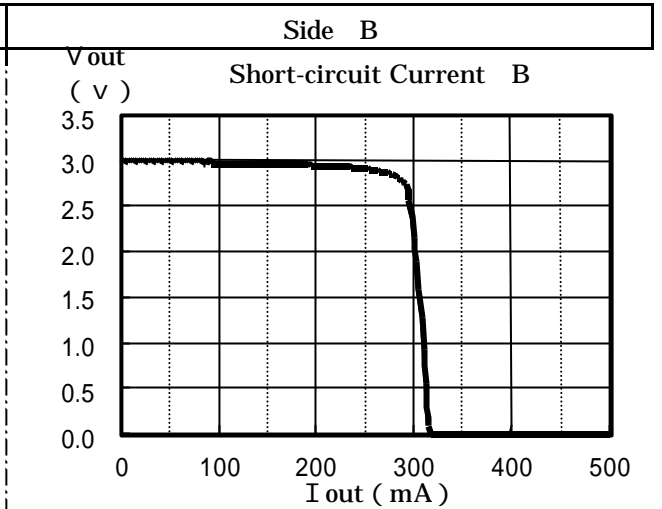
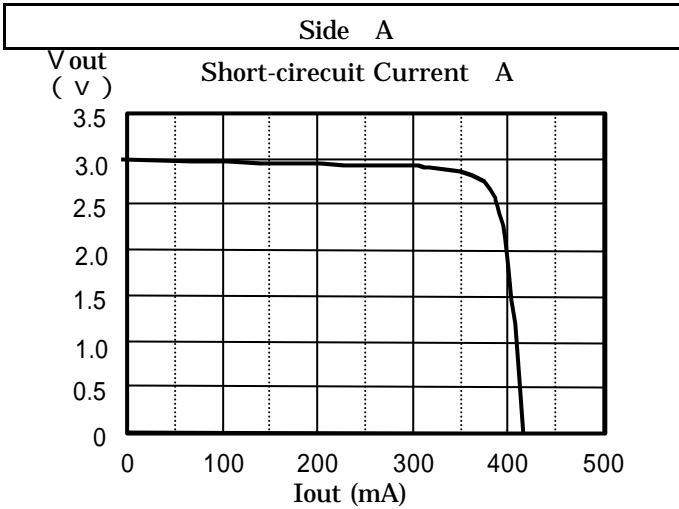

Side A	Side B
--------	--------

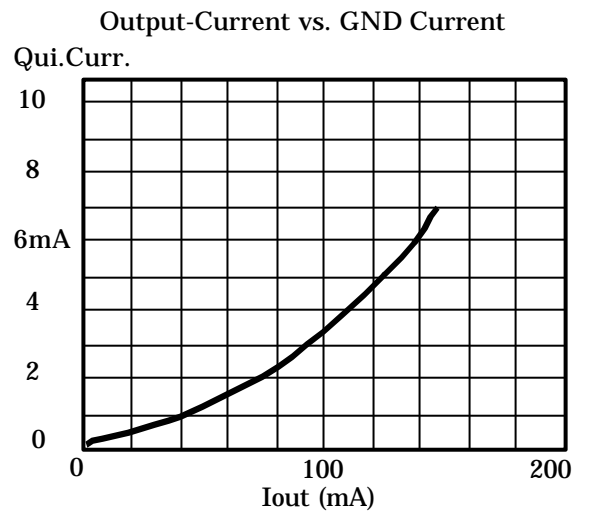
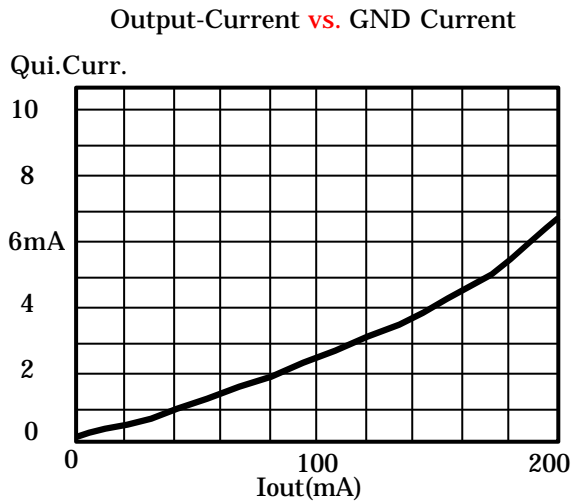
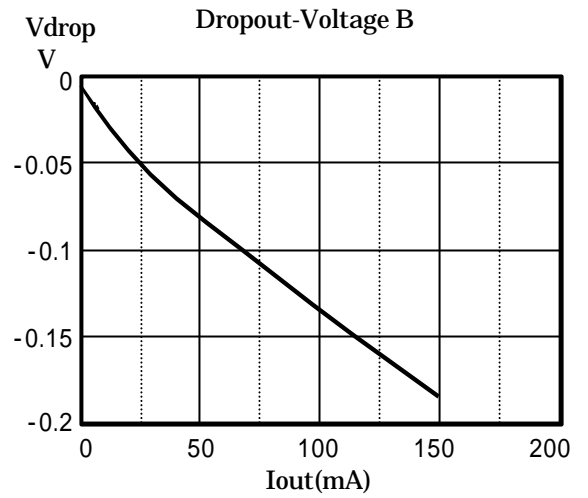
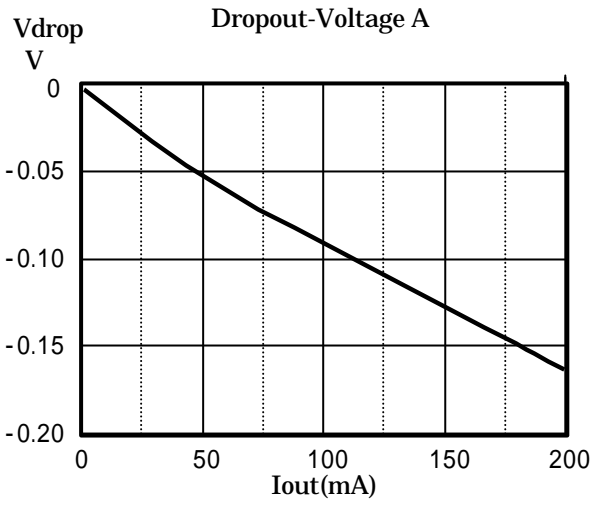

Ambient temperature behavior

Ta: Ambient temperature

Side A	Side B
--------	--------

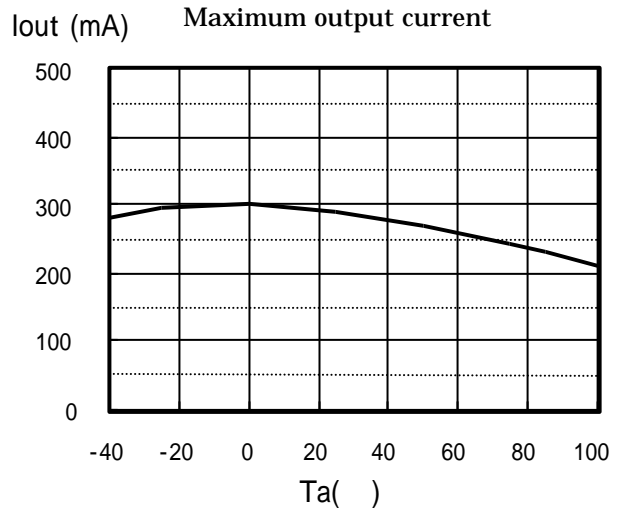
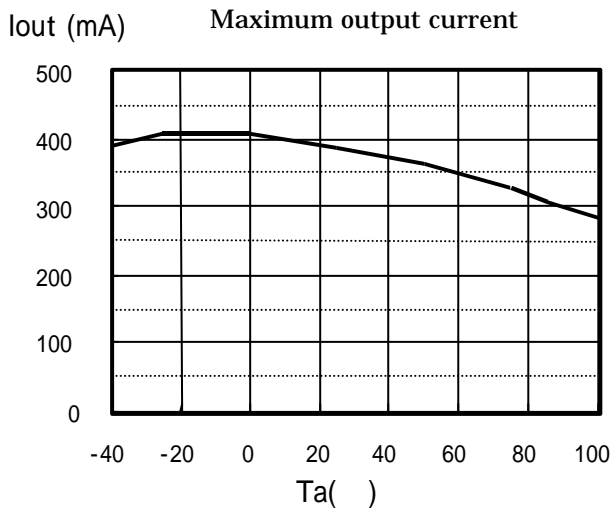
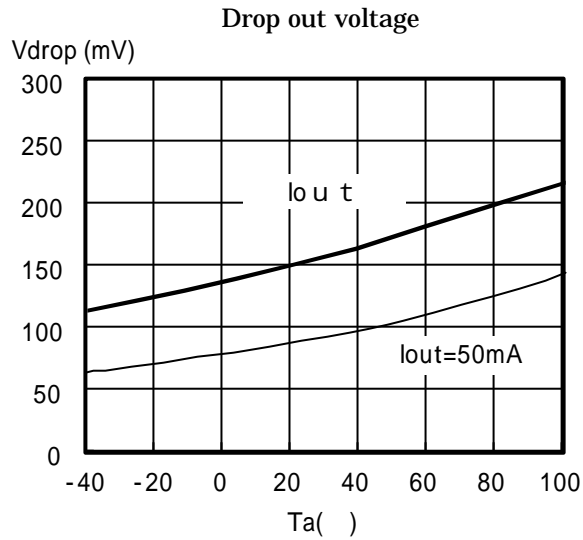
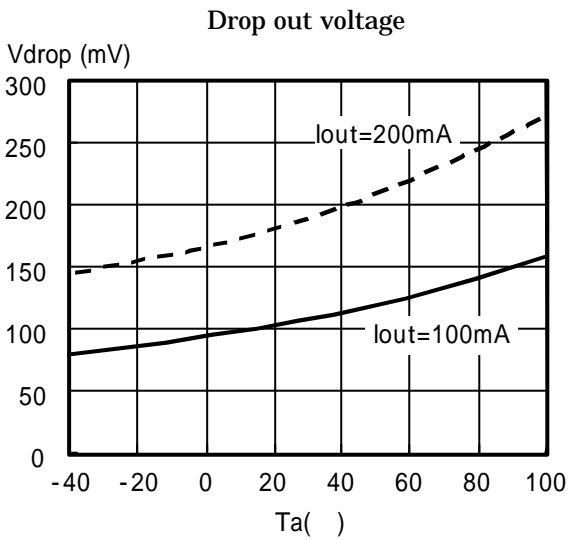
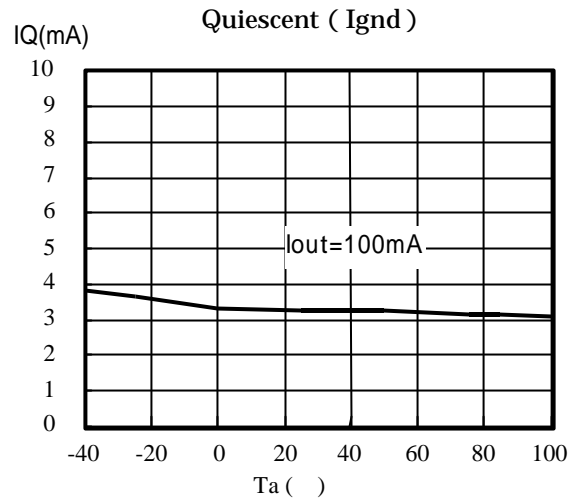
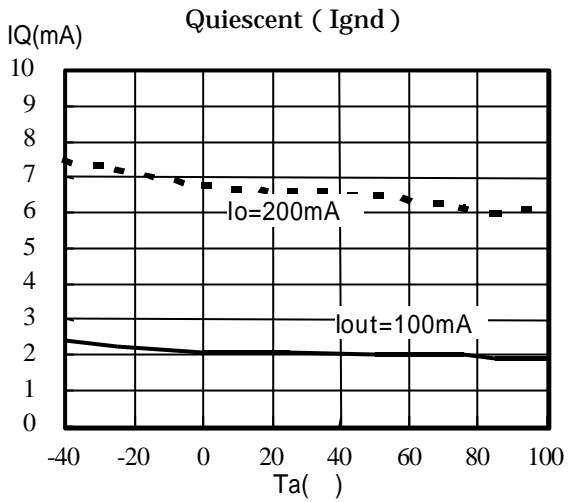

Output Voltage Temperature behavior

(I_{out}=5mA)

T_a: Ambient temperature

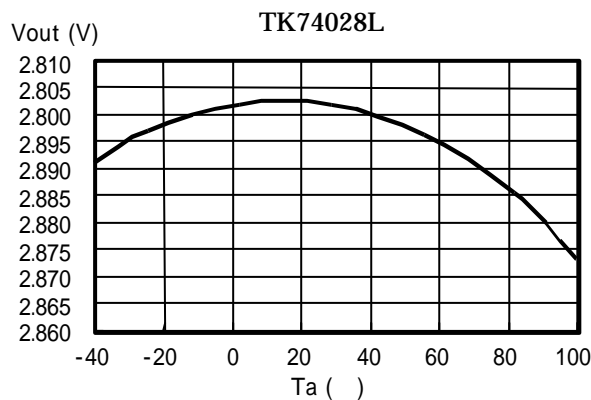
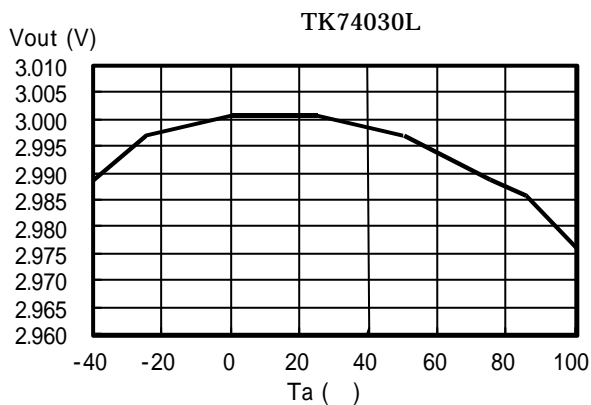
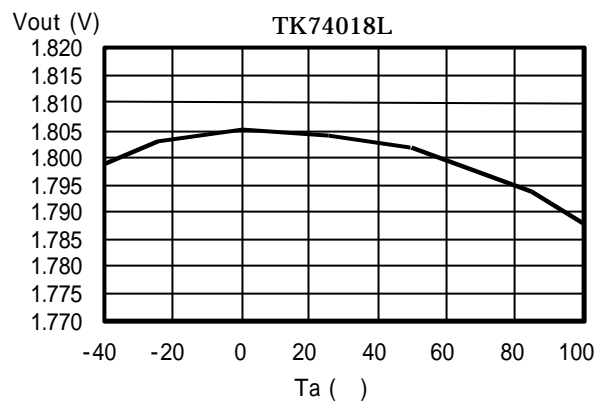
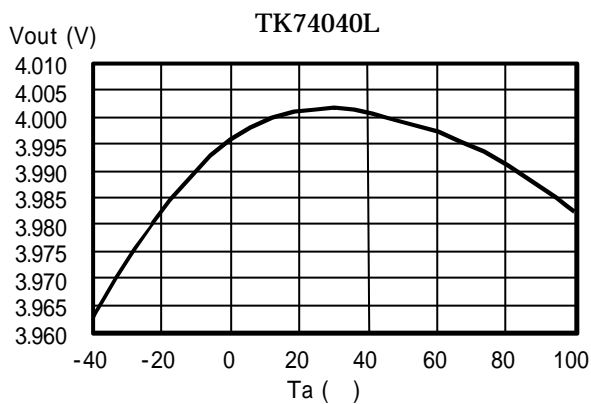
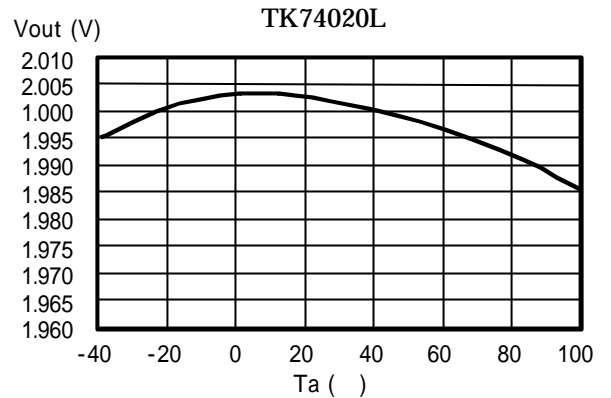
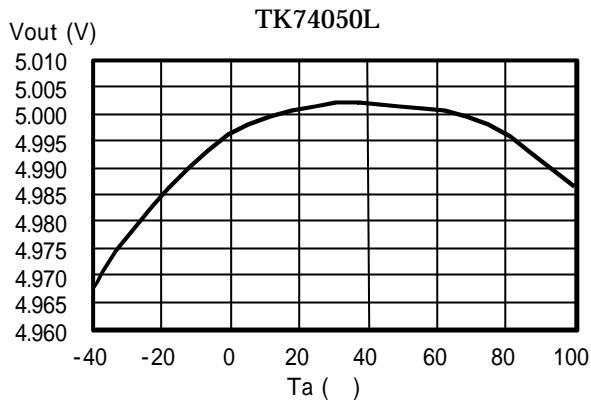

Application

Variable output voltage. Voltage control by an external voltage

When Vadj is raised more than 1.25V, the output voltage falls. Even only one side can be used.。

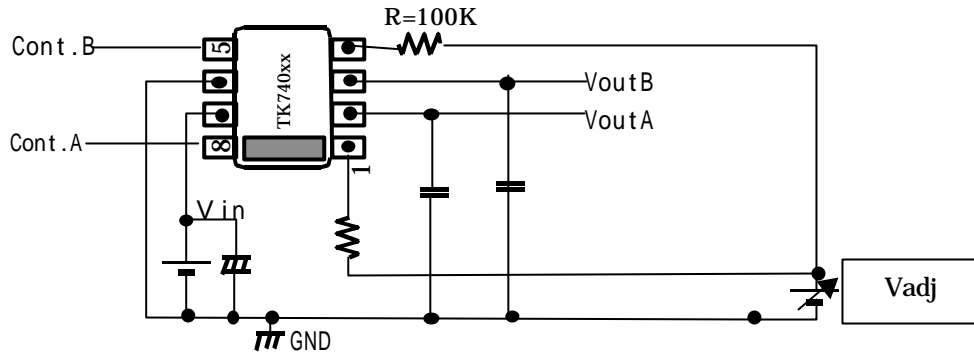

Forward or reversal: Motor drive circuit.

This connection becomes the bridge connection of NPN Tr 2 piece entering Digi-Tr (UMH10N and UMG8N, etc.) and combination PNP-Tr and NPN-Tr. The Motor can be driven by the low saturation type. Therefore, the stability operation is done up to the voltage with few I/O voltage differences. The voltage impressed to the motor comes in changeability. The I/O voltage difference of TK740xx is about 0.17V in $I_L=150mA$. The current when the motor starts is 300mA Max.

Please make to the logic, which becomes off once when the direction of the rotation is switched.

Constant speed (fixed voltage)

Even if the input voltage changes, the voltage impressed to the motor is constant.

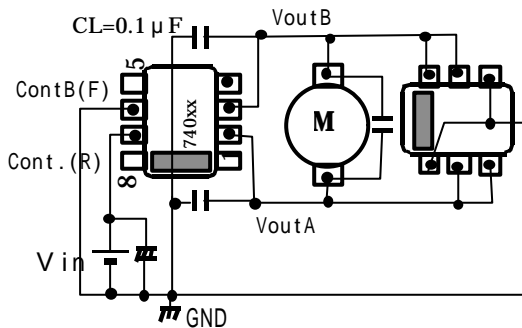

Variable speed (voltage changeability)

When Vadj is raised more than 1.25V, the output

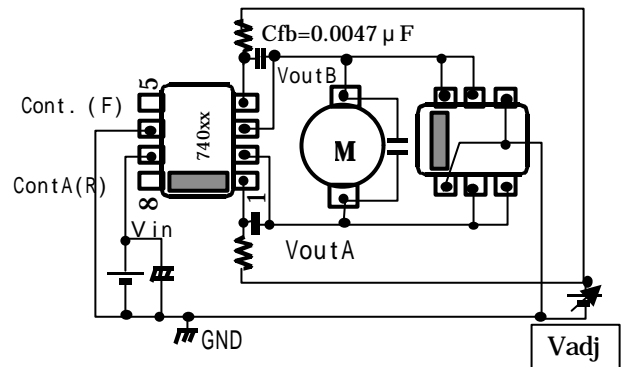

Layout Material : Grass epoxy 20 × 20mm t=0.8mm

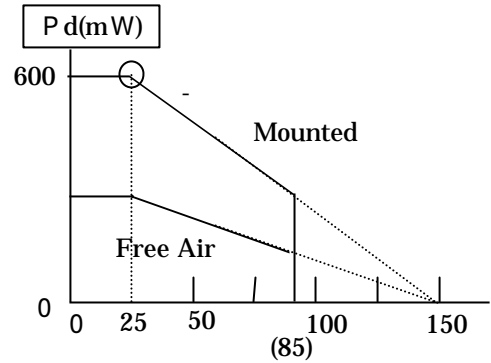
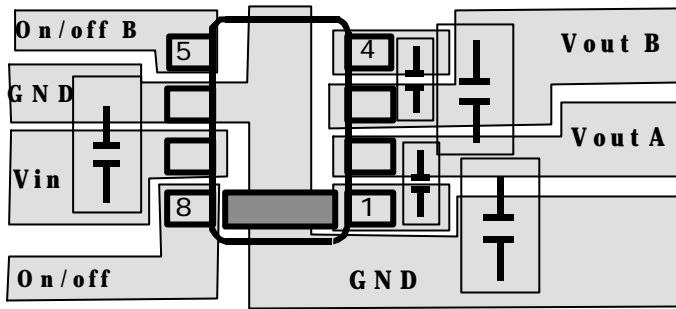

The heat loss is in total of A and B.

$P_d = 600 \text{ mW}$ when mounted as recommended. Derate at $4.8 \text{ mW}/^\circ\text{C}$ for operation above 25°C . The thermal resistance is $\theta_{ja} = 208 \text{ }^\circ\text{C}/\text{W}$. The package loss is limited at the temperature that the internal temperature sensor works (about 150°C). Therefore, the package loss is assumed to be an internal limitation. There is no heat radiation characteristic of the package unit assumed because of the small size. Heat is carried away by the device being installed on the PCB. This value changes by the material and the copper pattern etc. of the PCB. Enduring losses of about 500 mW becomes possible in a lot of applications operating at 25°C .

Determining the thermal resistance when mounted on a PCB.

The operating chip junction temperature is shown by

$$T_j = \theta_{ja} \times P_d + T_a \quad T_j \text{ of IC is set to about } 140^\circ\text{C}$$

P_d is a value when the over temperature sensor is made to work.

$$T_a (T_a = 25^\circ\text{C})$$

$$150 = \theta_{ja} \times P_d + 25$$

$$\theta_{ja} \times P_d = 125$$

$$\theta_{ja} = (125 / P_d) \text{ (}^\circ\text{C}/\text{mW)}$$

P_d is easily obtained.

Mount the IC on the PCB. P_d becomes $V_{in} \times I_{in}$ when the output side of the IC is short-circuited.

The input current decreases gradually by the temperature rise of the chip.

Please use the value when the current is steady (thermal equilibrium is reached).

In many cases, heat radiation is good, and P_d becomes 600 mW or more.

P_d is obtained by the normal temperature degrees. The current that can be used at the highest operating temperature is obtained from the graph of the figure below.

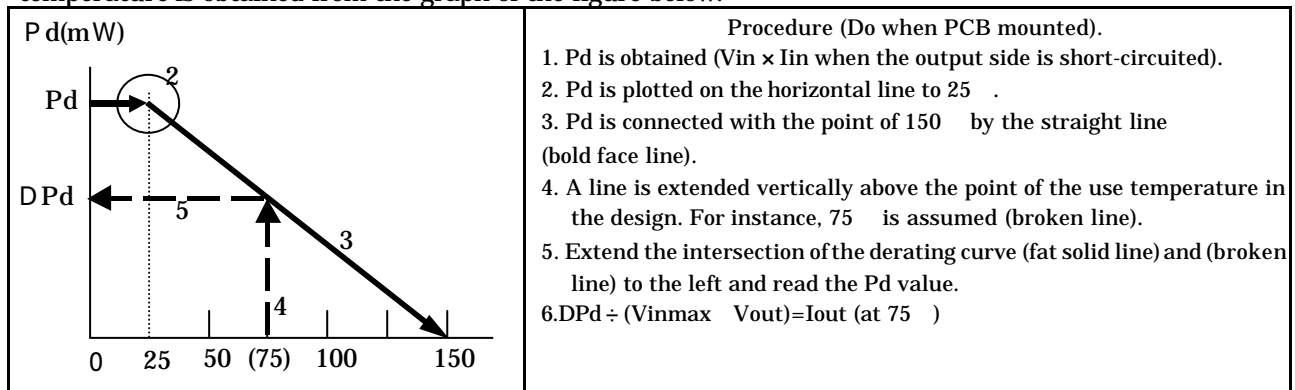

The maximum current that can be used at the highest operating temperature is:

$$I_{out} = DP_d \div (V_{inmax} - V_{out}).$$

When $(V_{inmax} - V_{out})$ is small, a lot of I_{out} is calculated. However, use that exceeds I_{outMax} cannot be done.

Application hint

On/off Control

It is recommended to turn the regulator Off when the circuit following the regulator is non-operating. A design with a little electric power loss can be implemented. We recommend the use of the on/off control of the regulator without using a high side switch to provide an output from the regulator. A highly accurate output voltage with low voltage drop is obtained.

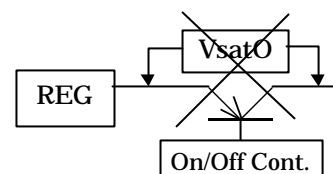

Because the control current is small, it is possible to control it directly by CMOS logic.

The PULLDOWN resistance is not built into the control terminal.

The noise and the ripple rejection characteristics depend on the capacitance between the V_{out} to the Fb terminal.

The IC will not be damaged if the capacitor value is increased.

Current boost

For current boost applications, use the products below. A low voltage drop, high current regulator can be easily made.

TK714xx Only the PNP transistor for the current boost is external.

TK732XX (For $I_{out}=10A$ Max regulator)

Built-in Short circuit protection: a constant current can be set by an external resistor.

Definition of Terms

The output voltage tables are specified with a test voltage of $V_{in} = \text{output voltage Typ} + 1V$.

Output Voltage (V_{out})

The output voltage is specified with $V_{in} = \text{output voltage Typ} + 1V$ and output current ($I_{out}=5mA$).

Maximum Output Current ($I_{out Max}$)

The output current is measured when the output voltage decreases to ($V_{out_{Typ}} \times 0.9$). The input voltage is (output voltage $\text{Typ} + 1V$). The maximum output current is measured in a short time so that it is not influenced by the temperature of the chip.

The output current decreases during low voltage operation.

Please refer to the "Low input voltage-output current" graph for 2.1V or less.

Dropout Voltage (V_{drop})

The dropout voltage is the difference between the input voltage and the output voltage at which point the regulator starts to fall out of regulation. Below this value, the output voltage will fall as the input voltage is reduced. It is dependent upon the load current (I_{out}) and the junction temperature (T_j).

The input voltage is gradually decreased below the test voltage. It is the voltage difference between the input and the output when the output voltage decreases by 100mV.

Line Regulation (Lin Reg)

Line regulation is the ability of the regulator to maintain a constant output voltage as the input voltage changes. The line regulation is specified as the input voltage is changed from (output voltage Typ+1V) to (output voltage Typ+6V). This measurement is not influenced by the temperature of the IC and is measured in a short time.

Load Regulation (Load Reg)

Load regulation is the ability of the regulator to maintain a constant output voltage as the load current changes. The input voltage is set to (output voltage Typ+1V). The output voltage change is measured as the load current changes from 5 to 100mA and from 5 to 200mA. This measurement is not influenced by the temperature of the IC and is measured in a short time.

Quiescent Current (Iq)

The quiescent current is the current which flows through the ground terminal under no load conditions (I_o=0 mA).

Ground Pin Current (I_{gnd})

The ground pin current is the current which flows through the GND terminal according to load current. It is measured by (input current-output current).

Ripple Rejection (RR)

Ripple rejection is the ability of the regulator to attenuate the ripple content of the input voltage at the output. It is specified with the input voltage = (V_{out} + 1.5V), I_o=10mA, C_L=1.0μF and C_{fb}=4700pF. An Alternating Current source of (f=1kHz and 200mV_{p-p}) is superimposed to the power-supply voltage. Ripple rejection is the ratio of the ripple content of the output vs. the input and is expressed in dB. It is typically about 84dB at 1kHz. The ripple rejection improves when the value of the capacitor at the noise bypass terminal in the circuit is large. However, the on/off response worsens.

Standby Current

Standby current is the current which flows into the regulator when the control voltage is made 0 volts. It is measured with an input voltage of 8V.

PROTECTION CIRCUITS**Short circuit Sensor**

This sensor operates when there is excessive output current. The short circuit sensor protects the device if the output is accidentally shorted to GND. The current flows at the set peak value.

Thermal Sensor

The thermal sensor protects the device if the junction temperature exceeds the safe value (T_j=150 °C). This temperature rise can be caused by extreme heat, excessive power dissipation caused by large output voltage drops, or excessive output current. The regulator will shut off when the temperature exceeds the safe value. As the junction temperature decreases, the regulator will begin to operate again. Under sustained fault conditions, the regulator output will oscillate as the device turns off then resets. Please improve heat radiation or lower the input electric power. When heat radiation is poor, the forecast package loss is not obtained.

ESD	MM	200pF	0	200V Min
	HBM	100pF	1.5k	2000V Min

Package outline /Stamps

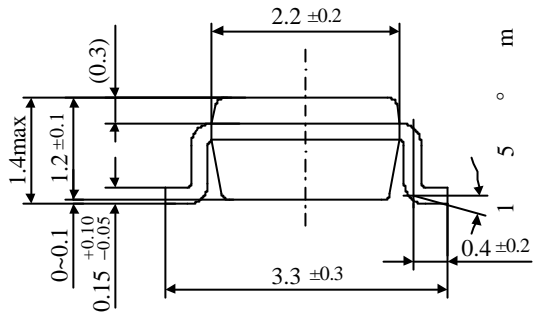
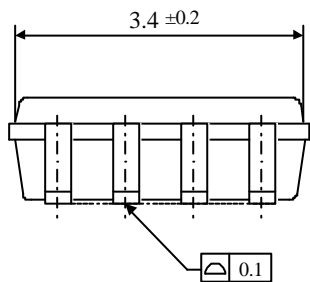
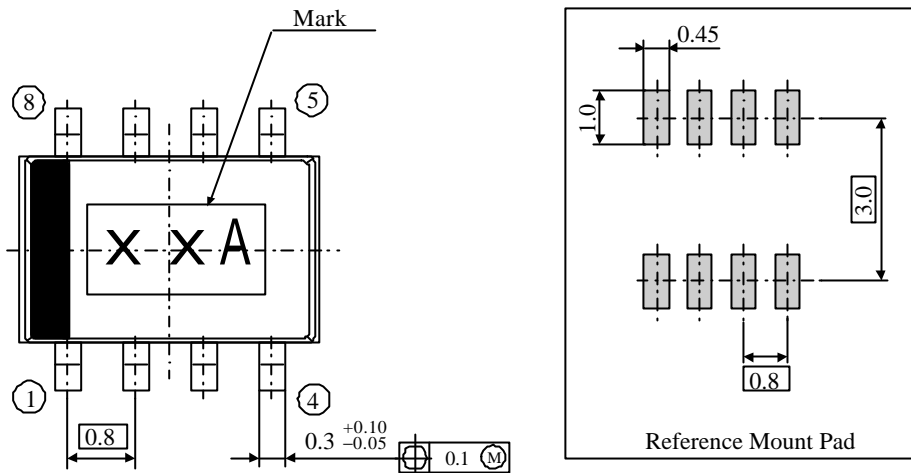

Unit : mm

Package Structure

Package Material : Epoxy Resin
 Terminal Material : Copper Alloy
 Mass (Reference) : 0.024g

Vout	Mark	Vout	Mark	Vout	Mark	Vout	Mark
		2.1 V	21A	3.1 V	31A	4.1 V	41A
		2.2	22A	3.2	32A	4.2	42A
1.3 V	13A	2.3	23A	3.3	33A	4.3	43A
1.4	14A	2.4	24A	3.4	34A	4.4	44A
1.5	15A	2.5	25A	3.5	35A	4.5	45A
1.6	16A	2.6	26A	3.6	36A	4.6	46A
1.7	17A	2.7	27A	3.7	37A	4.7	47A
1.8	18A	2.8	28A	3.8	38A	4.8	48A
1.9	19A	2.9	29A	3.9	39A	4.9	49A
2.0	20A	3.0	30A	4.0	40A	5.0	50A

The output voltage table indicates the standard value when manufactured.

NOTE

Please be sure that you carefully discuss your planned purchase with our office if you intend to use the products in this data sheet under conditions where particularly extreme standards of reliability are required, or if you intend to use products for applications other than those listed in this data sheet.

- Power drive products for automobile, ship or aircraft transport systems; steering and navigation systems, emergency signal communications systems, and any system other than those mentioned above which include electronic sensors, measuring, or display devices, and which could cause major damage to life, limb or property if misused or failure to function.
 - Medical devices for measuring blood pressure, pulse, etc., treatment units such as coronary pacemakers and heat treatment units, and devices such as artificial organs and artificial limb systems which augment physiological functions.
 - Electrical instruments, equipment or systems used in disaster or crime prevention.
- Semiconductors, by nature, may fail or malfunction in spite of our devotion to improve product quality and reliability. We urge you to take every possible precaution against physical injuries, fire or other damages which may cause failure of our semiconductor products by taking appropriate measures, including a reasonable safety margin, malfunction preventive practices and fire-proofing when designing your products.
 - This data sheet is effective from May, 2002. Note that the contents are subject to change or discontinuation without notice. When placing orders, please confirm specifications and delivery condition in writing.
 - TOKO is not responsible for any problems nor for any infringement of third party patents or any other intellectual property rights that may arise from the use or method of use of the products listed in this data sheet. Moreover, this data sheet does not signify that TOKO agrees implicitly or explicitly to license any patent rights or other intellectual property rights which it holds.
 - None of ozone depleting substances(ODS) under the Montreal Protocol is used in manufacturing process of us.

If you need more information on this product and other TOKO products, please contact us.

OFFICE

■ TOKO Inc. Headquarters

1-17, Higashi-yukigaya 2-chome, Ohta-ku, Tokyo,145-8585, Japan

TEL: +81.3.3727.1161

FAX: +81.3.3727.1176 or +81.3.3727.1169

Web site: <http://www.toko.co.jp/>

■ TOKO America

Web site: <http://www.toko.com/>

■ TOKO Europe

Web site: <http://www.tokoeurope.com/>

■ TOKO Hong Kong

Web site: <http://www.toko.com.hk/>

■ TOKO Taiwan

Web site: <http://www.tokohc.com.tw/>

■ TOKO Singapore

Web site: <http://www.toko.com.sg/>

■ TOKO Seoul

Web site: <http://www.toko.co.kr/>

■ TOKO Manila

Web site: <http://www.toko.com.ph/>

■ TOKO Brazil

Web site: <http://www.toko.com.br/>



TO BUILD THE QUALITY RELIED BY COSTOMERS
Semiconductor Division

YOUR DISTRIBUTOR