

ESD / SURGE PROTECTORS



Faxback Document #1418

• RCCA SERIES

- Protection From Electrostatic Surge
- Surface Mounted Gas Arrester
- IEC-61000-4-2
- Micro-Gap Design
- Applications:
 - Antenna Protection,
 - Telecom, xBaseT, Hub Protection
 - Security Systems
 - Data Acquisition
 - Audio Systems

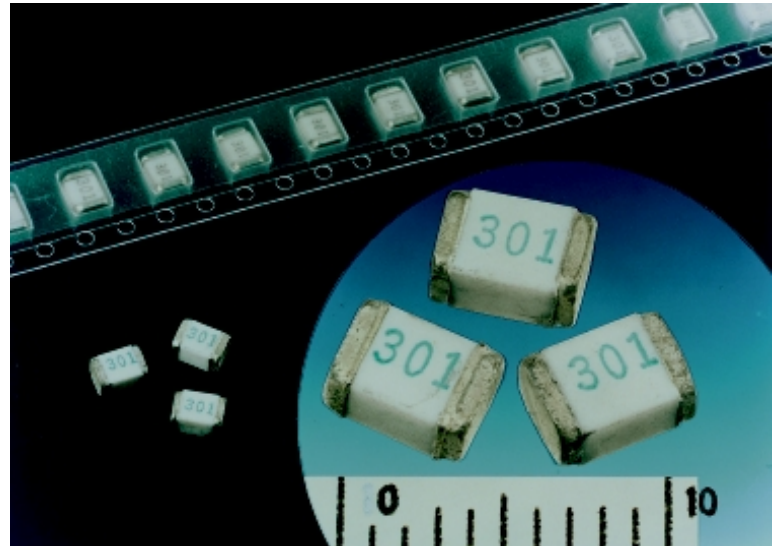

Temperature vs DC Breakdown Voltage

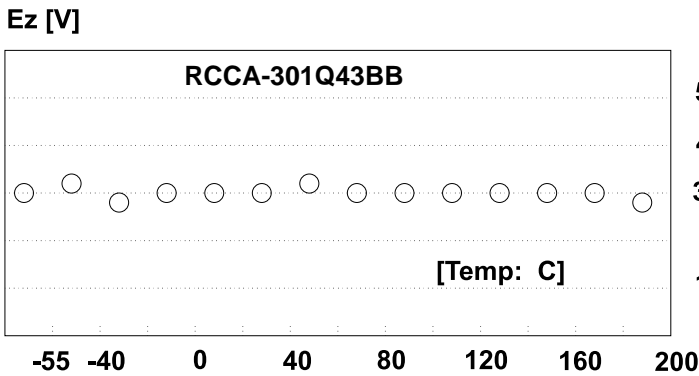

Life Test DC Breakdown Voltage

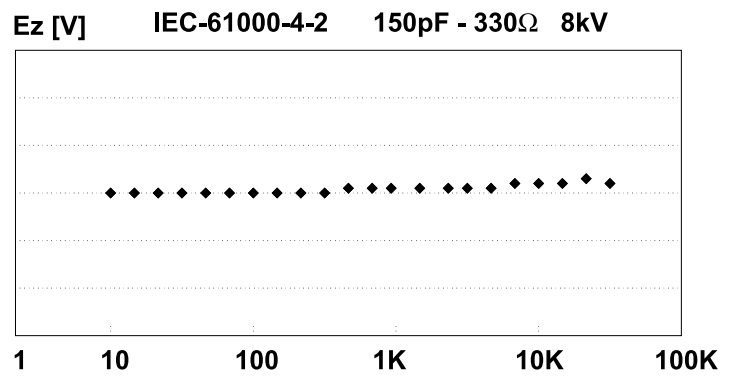

Electrical Specifications

Model RCCA	Breakdown Voltage DC	Insulation Resistance	Electrostatic Capacitance	Surge Current Capacity	Electrostatic Surge Life IEC-61000-4-2	Surge Life Test
-201Q43BB	200V(140~260)	100Mohm (min.)	1pF Max.	1000 Amp	150pF-330ohm 8kV 3000 Times	500pF-0ohm 15kV 200 Times
-301Q43BB	300V(210~390)					
-401Q43BB	400V(280~520)					

ESD / SURGE PROTECTORS

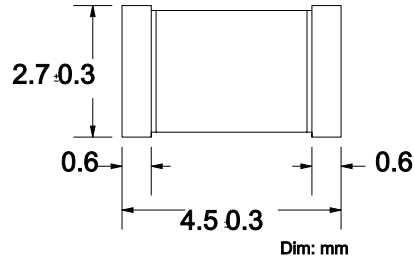
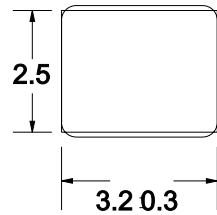

Temperature vs DC Breakdown Voltage

Life Test DC Breakdown Voltage

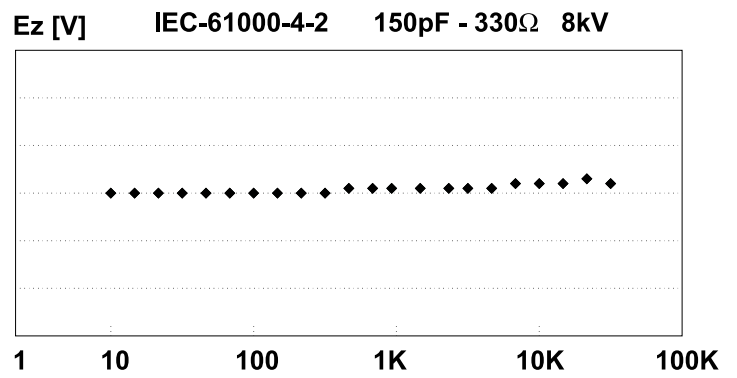
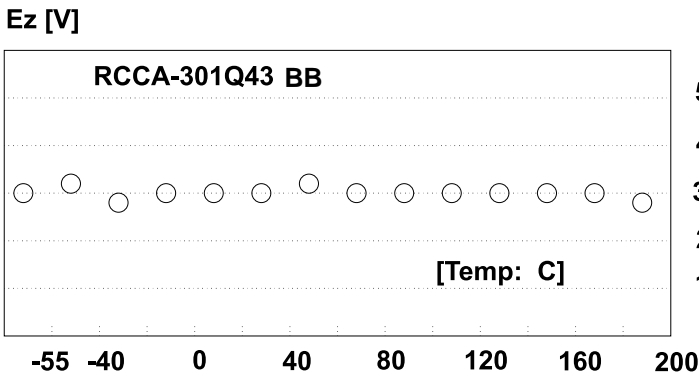

Reel Dimensioning

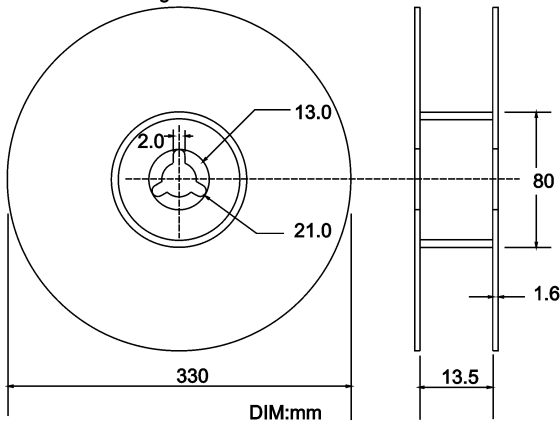

Tape Dimensioning

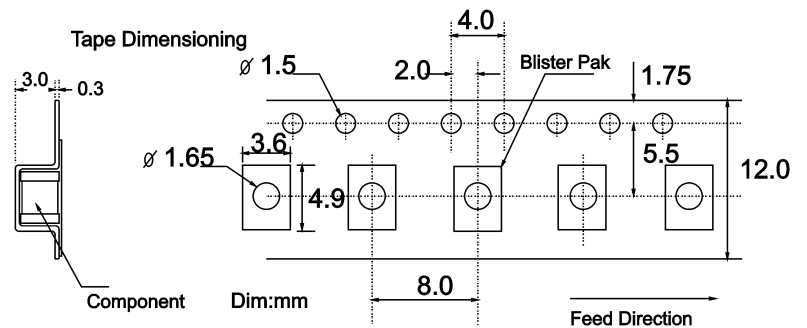

www.okaya.com

Okaya Electric America Inc.



503 Wall Street, Valparaiso, Indiana 46383
 Ph: 219-477-4488 / Fax: 219-477-4856