

### Designation System:

- CA = **C**hip **A**rray  
 06 = Dimensions of the device **06**x12 (Length x width in 1/100 inch)  
 P = Design (**P**arallel internal structure)  
 4 = Number of elements  
 S...A = **S**pecial tolerance **A** of the varistor voltage  
 17 = Max. operating voltage  
 LC = **L**ow **C**apacitance  
 G = Taped version (blister tape, 7" reel, 3000 pieces/reel)  
 K2 = Silver-platinum termination (Ag/Pt)

### Figure:

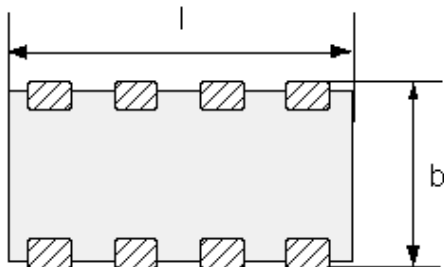

$$\begin{aligned}
 l &= 3,2 \pm 0,2 \\
 b &= 1,6 \pm 0,15 \\
 s &= 0,9 \text{ max.} \\
 d &= 0,4 \pm 0,15 \\
 e &= 0,76 \pm 0,15
 \end{aligned}$$

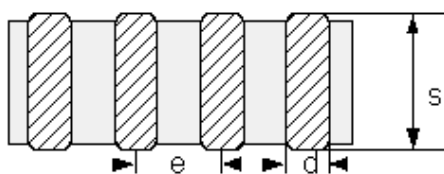

Coplanarity < 0.1

(All dimensions in mm)

As far as patents or other rights of third parties are concerned, liability is only assumed for components per se, not for applications, processes and circuits implemented within components or assemblies. The information describes the type of component and shall not be considered as assured characteristics. Terms of delivery and rights to change design reserved.

ISSUE DATE	12.07.02	ISSUE	e	PUBLISHER	KB VS PE	PAGE	1/6
------------	----------	-------	---	-----------	----------	------	-----

**V-I-Characteristic:**

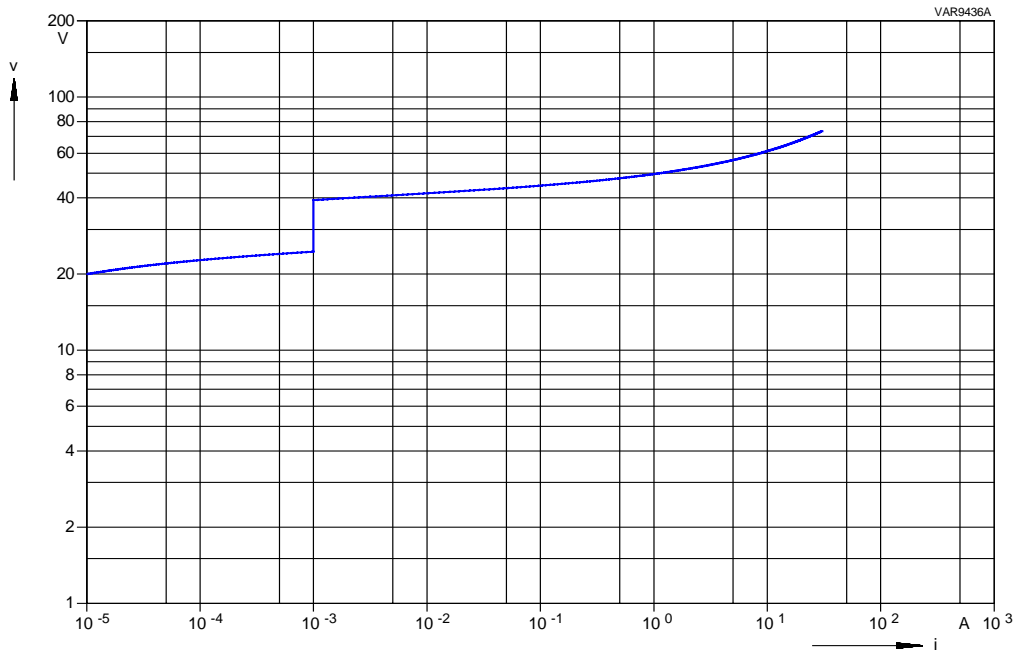

**Derating Field:**

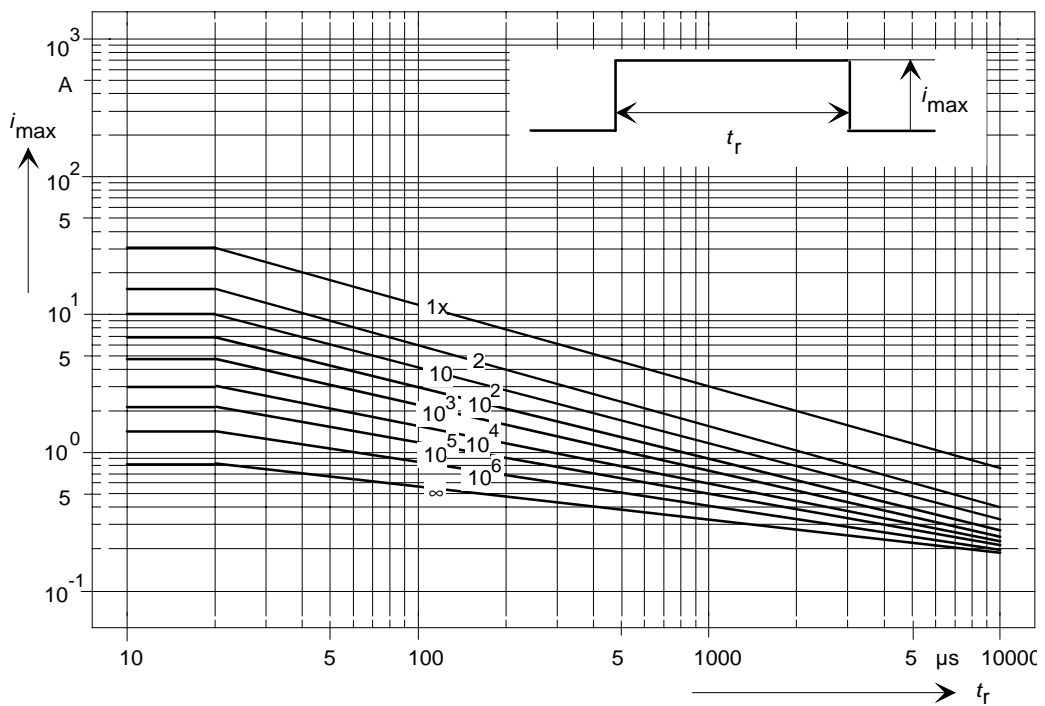



### Electrical Data

Max. operating voltage

RMS voltage

$V_{eff} = 17 \text{ V}$

DC voltage

$V_{DC} = 22 \text{ V}$

Varistor voltage (@ 1 mA)

$V_V = 25 - 40 \text{ V}$

Max. clamping voltage (@ 1 A)

$V_C = 50 \text{ V}$

Max. average power dissipation

$P_{max} = 3 \text{ mW}$

Max. surge current (8/20  $\mu\text{s}$ )

$\hat{I}_{max} = 1 \times 30 \text{ A}$

Max. energy absorption (2 ms)

$E_{max} = 1 \times 0.075 \text{ J}$

Capacitance (@ 1MHz, 0.5 V)

$< 75 \text{ pF}$

Response time

$< 0.5 \text{ ns}$

Operating temperature

$-30 \dots +85 \text{ }^\circ\text{C}$

Storage temperature (mounted parts)

$-40 \dots +125 \text{ }^\circ\text{C}$

Termination material

AgPt

(thickness not specified, adjusted to fulfill wettability specification acc. to IEC 60068-2-58)

Part weight

0.02 g

Max. current, energy, operating voltage and average depending on ambient temperature

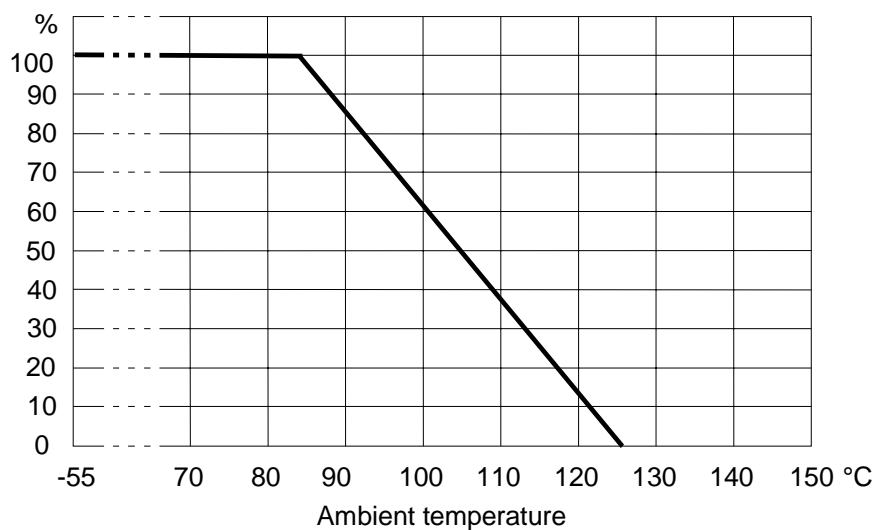

### Recommended Geometry of Solder Pads

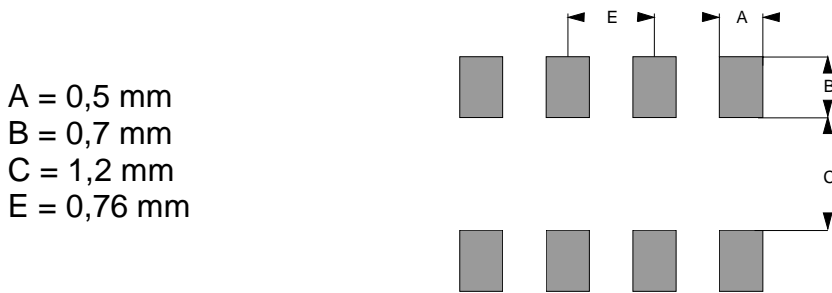

A = 0,5 mm  
 B = 0,7 mm  
 C = 1,2 mm  
 E = 0,76 mm

### Recommended Soldering Temperature Profiles

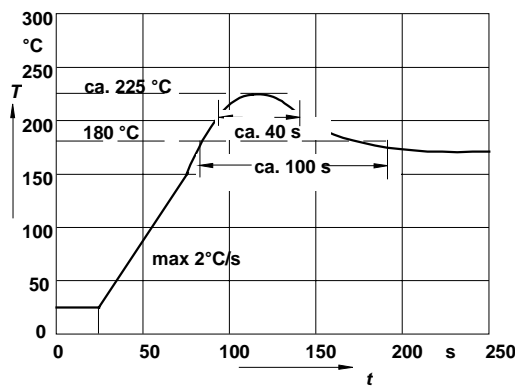

This component is only suited for IR-soldering at relatively low temperatures and must not be wave soldered because of dissolution of the metallization!

Max. reflow temperature: 235° C, 30 sec  
 220° C, 45 sec.  
 Max. reflow cycles: 2 x .

As far as possible, the components shall be employed within 6 months. They should be left in their original packings to avoid soldering problems due to oxidized contacts.

Storage temperature: -25 to 45°C

Relative humidity: <75% annual average, <95% on max. 30 days in a year.

The usage of mild, non activated fluxes for soldering is recommended, as well as a proper cleaning of the PCB.

ISSUE DATE	12.07.02	ISSUE	e	PUBLISHER	KB VS PE	PAGE	4/6
------------	----------	-------	---	-----------	----------	------	-----

**Taping According to IEC 60286-3**

Dimensions and tolerances

Tape material: plastic embossed

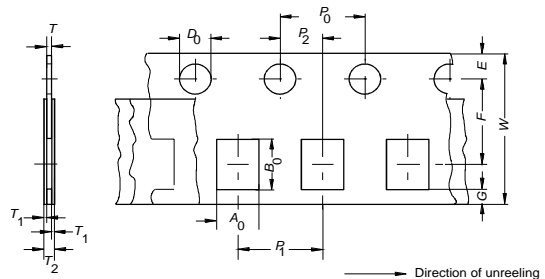

Definition	Symbol	Dim.	Tolerance
Compartment width	A <sub>0</sub>	1.9	± 0.2
Compartment length	B <sub>0</sub>	3.5	± 0.2
Compartment height	K <sub>0</sub>	1.3	max.
Sprocket hole diameter	D <sub>0</sub>	1.5	+0.1 /-0
Compartment hole diameter	D <sub>1</sub>	1.0	min.
Sprocket hole pitch	P <sub>0</sub>	4.0	± 0.1 <sup>1)</sup>
Distance center hole to center compartment	P <sub>2</sub>	2.0	± 0.05
Pitch of the component compartments	P <sub>1</sub>	4.0	± 0.1
Tape width	W	8.0	± 0.3
Distance edge to center of hole	E	1.75	± 0.1
Distance center hole to center compartment	F	3.5	± 0.05
Overall thickness	T <sub>2</sub>	2.5	max.

<sup>1)</sup> ≤ ± 0.2 mm over any 10 pitches

Tape end (trailer)

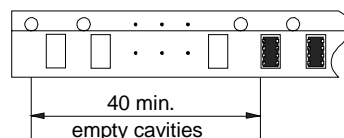

Leader

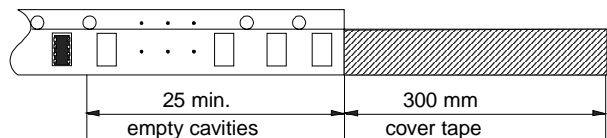

Data sheet

## Package

Each reel in airtight plastic bag with desiccant bag.  
Dimensions approx. 220 x 200 mm.

Package: 8 mm tape

Reel material: plastic

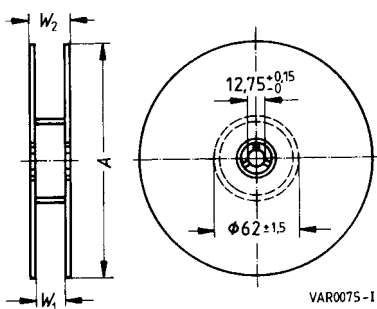

Definition	Symbol	Dim.	Tol.
Reel diameter	A	180	-2
Reel width (inside)	$W_1$	8.4	+1.5 /-0
Reel width (outside)	$W_2$	14.4	max.

© EPCOS AG 2002. Reproduction, publication and dissemination of this data sheet, enclosures hereto and the information contained therein without EPCOS' prior express consent is prohibited.

Purchase orders are subject to the General Conditions for the Supply of Products and Services of the Electrical and Electronics Industry recommended by the ZVEI (German Electrical and Electronic Manufacturers' Association), unless otherwise agreed.

ISSUE DATE	12.07.02	ISSUE	e	PUBLISHER	KB VS PE	PAGE	6/6
------------	----------	-------	---	-----------	----------	------	-----