

ELM99xxxxxxBW CMOS Middle current dual voltage regulator

■ General description

ELM99xxxxxxBW is CMOS dual voltage regulator providing large current which contains 2 ELM99 series ICs. It consists of 2 sets of reference voltage source, error amplifier, low resistance output transistor, short-circuit protection circuit, output voltage setting resistor and chip-enable circuit. ELM99W series is characterized with small input/output voltage difference (with its low resistance output transistor) and high load stability (with its high gain error amplifier). There are 3 types of CE selection of ELM99W series: non-chip enable function, "L" active and "H" active. The standard output voltages are 2.7V, 3.0V, 3.3V, 5.0V; ELM99W can also be made as semi-custom IC within the range of 1.5V~6.0V by 0.1V step.

■ Features

- Output voltage range : 1.5V~6.0V (by 0.1V)
- Max. output current : 300mA
(Internal current limiter operates when the current exceeds 300mA)
- Stand-by current consumption : Typ. 0.1 μ A ("H" active)
- Input stability : Typ. 0.15%/V ($V_{out}=3.0V$, $I_{out}=40mA$)
- Load stability : Typ. 5mV ($1mA \leq I_{out} \leq 100mA$)
- Accuracy of output voltage : $\pm 2.0\%$
- Input/Output voltage differential : Typ. 140mV ($V_{out}=3.0V$, $I_{out}=40mA$)
- Short-circuit current limiter : Typ. 70mA ($V_{out}=0V$)
- Chip-enable pin : "L" active
"H" active
- Package : TSSOP-8

■ Application

- Battery operated devices
- Digital cameras
- Video recorders
- Reference voltage source
- Cell phones

■ Maximum absolute ratings

Parameter	Symbol	Limit	Unit
Input voltage	V_{in}	12	V
CE/CE Input voltage	V_{ce}	$V_{ss}-0.3 \sim V_{in}+0.3$	V
Output voltage	V_{out}	$V_{ss}-0.3 \sim V_{in}+0.3$	V
Output current	I_{out}	500	mA
Power dissipation	P_d	300	mW
Operating temperature	T_{op}	-40~+85	$^{\circ}C$
Storage temperature	T_{stg}	-55~+125	$^{\circ}C$

*Output current must not exceed power dissipation specified in maximum absolute ratings.

■ Selection guide

ELM99xxxxxBW-x

Symbol		
a,b	Output voltage	e.g. : 27:Vout=2.7V 30:Vout=3.0V 33:Vout=3.3V 50:Vout=5.0V
c	CE selection	1 : No CE 2 : \overline{CE} ="L" active 3 : CE="H" active
d,e	Output voltage	e.g. : 27:Vout=2.7V 30:Vout=3.0V 33:Vout=3.3V 50:Vout=5.0V
f	CE selection	1 : No CE 2 : \overline{CE} ="L" active 3 : CE="H" active
g	Product version	B
h	Dual mark	W: dual
i	Taping direction	S : Refer to PKG file N : Refer to PKG file

ELM99 x x x x x x B W - x
 ↑ ↑ ↑ ↑ ↑ ↑ ↑ ↑ ↑
 a b c d e f g h i

■ Pin configuration

TSSOP-8 (TOP VIEW)

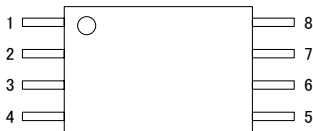

Pin No.	Pin name
1	CE1 or NC
2	VSS1
3	VIN
4	VOUT1
5	VOUT2
6	VSS2
7	CE2 or NC
8	VIN

* : Pin NO.1 or NO.7 is NC if ELM99xx1B is included in the combination.

■ Standard circuit

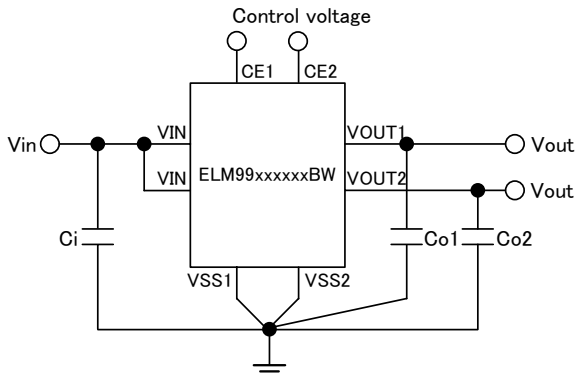

* : CE1, CE2:
No connection if IC has no CE function Low or High active if IC has CE function

■ Block diagram

No CE unit

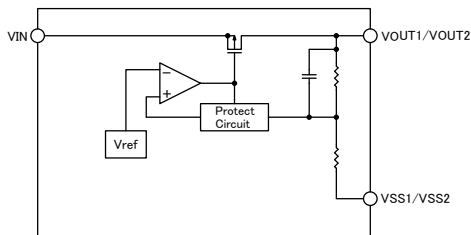

CE available unit

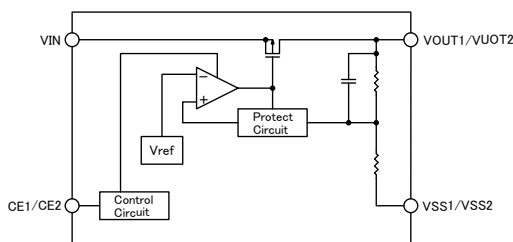

(This IC consists of two above-mentioned ICs)

■ Electrical characteristics (ELM99xx1xx1BW)

Vout=2.7V, No CE pin

Top=25°C

Parameter	Symbol	Condition	Min.	Typ.	Max.	Unit
Output voltage	Vout	Vin=3.7V, Iout=40mA	2.646	2.700	2.754	V
Output current	Iout	Vin=3.7V, Lower by 0.1V than Vout	150	260		mA
Input stability	$\Delta V_{out} / \Delta V_{in}$	Iout=40mA, 3.7V ≤ Vin ≤ 8.0V		0.15	0.30	%/V
Load stability	$\Delta V_{out} / \Delta I_{out}$	1mA ≤ Iout ≤ 100mA, Vin=3.7V		5	15	mV
Input/output voltage differential	Vdif	Iout=40mA		190	320	mV
Current consumption	Iss	Vin=3.7V, No-load		25	45	μA
Input voltage	Vin				8	V
Output voltage temperature coefficient	$\Delta V_{out} / \Delta T_{op}$	Vin=3.7V, Iout=40mA, -40°C ≤ Top ≤ +85°C		±100		ppm/°C
Short circuit current	Ilim	Vout=0V		70		mA

ELM99xxxxxxBW CMOS Middle current dual voltage regulator

Vout=3.0V, No CE pin

Top=25°C

Parameter	Symbol	Condition	Min.	Typ.	Max.	Unit
Output voltage	Vout	Vin=4.0V, Iout=40mA	2.940	3.000	3.060	V
Output current	Iout	Vin=4.0V, Lower by 0.1V than Vout	160	290		mA
Input stability	$\Delta V_{out} / \Delta V_{in}$	Iout=40mA, 4.0V \leq Vin \leq 8.0V		0.15	0.30	%/V
Load stability	$\Delta V_{out} / \Delta I_{out}$	1mA \leq Iout \leq 100mA, Vin=4.0V		5	15	mV
Input/output voltage differential	Vdif	Iout=40mA		170	280	mV
Current consumption	Iss	Vin=4.0V, No-load		25	45	μ A
Input voltage	Vin				8	V
Output voltage temperature coefficient	$\Delta V_{out} / \Delta T_{op}$	Vin=4.0V, Iout=40mA, -40°C \leq Top \leq +85°C		\pm 100		ppm/°C
Short circuit current	Ilim	Vout=0V		70		mA

Vout=3.3V, No CE pin

Top=25°C

Parameter	Symbol	Condition	Min.	Typ.	Max.	Unit
Output voltage	Vout	Vin=4.3V, Iout=40mA	3.234	3.300	3.366	V
Output current	Iout	Vin=4.3V, Lower by 0.1V than Vout	170	300		mA
Input stability	$\Delta V_{out} / \Delta V_{in}$	Iout=40mA, 4.3V \leq Vin \leq 8.0V		0.15	0.30	%/V
Load stability	$\Delta V_{out} / \Delta I_{out}$	1mA \leq Iout \leq 100mA, Vin=4.3V		5	15	mV
Input/output voltage differential	Vdif	Iout=40mA		150	265	mV
Current consumption	Iss	Vin=4.3V, No-load		25	45	μ A
Input voltage	Vin				8	V
Output voltage temperature coefficient	$\Delta V_{out} / \Delta T_{op}$	Vin=4.3V, Iout=40mA, -40°C \leq Top \leq +85°C		\pm 100		ppm/°C
Short circuit current	Ilim	Vout=0V		70		mA

Vout=5.0V, No CE pin

Top=25°C

Parameter	Symbol	Condition	Min.	Typ.	Max.	Unit
Output voltage	Vout	Vin=6.0V, Iout=4mA	4.900	5.000	5.100	V
Output current	Iout	Vin=6.0V, Lower by 0.1V than Vout	200	330		mA
Input stability	$\Delta V_{out} / \Delta V_{in}$	Iout=40mA, 6.0V \leq Vin \leq 8.0V		0.15	0.30	%/V
Load stability	$\Delta V_{out} / \Delta I_{out}$	1mA \leq Iout \leq 100mA, Vin=6.0V		5	15	mV
Input/output voltage differential	Vdif	Iout=40mA		125	220	mV
Current consumption	Iss	Vin=6.0V, No-load		30	55	μ A
Input voltage	Vin				8	V
Output voltage temperature coefficient	$\Delta V_{out} / \Delta T_{op}$	Vin=6.0V, Iout=40mA, -40°C \leq Top \leq +85°C		\pm 100		ppm/°C
Short circuit current	Ilim	Vout=0V		70		mA

■ Electrical characteristics (ELM99xx2xx2BW)

$V_{out}=2.7V$, \overline{CE} ="L" active

$T_{op}=25^{\circ}C$

Parameter	Symbol	Condition	Min.	Typ.	Max.	Unit
Output voltage	V_{out}	$V_{in}=3.7V$, $I_{out}=40mA$	2.646	2.700	2.754	V
Output current	I_{out}	$V_{in}=3.7V$, Lower by 0.1V than V_{out}	150	260		mA
Input stability	$\Delta V_{out} / \Delta V_{in}$	$I_{out}=40mA$, $3.7V \leq V_{in} \leq 8.0V$		0.15	0.30	%/V
Load stability	$\Delta V_{out} / \Delta I_{out}$	$1mA \leq I_{out} \leq 100mA$, $V_{in}=3.7V$		5	15	mV
Input/output voltage differential	V_{dif}	$I_{out}=40mA$		190	320	mV
Current consumption	I_{ss}	$V_{in}=3.7V$		25	45	μA
Stand-by current consumption	$I_{standby}$	$V_{in}=V_{ce}=3.7V$		0.005	0.100	μA
Input voltage	V_{in}				8	V
\overline{CE} Input voltage High	V_{ceh}	$V_{in}=8.0V$	1.80		V_{in}	V
\overline{CE} Input voltage Low	V_{cel}	$V_{in}=2.0V$	0.00		0.25	V
\overline{CE} Input current High	I_{ceh}	$V_{ce}=V_{in}$		0.0	0.2	μA
\overline{CE} Input current Low	I_{cel}	$V_{ce}=V_{ss}$	-1.5	-0.4		
Output voltage temperature coefficient	$\Delta V_{out} / \Delta T_{op}$	$V_{in}=3.7V$, $I_{out}=40mA$, $-40^{\circ}C \leq T_{op} \leq +85^{\circ}C$		± 100		ppm/ $^{\circ}C$
Short circuit current	I_{lim}	$V_{out}=0V$		70		mA

$V_{out}=3.0V$, \overline{CE} ="L" active

$T_{op}=25^{\circ}C$

Parameter	Symbol	Condition	Min.	Typ.	Max.	Unit
Output voltage	V_{out}	$V_{in}=4.0V$, $I_{out}=40mA$	2.940	3.000	3.060	V
Output current	I_{out}	$V_{in}=4.0V$, Lower by 0.1V than V_{out}	160	290		mA
Input stability	$\Delta V_{out} / \Delta V_{in}$	$I_{out}=40mA$, $4.0V \leq V_{in} \leq 8.0V$		0.15	0.30	%/V
Load stability	$\Delta V_{out} / \Delta I_{out}$	$1mA \leq I_{out} \leq 100mA$, $V_{in}=4.0V$		5	15	mV
Input/output voltage differential	V_{dif}	$I_{out}=40mA$		170	280	mV
Current consumption	I_{ss}	$V_{in}=4.0V$		25	45	μA
Stand-by current consumption	$I_{standby}$	$V_{in}=V_{ce}=4.0V$		0.005	0.100	μA
Input voltage	V_{in}				8	V
\overline{CE} Input voltage High	V_{ceh}	$V_{in}=8.0V$	1.80		V_{in}	V
\overline{CE} Input voltage Low	V_{cel}	$V_{in}=2.0V$	0.00		0.25	V
\overline{CE} Input current High	I_{ceh}	$V_{ce}=V_{in}$		0.0	0.2	μA
\overline{CE} Input current Low	I_{cel}	$V_{ce}=V_{ss}$	-1.5	-0.4		
Output voltage temperature coefficient	$\Delta V_{out} / \Delta T_{op}$	$-40^{\circ}C \leq T_{op} \leq +85^{\circ}C$, $V_{in}=4.0V$, $I_{out}=40mA$		± 100		ppm/ $^{\circ}C$
Short circuit current	I_{lim}	$V_{out}=0V$		70		mA

ELM99xxxxxxBW CMOS Middle current dual voltage regulator

Vout=3.3V, \overline{CE} ="L" active

Top=25°C

Parameter	Symbol	Condition	Min.	Typ.	Max.	Unit
Output voltage	Vout	Vin=4.3V, Iout=40mA	3.234	3.300	3.366	V
Output current	Iout	Vin=4.3V, Lower by 0.1V than Vout	170	300		mA
Input stability	$\Delta V_{out} / \Delta V_{in}$	Iout=40mA, 4.3V ≤ Vin ≤ 8.0V		0.15	0.30	%/V
Load stability	$\Delta V_{out} / \Delta I_{out}$	1mA ≤ Iout ≤ 100mA, Vin=4.3V		5	15	mV
Input/output voltage differential	Vdif	Iout=40mA		150	265	mV
Current consumption	I _{ss}	Vin=4.3V		25	45	μA
Stand-by current consumption	I _{standby}	Vin=Vce=4.3V		0.005	0.100	μA
Input voltage	Vin				8	V
\overline{CE} Input voltage High	Vceh	Vin=8.0V	1.80		Vin	V
\overline{CE} Input voltage Low	Vcel	Vin=2.0V	0.00		0.25	V
\overline{CE} Input current High	Iceh	Vce=Vin		0.0	0.2	μA
\overline{CE} Input current Low	Icel	Vce=Vss	-1.5	-0.4		
Output voltage temperature coefficient	$\Delta V_{out} / \Delta T_{op}$	-40°C ≤ Top ≤ +85°C, Vin=4.3V, Iout=40mA		±100		ppm/°C
Short circuit current	I _{lim}	Vout=0V		70		mA

Vout=5.0V, \overline{CE} ="L" active

Top=25°C

Parameter	Symbol	Condition	Min.	Typ.	Max.	Unit
Output voltage	Vout	Vin=6.0V, Iout=40mA	4.900	5.000	5.100	V
Output current	Iout	Vin=6.0V, Lower by 0.1V than Vout	200	330		mA
Input stability	$\Delta V_{out} / \Delta V_{in}$	Iout=40mA, 6.0V ≤ Vin ≤ 8.0V		0.15	0.30	%/V
Load stability	$\Delta V_{out} / \Delta I_{out}$	1mA ≤ Iout ≤ 100mA, Vin=6.0V		5	15	mV
Input/output voltage differential	Vdif	Iout=40mA		125	220	mV
Current consumption	I _{ss}	Vin=6.0V		30	55	μA
Stand-by current consumption	I _{standby}	Vin=Vce=6.0V		0.005	0.100	μA
Input voltage	Vin				8	V
\overline{CE} Input voltage High	Vceh	Vin=8.0V	1.80		Vin	V
\overline{CE} Input voltage Low	Vcel	Vin=2.0V	0.00		0.25	V
\overline{CE} Input current High	Iceh	Vce=Vin		0.0	0.2	μA
\overline{CE} Input current Low	Icel	Vce=Vss	-1.5	-0.4		
Output voltage temperature coefficient	$\Delta V_{out} / \Delta T_{op}$	-40°C ≤ Top ≤ +85°C, Vin=6.0V, Iout=40mA		±100		ppm/°C
Short circuit current	I _{lim}	Vout=0V		70		mA

ELM99xxxxx3BW CMOS Middle current dual voltage regulator

■ Electrical characteristics (ELM99xx3xx3BW)

Vout=2.7V, CE="H" active

Top=25°C

Parameter	Symbol	Condition	Min.	Typ.	Max.	Unit
Output voltage	Vout	Vin=3.7V, Iout=40mA	2.646	2.700	2.754	V
Output current	Iout	Vin=3.7V, Lower by 0.1V than Vout	150	260		mA
Input stability	$\Delta V_{out} / \Delta V_{in}$	Iout=40mA, 3.7V ≤ Vin ≤ 8.0V		0.15	0.30	%/V
Load stability	$\Delta V_{out} / \Delta I_{out}$	1mA ≤ Iout ≤ 100mA, Vin=3.7V		5	15	mV
Input/output voltage differential	Vdif	Iout=40mA		190	320	mV
Current consumption	I _{ss}	Vin=3.7V		25	45	μA
Stand-by current consumption	I _{standby}	Vin=3.7V, Vce=Vss		0.1	0.5	μA
Input voltage	Vin				8	V
CE Input voltage High	Vceh	Vin=8.0V	1.80		Vin	V
CE Input voltage Low	Vcel	Vin=2.0V	0.00		0.25	V
CE Input current High	Iceh	Vce=Vin		0.4	1.5	μA
CE Input current Low	Icel	Vce=Vss	-0.2	0.0		
Output voltage temperature coefficient	$\Delta V_{out} / \Delta T_{op}$	-40°C ≤ Top ≤ +85°C, Vin=3.7V, Iout=40mA		±100		ppm/°C
Short circuit current	I _{lim}	Vout=0V		70		mA

Vout=3.0V, CE="H" active

Top=25°C

Parameter	Symbol	Condition	Min.	Typ.	Max.	Unit
Output voltage	Vout	Vin=4.0V, Iout=40mA	2.940	3.000	3.060	V
Output current	Iout	Vin=4.0V, Lower by 0.1V than Vout	160	290		mA
Input stability	$\Delta V_{out} / \Delta V_{in}$	Iout=40mA, 4.0V ≤ Vin ≤ 8.0V		0.15	0.30	%/V
Load stability	$\Delta V_{out} / \Delta I_{out}$	1mA ≤ Iout ≤ 100mA, Vin=4.0V		5	15	mV
Input/output voltage differential	Vdif	Iout=40mA		170	280	mV
Current consumption	I _{ss}	Vin=4.0V		25	45	μA
Stand-by current consumption	I _{standby}	Vin=4.0V, Vce=Vss		0.1	0.5	μA
Input voltage	Vin				8	V
CE Input voltage High	Vceh	Vin=8.0V	1.80		Vin	V
CE Input voltage Low	Vcel	Vin=2.0V	0.00		0.25	V
CE Input current High	Iceh	Vce=Vin		0.4	1.5	μA
CE Input current Low	Icel	Vce=Vss	-0.2	0.0		
Output voltage temperature coefficient	$\Delta V_{out} / \Delta T_{op}$	-40°C ≤ Top ≤ +85°C, Vin=4.0V, Iout=40mA		±100		ppm/°C
Short circuit current	I _{lim}	Vout=0V		70		mA

ELM99xxxxxxBW CMOS Middle current dual voltage regulator

Vout=3.3V, CE="H" active

Top=25°C

Parameter	Symbol	Condition	Min.	Typ.	Max.	Unit
Output voltage	Vout	Vin=4.3V, Iout=40mA	3.234	3.300	3.366	V
Output current	Iout	Vin=4.3V, Lower by 0.1V than Vout	170	300		mA
Input stability	$\Delta V_{out} / \Delta V_{in}$	Iout=40mA, 4.3V \leq Vin \leq 8.0V		0.15	0.30	%/V
Load stability	$\Delta V_{out} / \Delta I_{out}$	1mA \leq Iout \leq 100mA, Vin=4.3V		5	15	mV
Input/output voltage differential	Vdif	Iout=40mA		150	265	mV
Current consumption	I _{ss}	Vin=4.3V		25	45	μ A
Stand-by current consumption	I _{standby}	Vin=4.3V, Vce=V _{ss}		0.1	0.5	μ A
Input voltage	Vin				8	V
CE Input voltage High	Vceh	Vin=8.0V	1.80		Vin	V
CE Input voltage Low	Vcel	Vin=2.0V	0.00		0.25	V
CE Input current High	Iceh	Vce=Vin		0.4	1.5	μ A
CE Input current Low	Icel	Vce=V _{ss}	-0.2	0.0		
Output voltage temperature coefficient	$\Delta V_{out} / \Delta T_{op}$	-40°C \leq Top \leq +85°C, Vin=4.3V, Iout=40mA		\pm 100		ppm/°C
Short circuit current	I _{lim}	Vout=0V		70		mA

Vout=5.0V, CE="H" active

Top=25°C

Parameter	Symbol	Condition	Min.	Typ.	Max.	Unit
Output voltage	Vout	Vin=6.0V, Iout=40mA	4.900	5.000	5.100	V
Output current	Iout	Vin=6.0V, Lower by 0.1V than Vout	200	330		mA
Input stability	$\Delta V_{out} / \Delta V_{in}$	Iout=40mA, 6.0V \leq Vin \leq 8.0V		0.15	0.30	%/V
Load stability	$\Delta V_{out} / \Delta I_{out}$	1mA \leq Iout \leq 100mA, Vin=6.0V		5	15	mV
Input/output voltage differential	Vdif	Iout=40mA		125	220	mV
Current consumption	I _{ss}	Vin=6.0V		30	55	μ A
Stand-by current consumption	I _{standby}	Vin=6.0V, Vce=V _{ss}		0.1	0.5	μ A
Input voltage	Vin				8	V
CE Input voltage High	Vceh	Vin=8.0V	1.80		Vin	V
CE Input voltage Low	Vcel	Vin=2.0V	0.00		0.25	V
CE Input current High	Iceh	Vce=Vin		0.4	1.5	μ A
CE Input current Low	Icel	Vce=V _{ss}	-0.2	0.0		
Output voltage temperature coefficient	$\Delta V_{out} / \Delta T_{op}$	-40°C \leq Top \leq +85°C, Vin=6.0V, Iout=40mA		\pm 100		ppm/°C
Short circuit current	I _{lim}	Vout=0V		70		mA

■ Marking

TSSOP-8

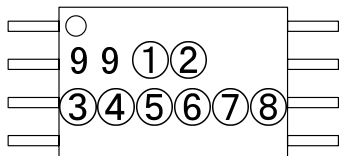

No. ① : Assembly lot No.
A~Z (I, O, X excepted)

No. ② : Assembly lot No.
0~9

No. ③ : the integer digit of output voltage1

Mark	Vout	Mark	Vout
1	1.*V	4	4.*V
2	2.*V	5	5.*V
3	3.*V	6	6.*V

No. ④ : the decimal digit of output voltage1

Mark	Vout	Mark	Vout
0	*.0V	5	*.5V
1	*.1V	6	*.6V
2	*.2V	7	*.7V
3	*.3V	8	*.8V
4	*.4V	9	*.9V

No. ⑤ : Scheme of CE1

1 : No CE1, 2 : CE1="L" active, 3 : CE1="H" active

No. ⑥ : the integer digit of output voltage2

Mark	Vout	Mark	Vout
1	1.*V	4	4.*V
2	2.*V	5	5.*V
3	3.*V	6	6.*V

No. ⑦ : the decimal digit of output voltage2

Mark	Vout	Mark	Vout
0	*.0V	5	*.5V
1	*.1V	6	*.6V
2	*.2V	7	*.7V
3	*.3V	8	*.8V
4	*.4V	9	*.9V

No. ⑧ : Scheme of CE2

1 : No CE2, 2 : CE2="L" active, 3 : CE2="H" active

■ Typical characteristics

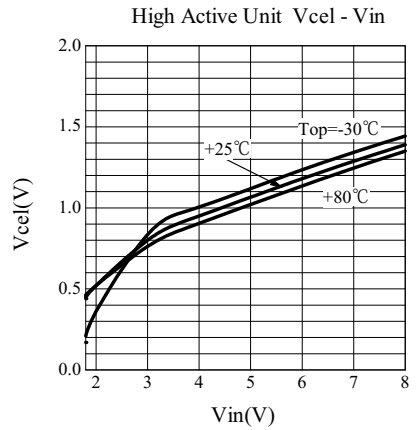
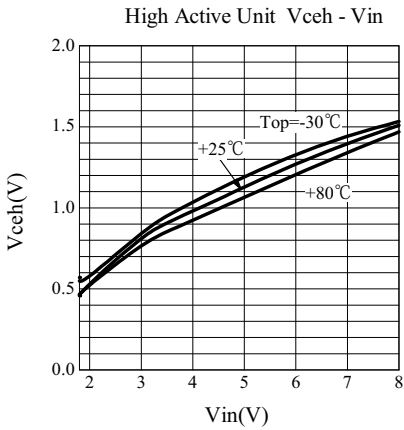
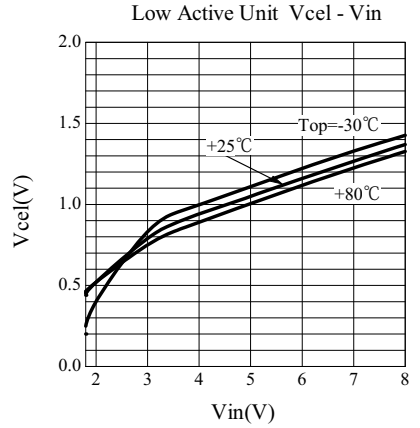
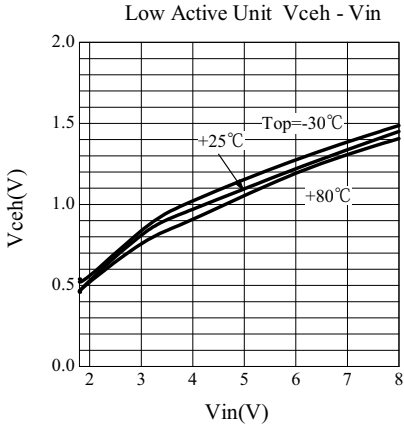

• 2.7V Vout unit

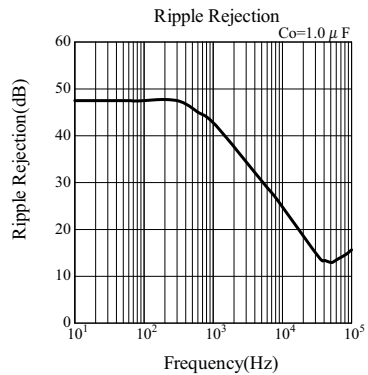
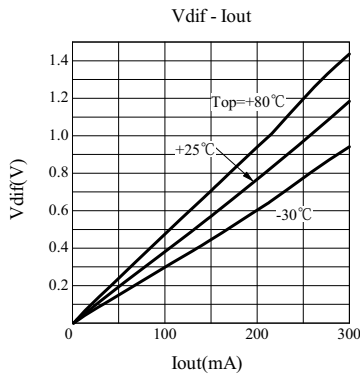
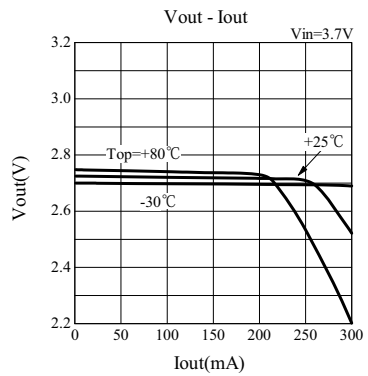
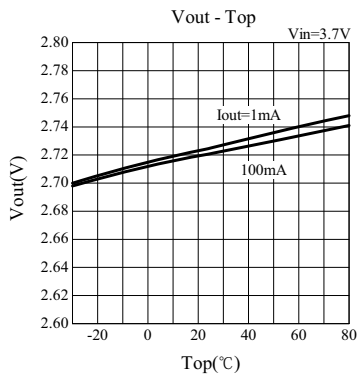
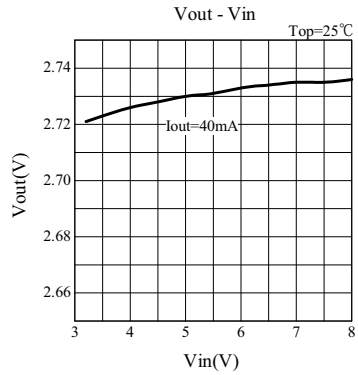
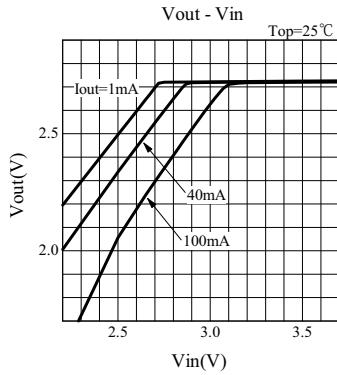

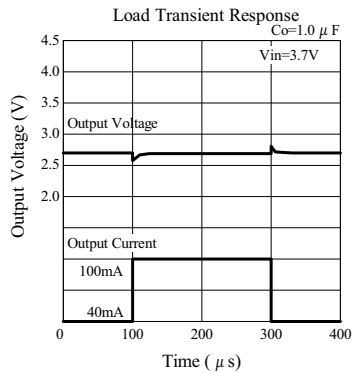
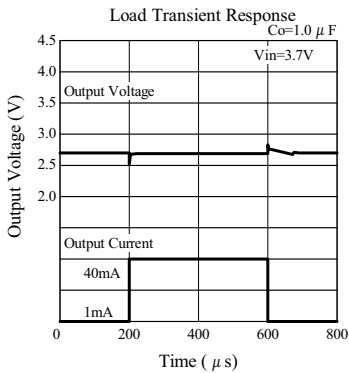
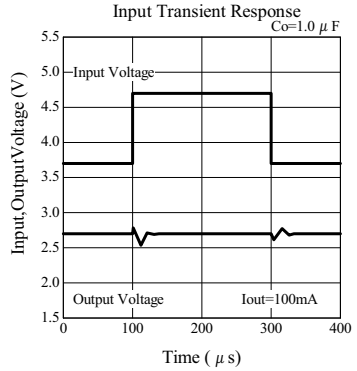
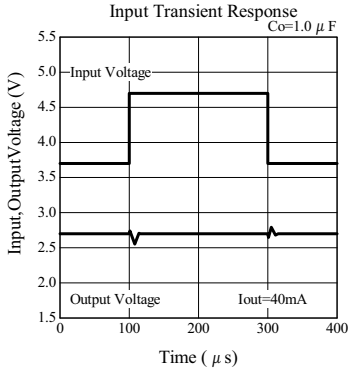
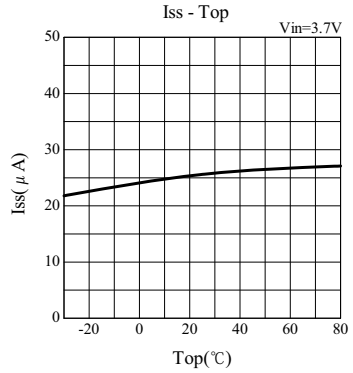
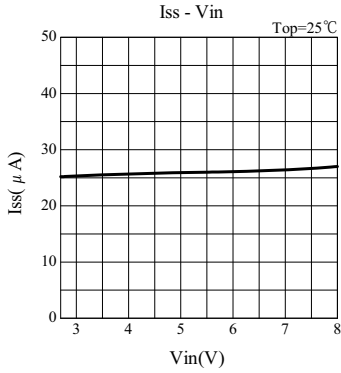

• 3.0V Vout unit

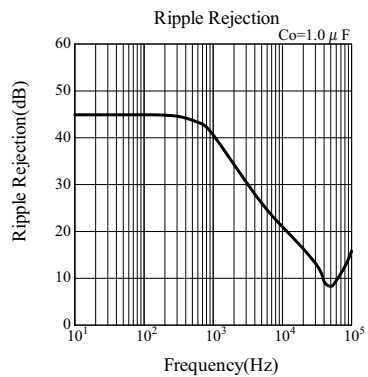
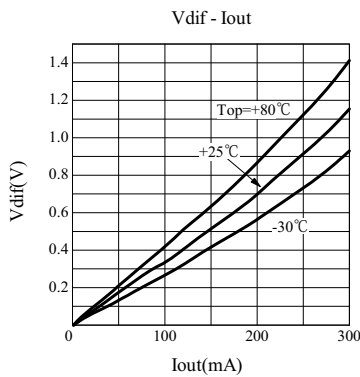
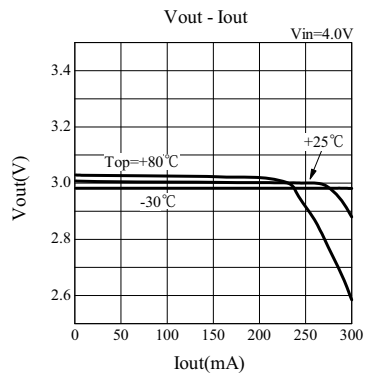
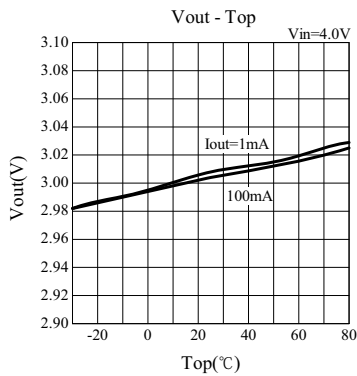
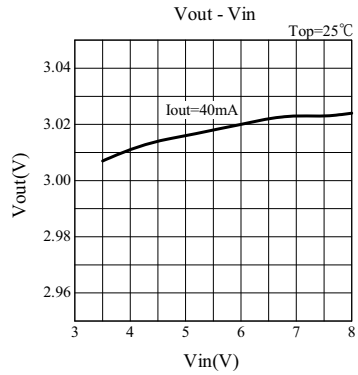
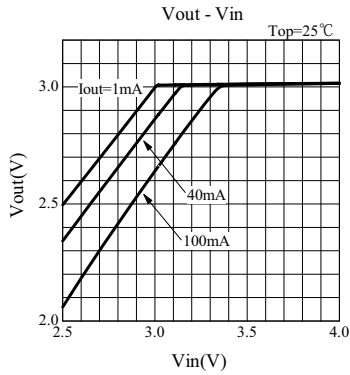

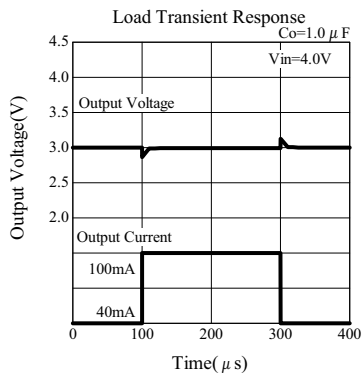
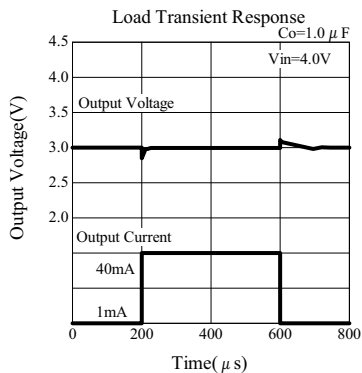
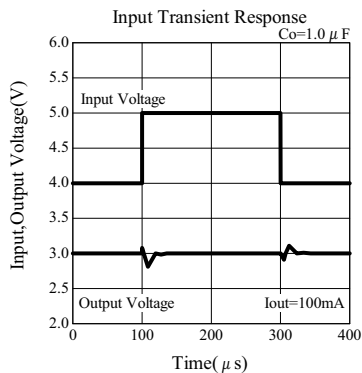
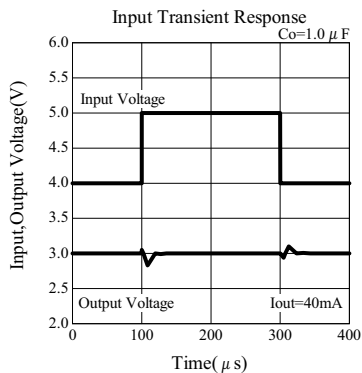
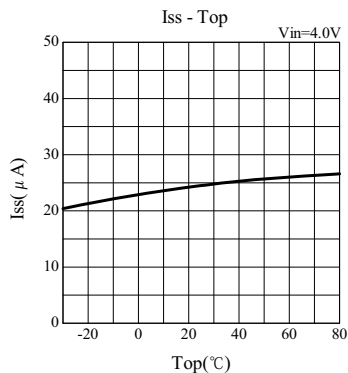
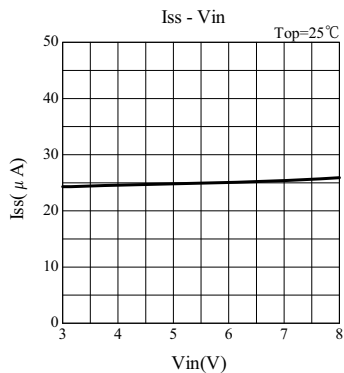

• 3.3V Vout unit

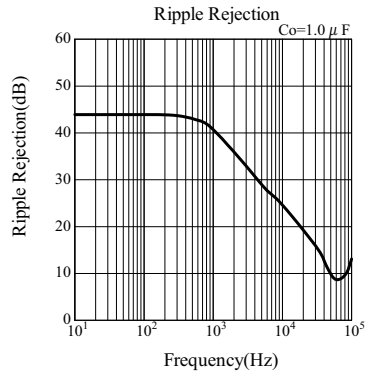
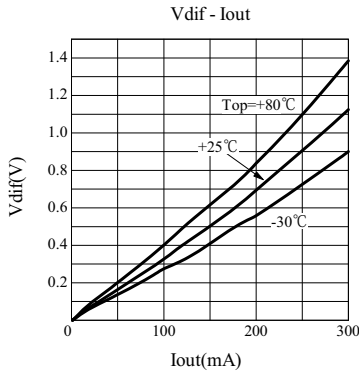
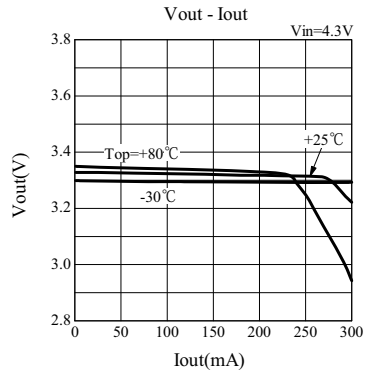
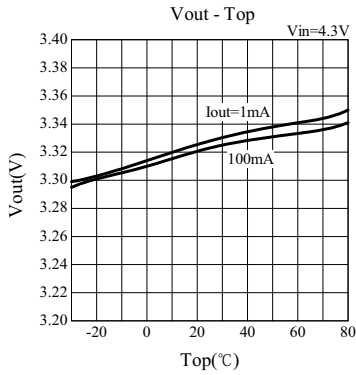
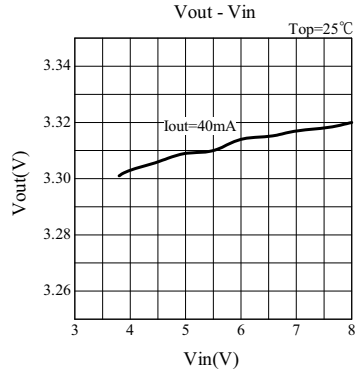
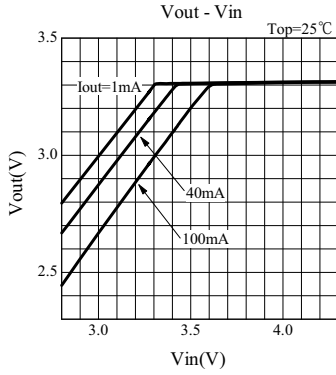

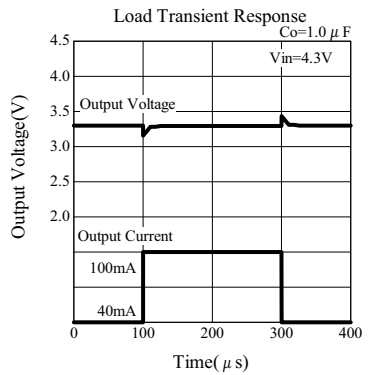
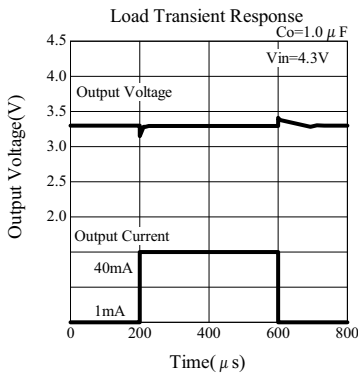
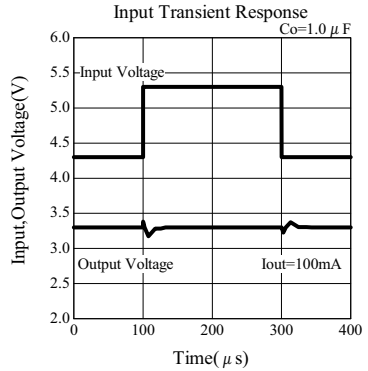
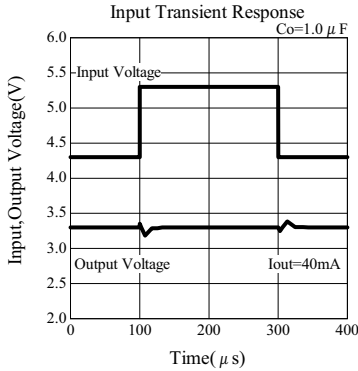
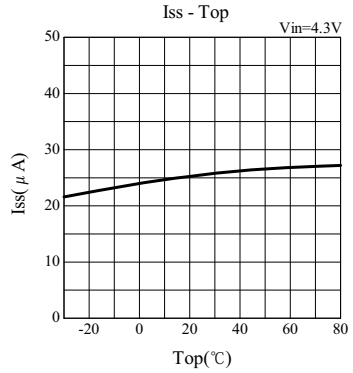
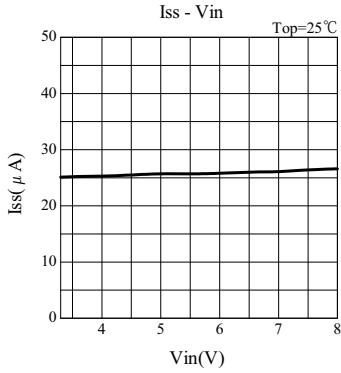

• 5.0V V_{out} unit

