

2SA1677, 2SC4397

2059

T-37-13
T-35-11
PNP/NPN Epitaxial Planar
Silicon Transistors

Switching Applications (with Bias Resistances R1=22kΩ, R2=22kΩ)

©2765

Applications

- Switching circuit, inverter circuit, interface circuit, driver circuit

Features

- On-chip bias resistance (R1=22kohms, R2=22kohms)
- Very small-sized package permitting 2SA1677/2SC4397-applied sets to be made smaller and slimmer

():2SA1677

Absolute Maximum Ratings at Ta=25°C

			unit
Collector to Base Voltage	V _{CB0}	(-)50	V
Collector to Emitter Voltage	V _{CE0}	(-)50	V
Emitter to Base Voltage	V _{EBO}	(-)10	V
Collector Current	I _C	(-)100	mA
Peak Collector Current	i _{cp}	(-)200	mA
Collector Dissipation	P _C	150	mW
Junction Temperature	T _j	150	°C
Storage Temperature	T _{stg}	-55 to +150	°C

Electrical Characteristics at Ta=25°C

			min	typ	max	unit
Collector Cutoff Current	I _{CB0}	V _{CB} =(-)40V, I _B =0			(-)0.1	uA
Collector Cutoff Current	I _{CE0}	V _{CE} =(-)40V, I _B =0			(-)0.5	uA
Emitter Cutoff Current	I _{EBO}	V _{EB} =(-)5V, I _C =0	(-)70	(-)113	(-)150	uA
DC Current Gain	h _{FE}	V _{CE} =(-)5V, I _C =(-)5mA	50			
Gain-Bandwidth Product	f _T	V _{CE} =(-)10V, I _C =(-)5mA		250 (200)		MHz
Output Capacitance	c _{ob}	V _{CB} =(-)10V, f=1MHz		3.3 (5.1)		pF
C-E Saturation Voltage	V _{CE(sat)}	I _C =(-)10mA, I _B =(-)0.5mA	(-)0.1	(-)0.3		V
C-B Breakdown Voltage	V _{(BR)CBO}	I _C =(-)10uA, I _B =0	(-)50			V
C-E Breakdown Voltage	V _{(BR)CEO}	I _C =(-)100uA, R _{BE} =∞	(-)50			V
Input OFF-State Voltage	V _{I(off)}	V _{CE} =(-)5V, I _C =(-)100uA	(-)0.8	(-)1.1	(-)1.5	V
Input ON-State Voltage	V _{I(on)}	V _{CE} =(-)0.2V, I _C =(-)5mA	(-)1.0	(-)1.9	(-)3.0	V
Input Resistance	R _I		15	22	29	kohm
Resistance Ratio	R1/R2		0.9	1.0	1.1	

Marking 2SA1677:CL, 2SC4397:CY

Electrical Connection

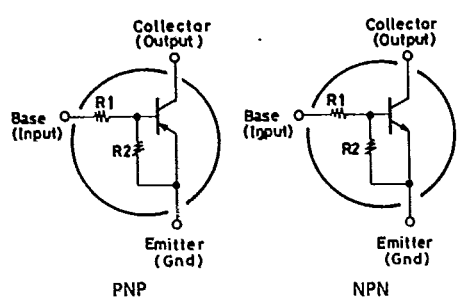

Case Outline 2059 (unit:mm)

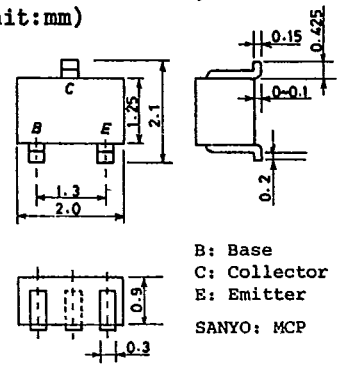

4118YT, TS No.2765-1/2

Sample Application Circuit

Input ON-State voltage: 3V or more

Input OFF-State voltage: 0.8V or less



INPUT

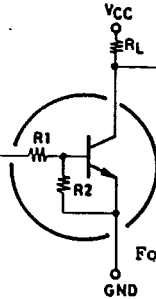

For PNP, the polarity is reversed.

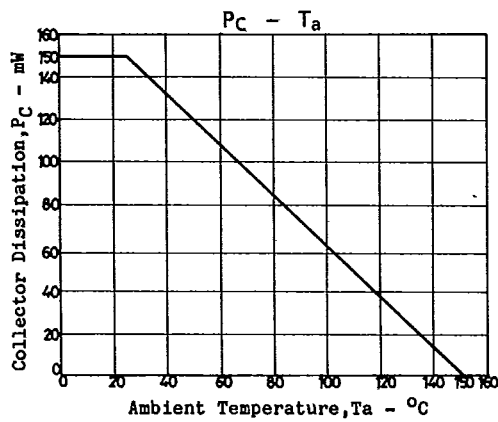
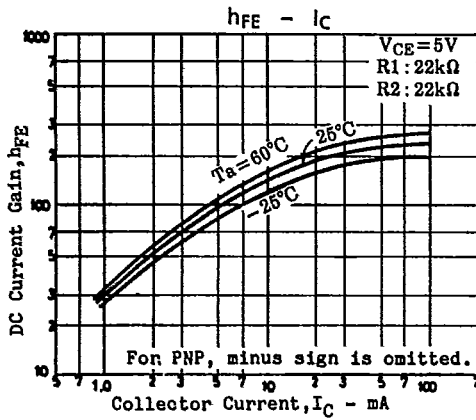
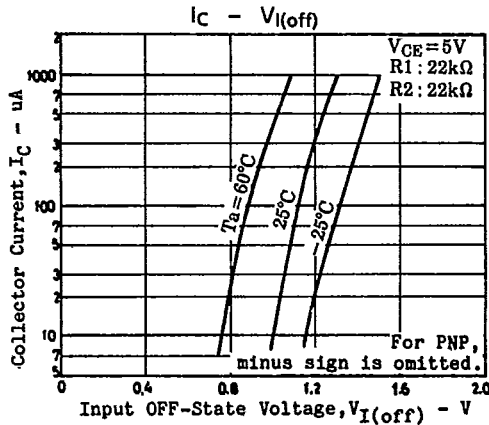
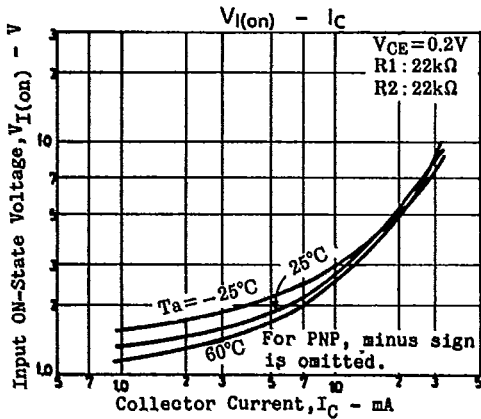

T-91-20

CASE OUTLINES OF SURFACE MOUNT TRANSISTORS

- All of Sanyo surface mount transistor case outlines are illustrated below.
- All dimensions are in mm, and dimensions which are not followed by min. or max. are represented by typical values.
- No marking is indicated.

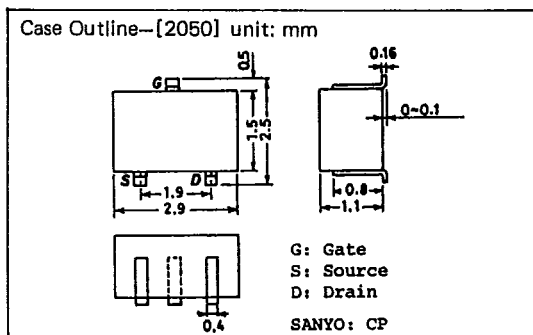
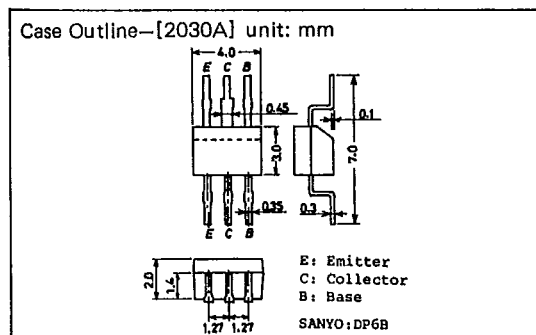
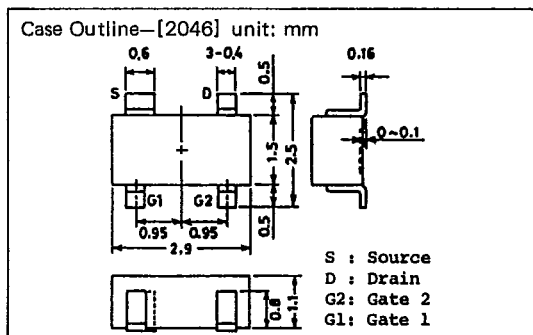
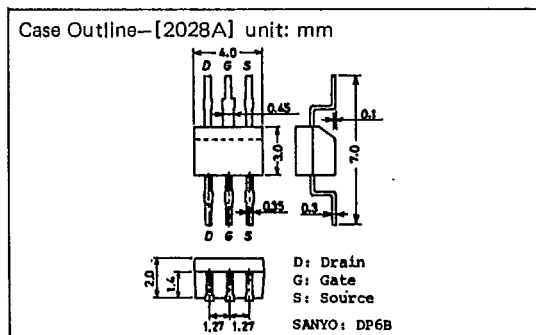
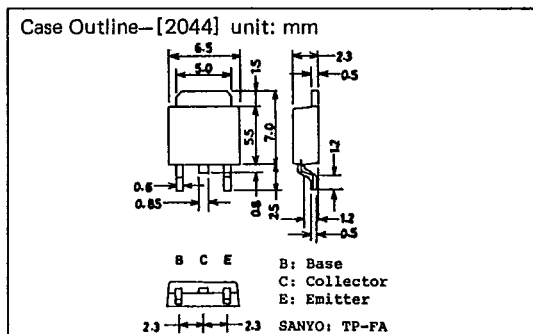
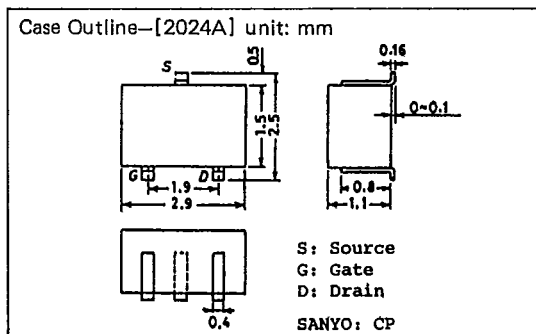
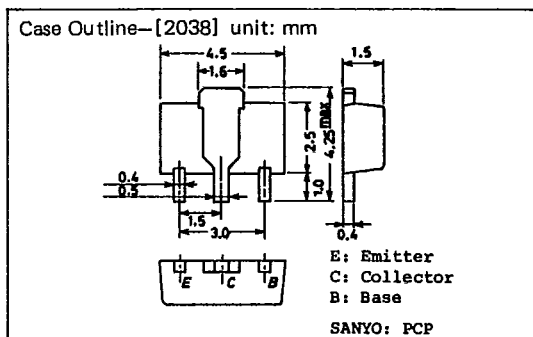
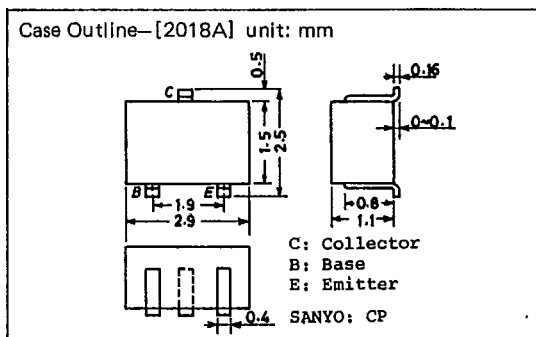

T-91-20

Case Outline—[2057] unit: mm

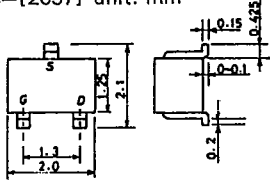

S: Source
G: Gate
D: Drain
SANYO: MCP

Case Outline—[2066] unit: mm

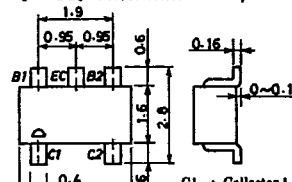

C1 : Collector 1
C2 : Collector 2
B2 : Base 2
EC : Emitter Common
B1 : Base 1
SANYO : CP6

Case Outline—[2058] unit: mm

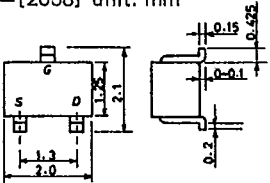

G: Gate
S: Source
D: Drain
SANYO: MCP

Case Outline—[2067] unit: mm

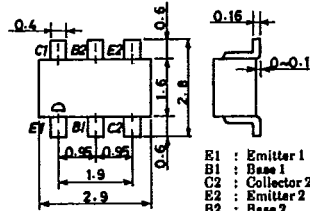

E1 : Emitter 1
B1 : Base 1
C2 : Collector 2
E2 : Emitter 2
B2 : Base 2
C1 : Collector 1
SANYO : CP6

Case Outline—[2059] unit: mm

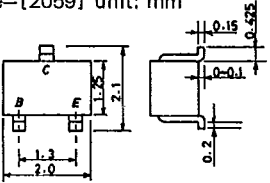

B: Base
C: Collector
E: Emitter
SANYO: MCP

Case Outline—[2068] unit: mm

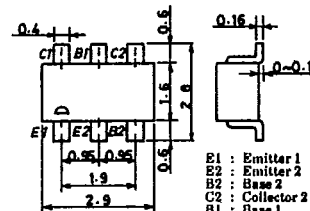

E1 : Emitter 1
E2 : Emitter 2
B2 : Base 2
C2 : Collector 2
B1 : Base 1
C1 : Collector 1
SANYO : CP6

Case Outline—[2062] unit: mm

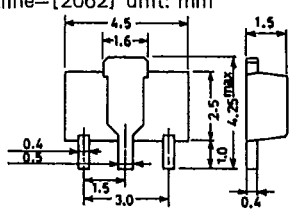

S: Source
D: Drain
G: Gate
SANYO: PCP

Case Outline—[2069] unit: mm

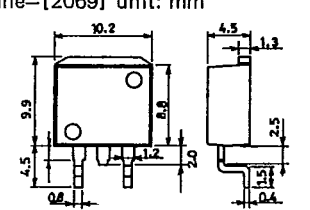

B: Base
C: Collector
E: Emitter
SANYO: SMP

Case Outline—[2065] unit: mm

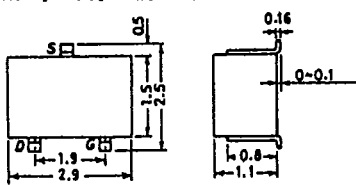

S: Source
D: Drain
G: Gate
SANYO: CP

Case Outline—[2070] unit: mm

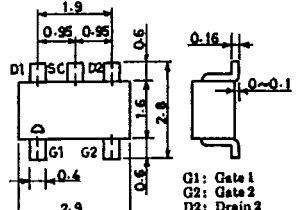

G1 : Gate 1
G2 : Gate 2
D2 : Drain 2
SC : Source Common
D1 : Drain 1
SANYO : CP6

T-9120

