

SANYO	No.2112B	2SB1201/2SD1801
	PNP/NPN Epitaxial Planar Silicon Transistors High-Current Switching Applications	

Applications

- Voltage regulators, relay drivers, lamp drivers, electrical equipment

Features

- Adoption of FBET, MBIT processes
- Large current capacity and wide ASO
- Low collector-to-emitter saturation voltage
- Fast switching speed
- Small and slim package making it easy to make 2SB1201/2SD1801-used sets smaller

() : 2SB1201

Absolute Maximum Ratings at Ta = 25°C

			unit
Collector to Base Voltage	V _{CBO}	(-)	60 V
Collector to Emitter Voltage	V _{CEO}	(-)	50 V
Emitter to Base Voltage	V _{EBO}	(-)	6 V
Collector Current	I _C	(-)	2 A
Collector Current(Pulse)	I _{CP}	(-)	4 A
Collector Dissipation	P _C		0.8 W
		T _c = 25°C	15 W
Junction Temperature	T _j		150 °C
Storage Temperature	T _{stg}		- 55 to + 150 °C

Electrical Characteristics at Ta = 25°C

			min	typ	max	unit
Collector Cutoff Current	I _{CBO}	V _{CB} = (-)50V, I _E = 0			(-)	100 nA
Emitter Cutoff Current	I _{EBO}	V _{EB} = (-)4V, I _C = 0			(-)	100 nA
DC Current Gain	h _{FE} (1)	V _{CE} = (-)2V, I _C = (-)100mA	100*		560*	
	h _{FE} (2)	V _{CE} = (-)2V, I _C = (-)1.5A	40			
Gain-Bandwidth Product	f _T	V _{CE} = (-)10V, I _C = (-)50mA		150		MHz
Output Capacitance	c _{ob}	V _{CE} = (-)10V, f = 1MHz		(22)12		pF
C-E Saturation Voltage	V _{CE(sat)}	I _C = (-)1A, I _B = (-)50mA		0.15	0.4	V
				(-0.3)	(-0.7)	

Continued on next page.

* : The 2SB1201/2SD1801 are classified by 100mA h_{FE} as follows :

100 R 200	140 S 280	200 T 400	280 U 560
-----------	-----------	-----------	-----------

Package Dimensions 2045B

(unit : mm)

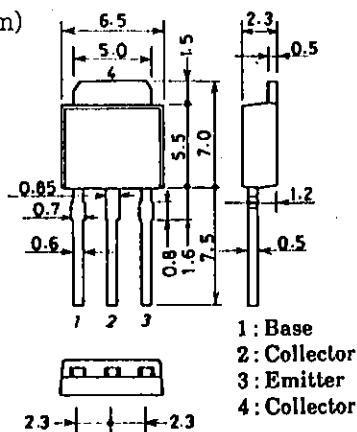

Package Dimensions 2044B

(unit : mm)

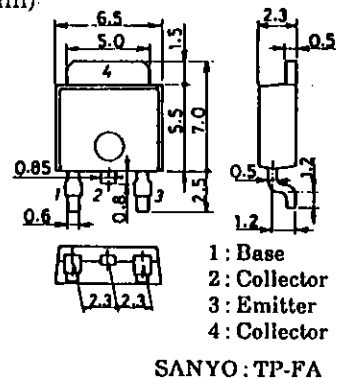

2SB1201/2SD1801

Continued from preceding page.

			min	typ	max	unit
B-E Saturation Voltage	$V_{BE(sat)}$	$I_C = (-)1A, I_B = (-)50mA$		(-)0.9	(-)1.2	V
C-B Breakdown Voltage	$V_{(BR)CBO}$	$I_C = (-)10\mu A, I_E = 0$	(-)60			V
C-E Breakdown Voltage	$V_{(BR)CEO}$	$I_C = (-)1mA, R_{BE} = \infty$	(-)50			V
E-B Breakdown Voltage	$V_{(BR)EBO}$	$I_E = (-)10\mu A, I_C = 0$	(-)6			V
Turn-on Time	t_{on}	See specified Test Circuit.		60		ns
Storage Time	t_{stg}			(450)550		ns
Fall Time	t_f			30		ns

Switching Time Test Circuit

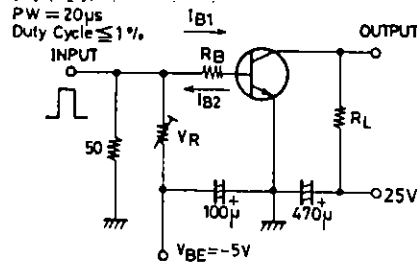

$I_C = 10 I_B = -10 I_{B2} = 500mA, V_{CC} = 25V$
(For PNP, the polarity is reversed.)

Unit (Resistance : Ω , Capacitance : F)

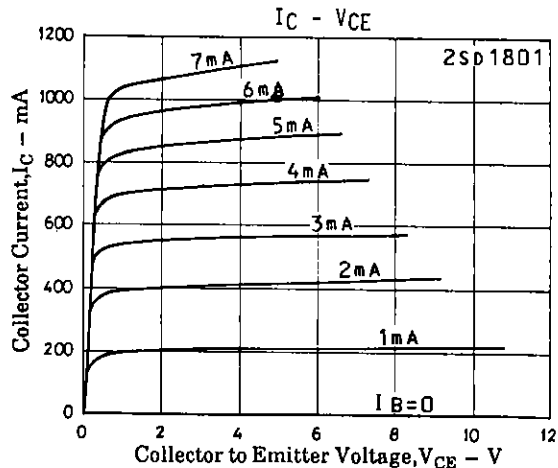
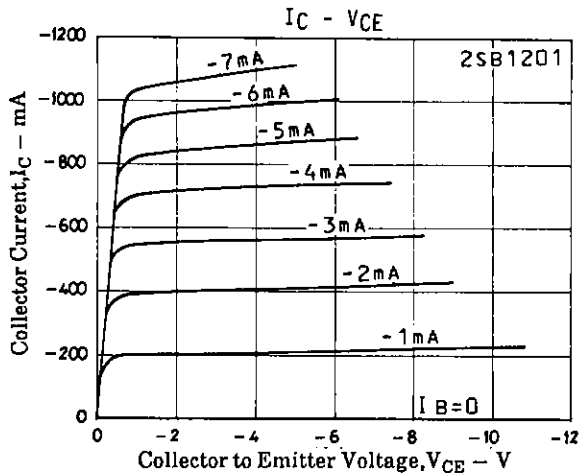
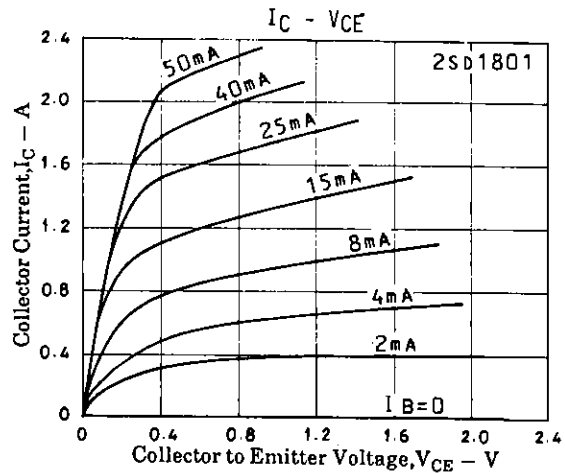
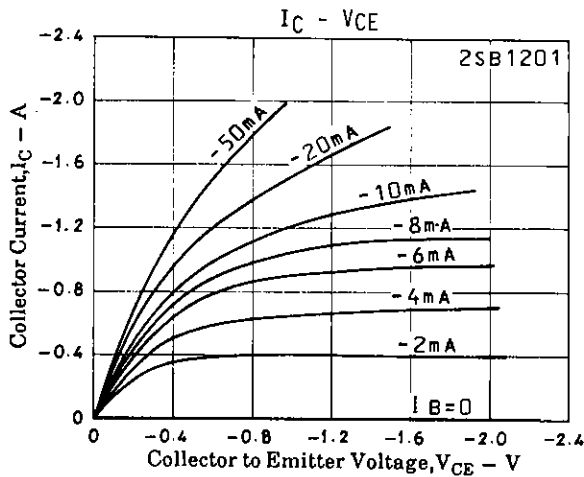

2SB1201/2SD1801

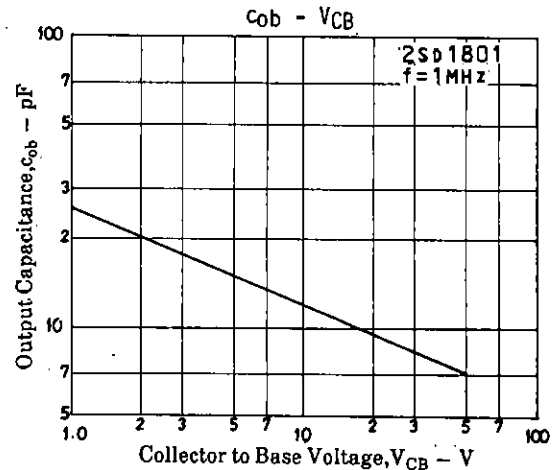
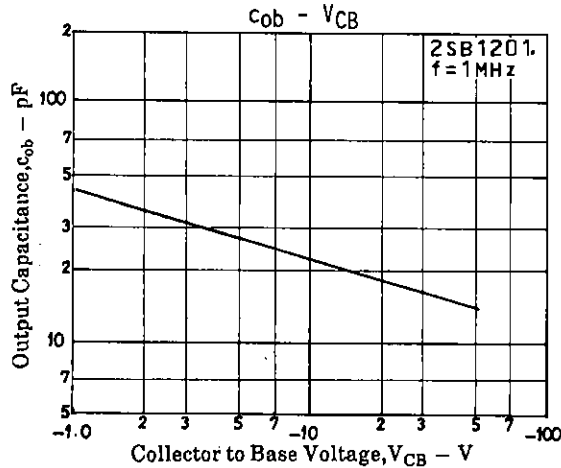
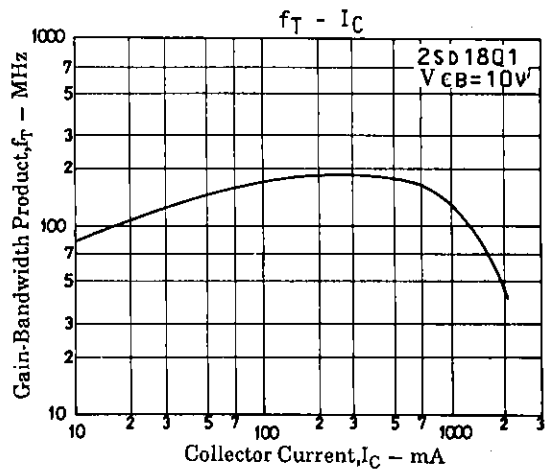
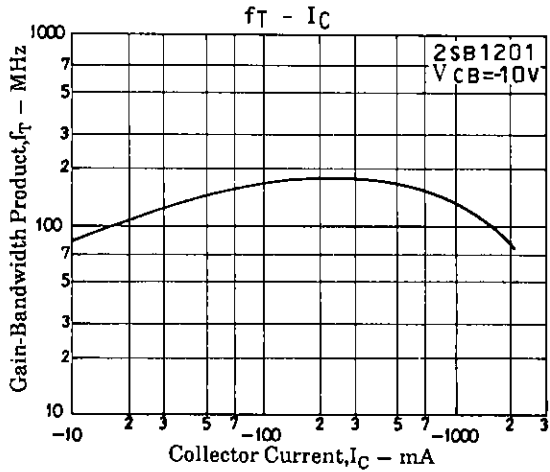
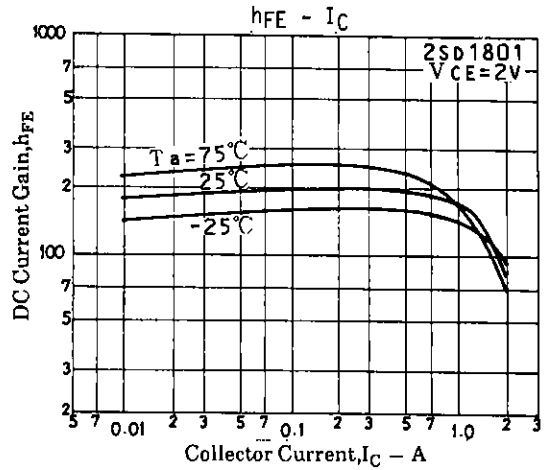
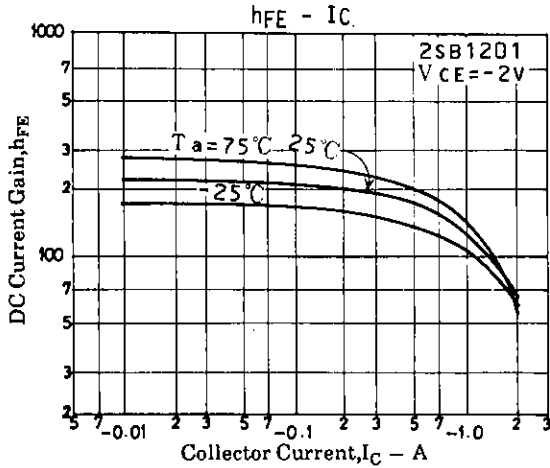
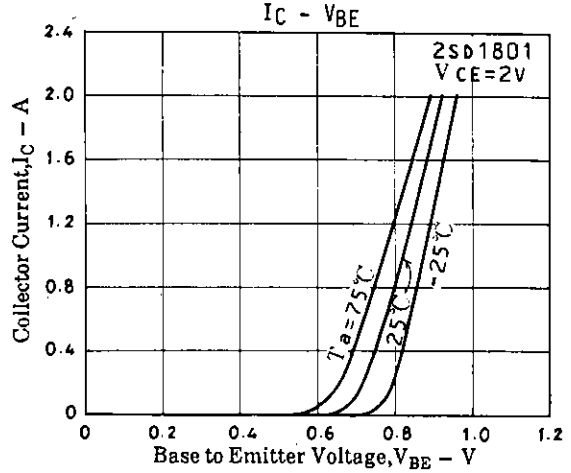
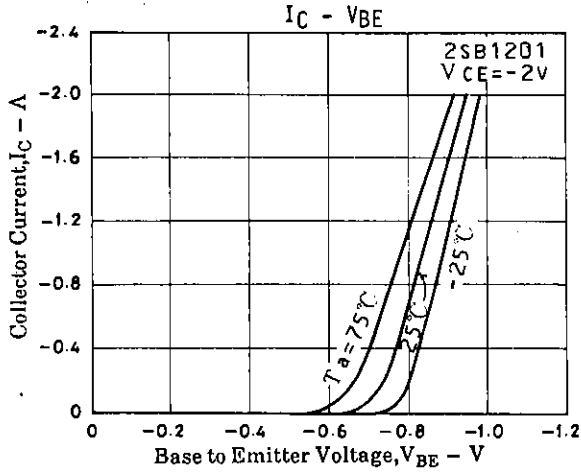

2SB1201/2SD1801

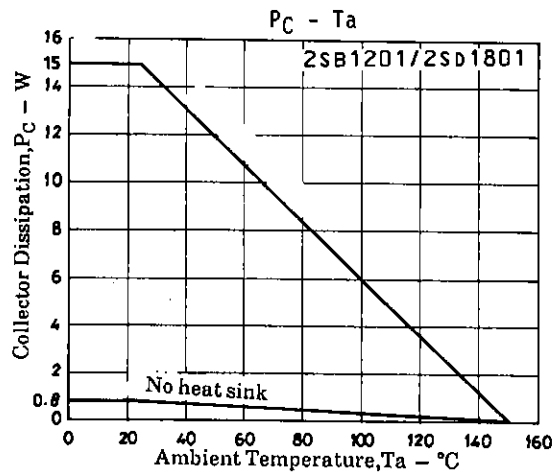
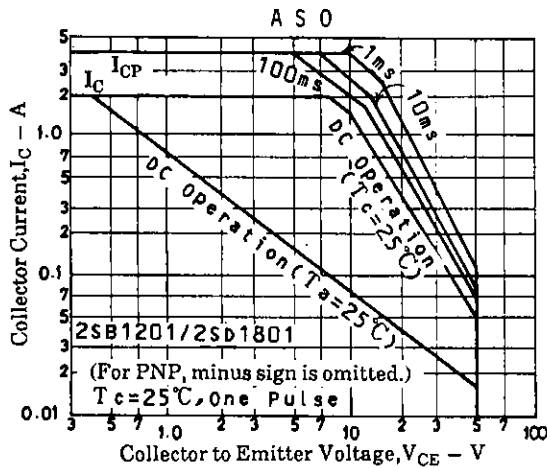
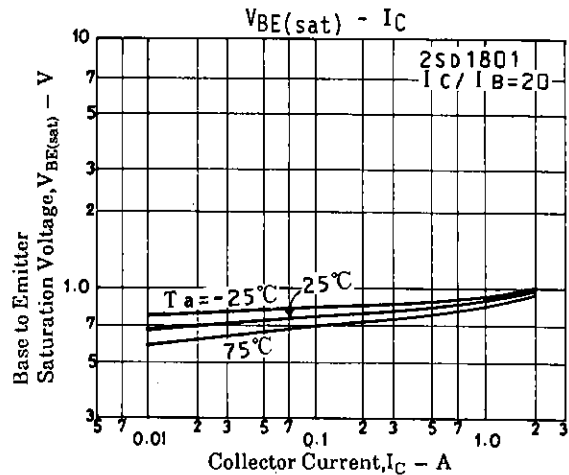
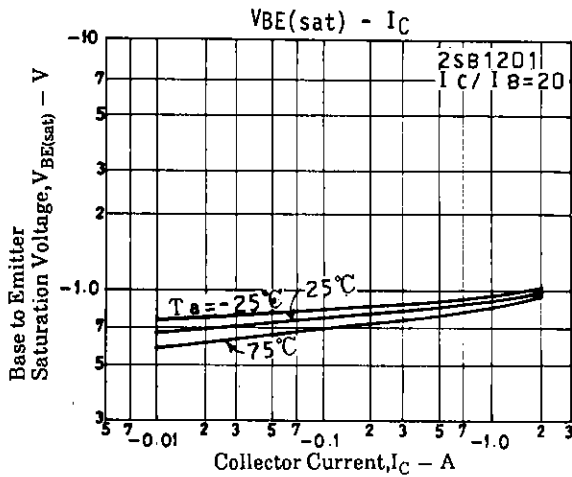
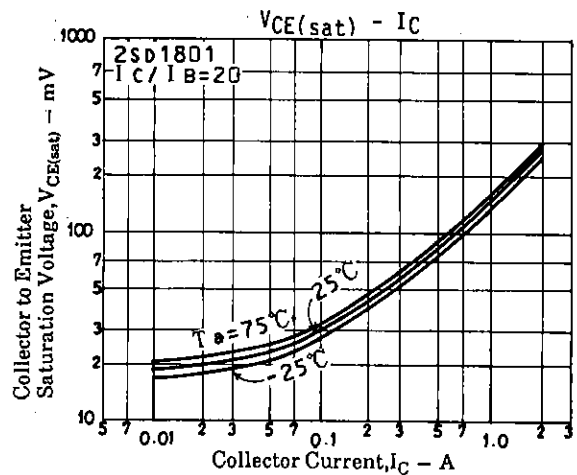
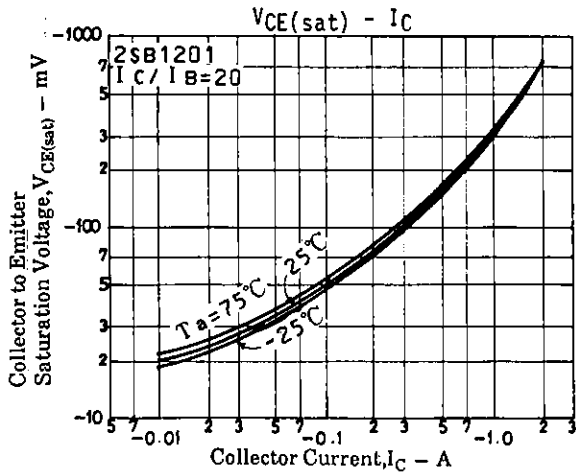

■ No products described or contained herein are intended for use in surgical implants, life-support systems, aerospace equipment, nuclear power control systems, vehicles, disaster/crime-prevention equipment and the like, the failure of which may directly or indirectly cause injury, death or property loss.

■ Anyone purchasing any products described or contained herein for an above-mentioned use shall:

- ① Accept full responsibility and indemnify and defend SANYO ELECTRIC CO., LTD., its affiliates, subsidiaries and distributors and all their officers and employees, jointly and severally, against any and all claims and litigation and all damages, cost and expenses associated with such use;
- ② Not impose any responsibility for any fault or negligence which may be cited in any such claim or litigation on SANYO ELECTRIC CO., LTD., its affiliates, subsidiaries and distributors or any of their officers and employees jointly or severally.

■ Information (including circuit diagrams and circuit parameters) herein is for example only; it is not guaranteed for volume production. SANYO believes information herein is accurate and reliable, but no guarantees are made or implied regarding its use or any infringements of intellectual property rights or other rights of third parties.