

2SA1341, 2SC3395



2018A

T-37-13
T-35-11

PNP/NPN Epitaxial Planar
Silicon Transistors

Switching Applications (with Bias Resistances R1=47kΩ, R2=47kΩ)

©1283C

Applications

- Switching circuit, inverter circuit, interface circuit, driver circuit.

Features

- Built-in bias resistor (R1=47kΩ, R2=47kΩ).
- Small-sized package (CP).

() : 2SA1341

Absolute Maximum Ratings/Ta=25°C

			unit
Collector to Base Voltage	VCBO	(-)50	V
Collector to Emitter Voltage	VCEO	(-)50	V
Emitter to Base Voltage	VEBO	(-)10	V
Collector Current	IC	(-)100	mA
Peak Collector Current	icp	(-)200	mA
Collector Dissipation	PC	200	mW
Junction Temperature	Tj	150	°C
Storage Temperature	Tstg	-55 to +150	°C

Electrical Characteristics/Ta=25°C

			min	typ	max	unit
Collector Cutoff Current	ICBO	VCB=(-)40V, IE=0			(-)0.1	μA
Collector Cutoff Current	ICEO	VCE=(-)40V, IB=0			(-)0.5	μA
Emitter Cutoff Current	IEBO	VEB=(-)5V, IC=0	(-)30	(-)53	(-)80	μA
DC Current Gain	hFE	VCE=(-)5V, IC=(-)5mA	50			
Gain Band-width product	fT	VCE(-)10V, IC(-)5mA		250 (200)		MHz
Output Capacitance	cob	VCB=(-)10V, f=1MHz		3.5 (5.3)		pF
Collector to Emitter Saturation Voltage	VCE(sat)	IC=(-)5mA, IB=(-)0.25mA	(-)0.1	(-)0.3		V

Continued on next page.

Marking

2SA1341:BL, 2SC3395:BY

Electrical Connection

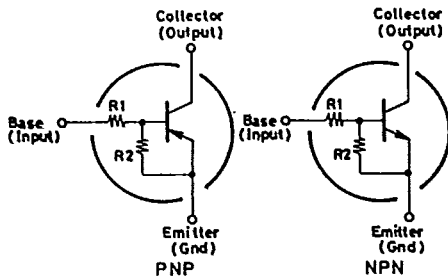

Case Outline 2018A (unit : mm)

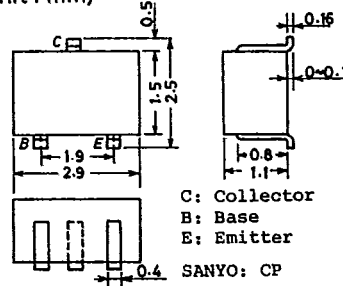

2SA1341/2SC3395

T-37-13

T-35-11

Continued from preceding page.

			min	typ	max	unit
Collector to Base Breakdown Voltage	$V_{(BR)CBO}$	$I_C=(-)10\mu A, I_E=0$	(-)50			V
Collector to Emitter Breakdown Voltage	$V_{(BR)CEO}$	$I_C=(-)100\mu A, R_{BE}=\infty$	(-)50			V
Input Off Voltage	$V_{I(off)}$	$V_{CE}=(-)5V, I_C=(-)100\mu A$	(-)0.8	(-)1.1	(-)1.5	V
Input On Voltage	$V_{I(on)}$	$V_{CE}=(-)0.2V, I_C=(-)5mA$	(-)1.0	(-)2.5	(-)5.0	V
Input Resistance	R_1		32	47	62	k Ω
Input Resistance Ratio	R_1/R_2		0.9	1.0	1.1	-

■ Sample Application Circuit

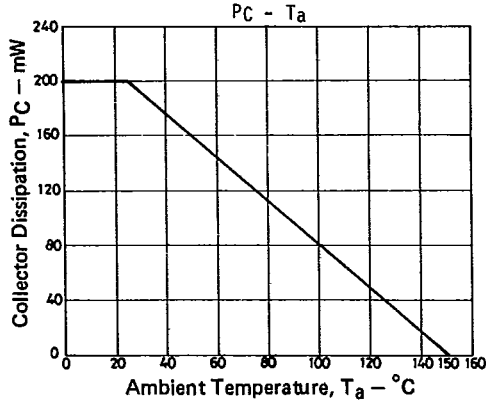
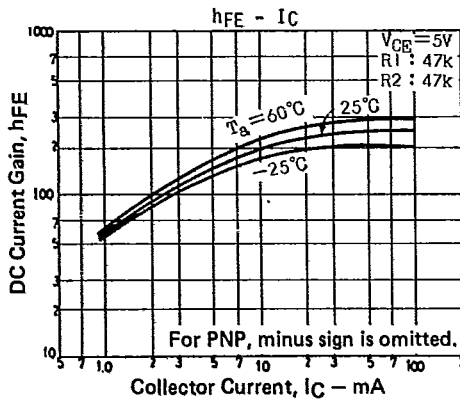
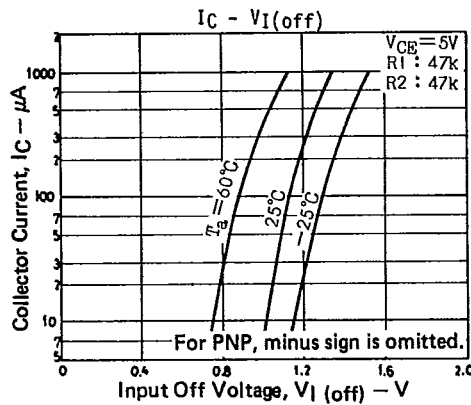
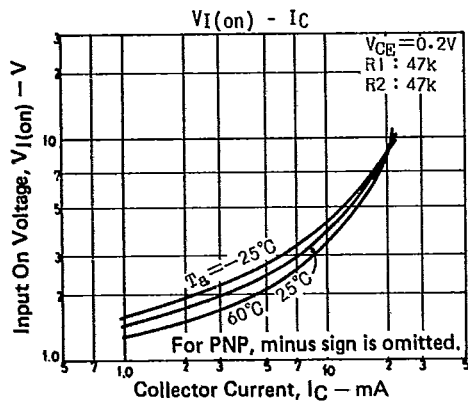
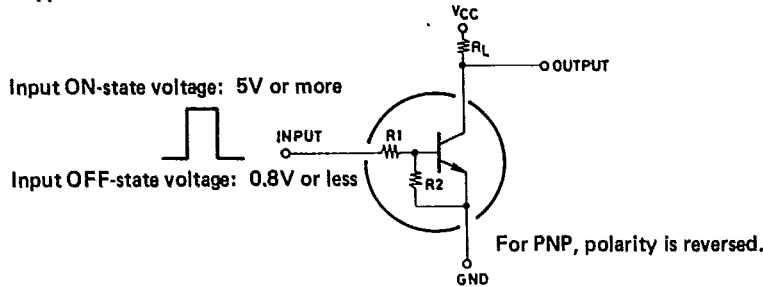

T-91-20

CASE OUTLINES OF SURFACE MOUNT TRANSISTORS

- All of Sanyo surface mount transistor case outlines are illustrated below.
- All dimensions are in mm, and dimensions which are not followed by min. or max. are represented by typical values.
- No marking is indicated.

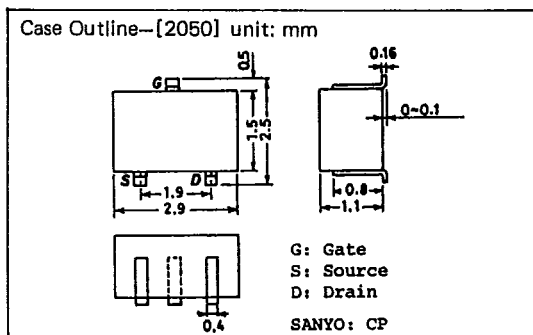
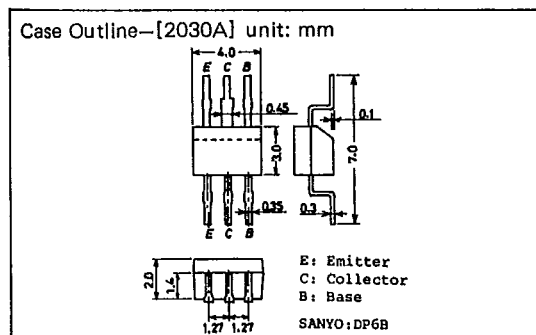
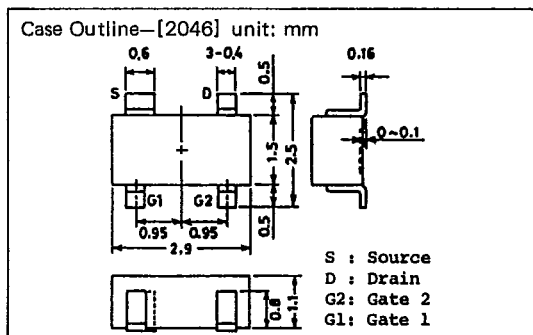
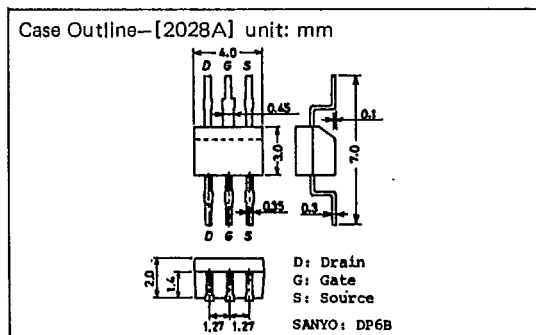
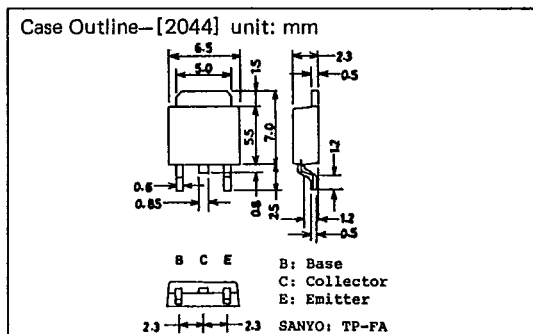
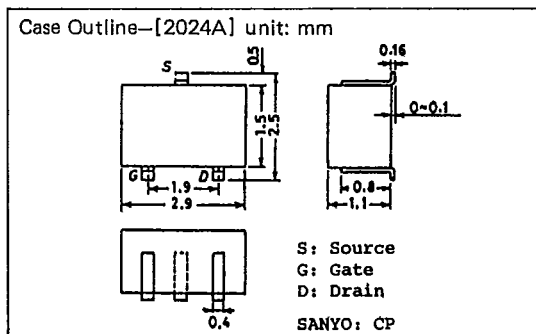
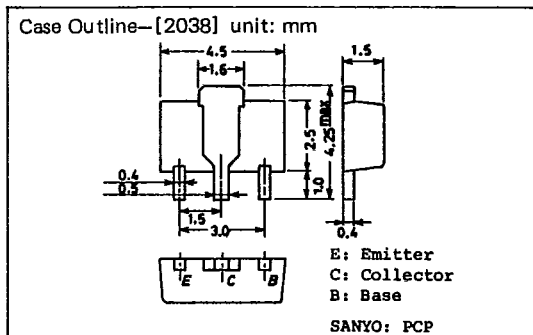
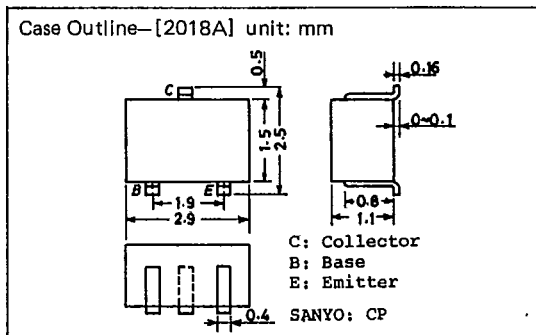

T-91-20

Case Outline—[2057] unit: mm

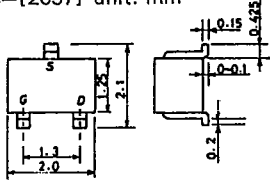

S: Source
G: Gate
D: Drain
SANYO: MCP

Case Outline—[2066] unit: mm

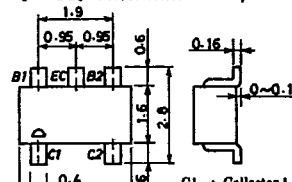

C1 : Collector 1
C2 : Collector 2
B2 : Base 2
EC : Emitter Common
B1 : Base 1
SANYO : CP6

Case Outline—[2058] unit: mm

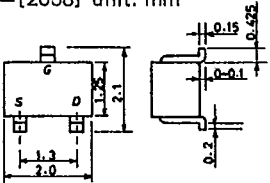

G: Gate
S: Source
D: Drain
SANYO: MCP

Case Outline—[2067] unit: mm

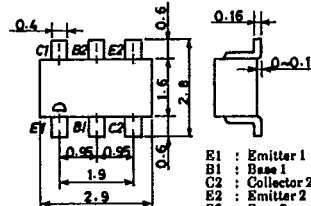

E1 : Emitter 1
B1 : Base 1
C2 : Collector 2
E2 : Emitter 2
B2 : Base 2
C1 : Collector 1
SANYO : CP6

Case Outline—[2059] unit: mm

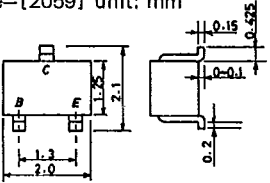

B: Base
C: Collector
E: Emitter
SANYO: MCP

Case Outline—[2068] unit: mm

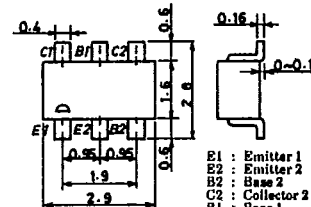

B1 : Emitter 1
E2 : Emitter 2
B2 : Base 2
C2 : Collector 2
B1 : Base 1
C1 : Collector 1
SANYO : CP6

Case Outline—[2062] unit: mm

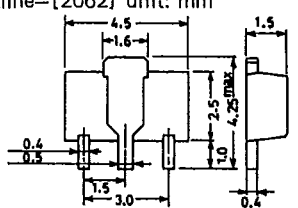

S: Source
D: Drain
G: Gate
SANYO: PCP

Case Outline—[2069] unit: mm

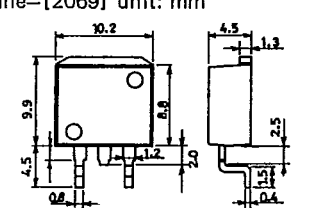

B: Base
C: Collector
E: Emitter
SANYO: SMP

Case Outline—[2065] unit: mm

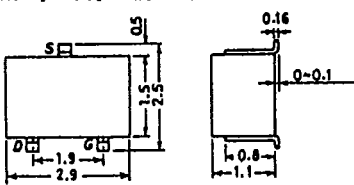

S: Source
D: Drain
G: Gate
SANYO: CP

Case Outline—[2070] unit: mm

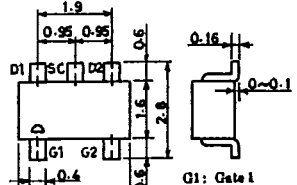

G1 : Gate 1
G2 : Gate 2
D2 : Drain 2
SC : Source Common
D1 : Drain 1
SANYO : CP6

T-9120

