

# Transistor 2SC5547

For High Frequency Amplify Application  
Silicon NPN Epitaxial Type

## DESCRIPTION

2SC5547 is SC-62(SOT-89) package resin sealed silicon NPN epitaxial transistor. It is designed for high frequency application.

## FEATURE

- High gain bandwidth product.  $f_T=4.5\text{GHz}$
- High gain, low noise
- Can operate at low voltage.
- SC-62(SOT-89) package easy mounting

## APPLICATION

For TV tuners, high frequency amplifier, cellular phone system.

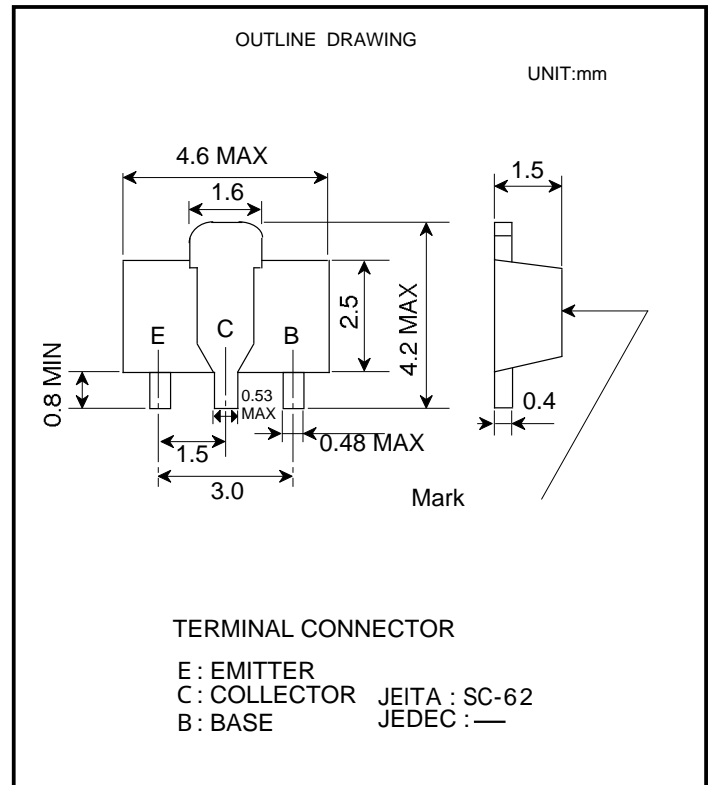

## MAXIMUM RATINGS (Ta=25 °C)

Symbol	Parameter	Ratings	unit
V <sub>CB0</sub>	Collector to Base voltage	20	V
V <sub>EB0</sub>	Emitter to Base voltage	3	V
V <sub>CEO</sub>	Collector to Emitter voltage	15	V
I <sub>C</sub>	Collector current	50	mA
P <sub>C</sub>	Collector dissipation	400	mW
T <sub>j</sub>	Junction temperature	+150	
T <sub>stg</sub>	Storage temperature	-55 ~ +150	

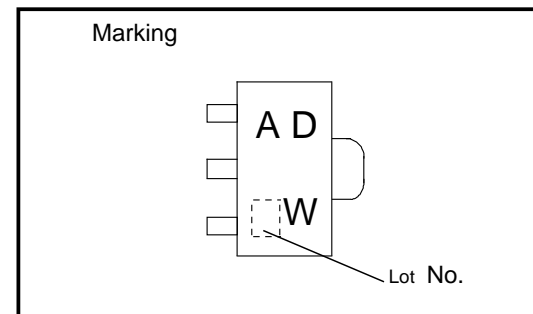

## ELECTRICAL CHARACTERISTICS (Ta=25 °C)

Symbol	Parameter	Test conditions	Limits			unit
			min	typ	max	
V <sub>(BR)CBO</sub>	C to B break down voltage	I <sub>CB</sub> =10 μA, I <sub>E</sub> =0	20			V
V <sub>(BR)CEO</sub>	C to E break down voltage	I <sub>C</sub> =1mA, R <sub>BE</sub> =	15			V
I <sub>CBO</sub>	Collector cut off current	V <sub>CB</sub> =15V, I <sub>E</sub> =0			0.5	μA
I <sub>EBO</sub>	Emitter cut off current	V <sub>EB</sub> =3V, I <sub>C</sub> =0			10	μA
h <sub>FE</sub>	DC forward current gain	V <sub>CE</sub> =5V, I <sub>C</sub> =20mA	30	90	200	—
C <sub>ob</sub>	Collector output capacitance	V <sub>CB</sub> =5V, I <sub>E</sub> =0, f=1MHz		1.0	1.5	pF
f <sub>T</sub>	Gain bandwidth product	V <sub>CE</sub> =5V, I <sub>E</sub> =-20mA	3.5	4.5		GHz
S <sub>21</sub>   <sup>2</sup>	Insertion power gain	V <sub>CB</sub> =5V, I <sub>C</sub> =20mA, f=1.8GHz		9.0		dB
NF	Noise figure	V <sub>CE</sub> =5V, I <sub>C</sub> =5mA, f=1.0GHz		1.5		dB

Transistor  
**2SC5547**

For High Frequency Amplify Application  
Silicon NPN Epitaxial Type

DC forward current gain  
VS. Collector current

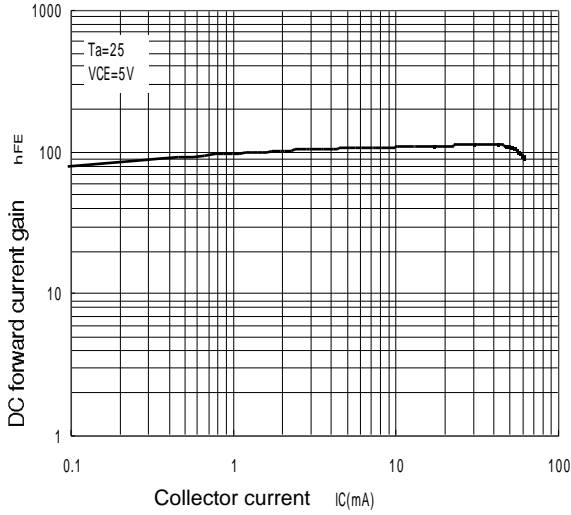

Common Emitter Transfer

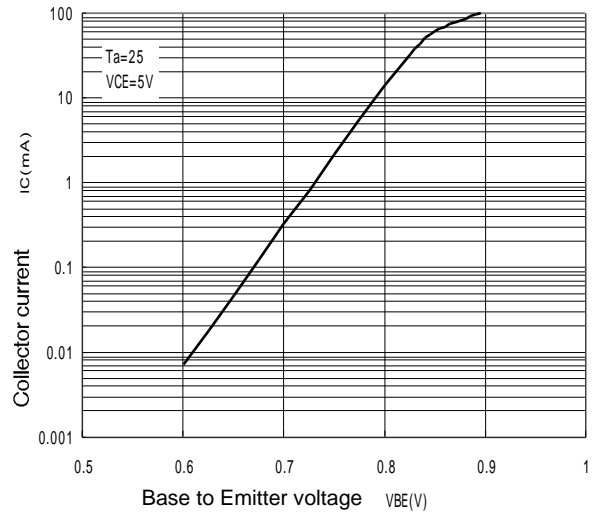

Gain bandwidth product  
VS. Collector current

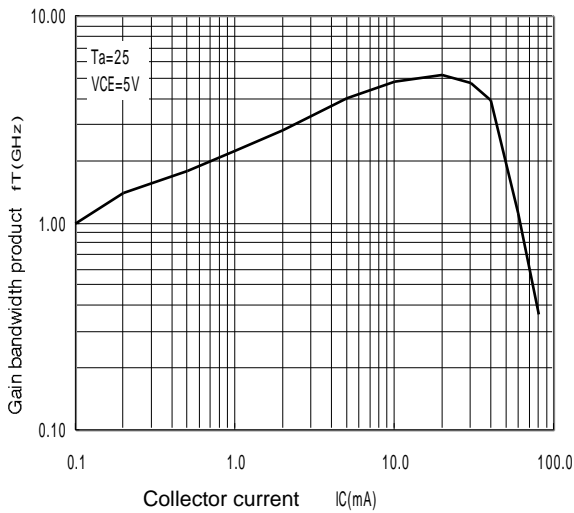

Insertion power gain  
VS. Collector current

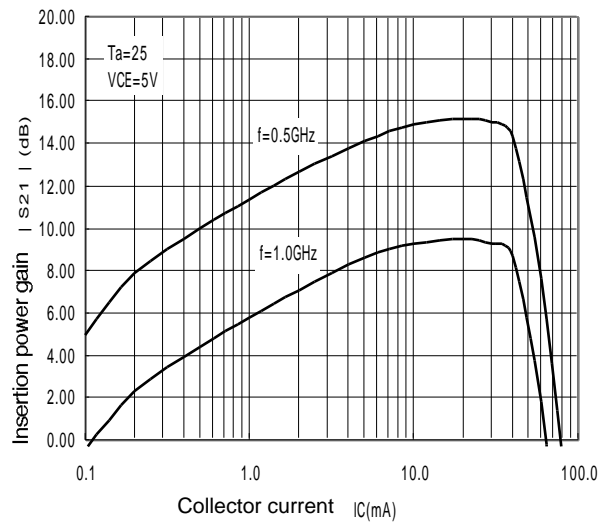

Collector output capacitance  
VS. Collector to Base voltage

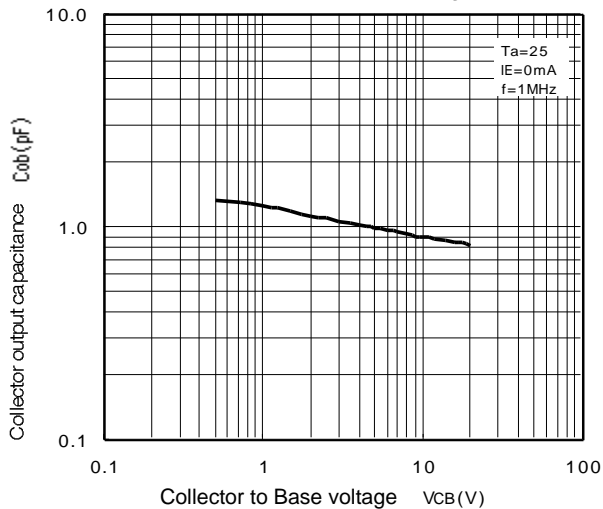

Noise Figure VS. Collector current

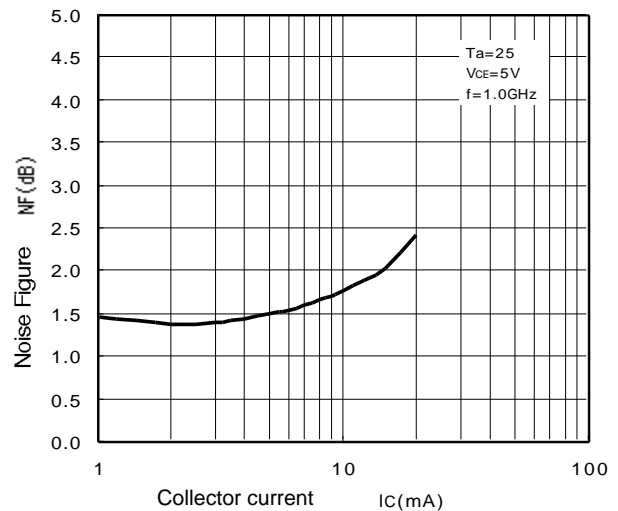

## S parameter

VCE=5V,IC=5mA

FREQUENCY (MHZ)	S11		S21		S12		S22	
	MAG	ANG	MAG	ANG	MAG	ANG	MAG	ANG
500.00	0.334	-143.8	0.098	50.7	5.077	86.1	0.433	-56.6
600.00	0.321	-154.7	0.108	51.8	4.301	80.3	0.409	-59.8
700.00	0.312	-164.0	0.119	52.4	3.721	75.2	0.400	-62.7
800.00	0.305	-172.2	0.130	52.9	3.281	70.4	0.397	-65.6
900.00	0.301	-179.5	0.141	52.9	2.948	65.7	0.405	-68.4
1000.00	0.293	173.3	0.153	52.8	2.675	61.3	0.409	-71.1
1100.00	0.285	166.3	0.165	53.0	2.441	57.3	0.413	-73.7
1200.00	0.281	160.5	0.177	52.6	2.258	53.4	0.424	-76.0
1300.00	0.277	154.1	0.189	52.0	2.099	49.6	0.432	-78.5
1400.00	0.273	147.5	0.200	51.4	1.957	46.1	0.443	-80.6
1500.00	0.271	141.7	0.213	50.9	1.843	42.6	0.454	-83.2
1600.00	0.270	135.7	0.227	49.9	1.741	39.2	0.462	-85.5
1700.00	0.268	129.5	0.238	49.0	1.650	35.9	0.473	-87.3
1800.00	0.268	123.1	0.250	48.1	1.572	32.9	0.484	-89.5
1900.00	0.269	118.1	0.264	47.1	1.502	29.8	0.495	-91.8
2000.00	0.270	112.8	0.276	45.9	1.434	26.9	0.507	-93.9

VCE=5V,IC=2mA

FREQUENCY (MHZ)	S11		S21		S12		S22	
	MAG	ANG	MAG	ANG	MAG	ANG	MAG	ANG
500.00	0.410	-117.8	0.131	38.9	4.272	91.5	0.639	-50.9
600.00	0.399	-128.3	0.134	36.7	3.612	85.5	0.599	-55.9
700.00	0.389	-138.5	0.139	35.3	3.142	79.9	0.577	-60.0
800.00	0.382	-147.4	0.142	34.7	2.749	74.9	0.559	-63.7
900.00	0.377	-156.1	0.144	34.6	2.471	69.7	0.554	-67.2
1000.00	0.366	-163.9	0.148	35.8	2.240	64.6	0.547	-70.3
1100.00	0.359	-170.1	0.152	36.9	2.034	59.9	0.546	-73.2
1200.00	0.356	-176.7	0.156	38.4	1.864	55.5	0.551	-75.9
1300.00	0.354	176.6	0.162	39.8	1.730	51.4	0.554	-78.2
1400.00	0.350	169.9	0.168	41.2	1.610	47.6	0.561	-81.1
1500.00	0.349	163.5	0.176	42.6	1.515	43.8	0.567	-83.6
1600.00	0.346	156.4	0.185	43.9	1.425	40.0	0.573	-86.1
1700.00	0.343	149.7	0.194	44.9	1.347	36.5	0.582	-88.2
1800.00	0.343	143.8	0.205	45.4	1.282	33.0	0.589	-90.4
1900.00	0.343	137.2	0.216	46.0	1.226	29.8	0.597	-92.7
2000.00	0.350	132.4	0.228	46.4	1.153	26.5	0.609	-95.2

VCE=5V,IC=10mA

FREQUENCY (MHZ)	S11		S21		S12		S22	
	MAG	ANG	MAG	ANG	MAG	ANG	MAG	ANG
500.00	0.300	-164.4	0.089	62.0	5.555	81.9	0.326	-55.8
600.00	0.292	-174.1	0.104	62.3	4.675	76.8	0.318	-58.3
700.00	0.285	177.1	0.118	61.7	4.056	72.0	0.324	-61.3
800.00	0.280	170.4	0.132	61.5	3.574	67.6	0.327	-64.4
900.00	0.277	163.6	0.147	60.5	3.208	63.4	0.337	-67.3
1000.00	0.272	156.7	0.161	59.6	2.902	59.4	0.346	-70.1
1100.00	0.266	150.8	0.176	58.6	2.657	55.7	0.355	-72.7
1200.00	0.263	145.5	0.190	57.6	2.454	52.2	0.367	-75.2
1300.00	0.259	139.6	0.203	56.0	2.281	48.6	0.377	-77.7
1400.00	0.256	133.4	0.216	54.8	2.129	45.3	0.390	-79.8
1500.00	0.254	128.1	0.231	53.6	2.006	42.0	0.404	-82.5
1600.00	0.253	122.1	0.244	52.1	1.898	38.7	0.416	-84.9
1700.00	0.252	116.8	0.258	50.5	1.792	35.6	0.423	-86.7
1800.00	0.251	111.4	0.270	48.9	1.706	32.7	0.439	-88.6
1900.00	0.251	105.7	0.283	47.4	1.631	29.8	0.450	-90.7
2000.00	0.253	100.7	0.295	46.1	1.561	27.0	0.465	-93.3



*Marketing division, Marketing planning department*

6-41 Tsukuba, Isahaya, Nagasaki, 854-0065 Japan

**Keep safety first in your circuit designs!**

•ISAHAYA Electronics Corporation puts the maximum effort into making semiconductor products better and more reliable, but there is always the possibility that trouble may occur with them. Trouble with semiconductors may lead to personal injury, fire or property damage. Remember to give due consideration to safety when making your circuit designs, with appropriate measures such as (1) placement of substitutive, auxiliary, (2) use of non-flammable material or (3) prevention against any malfunction or mishap.

**Notes regarding these materials**

- These materials are intended as a reference to our customers in the selection of the ISAHAYA products best suited to the customer's application; they don't convey any license under any intellectual property rights, or any other rights, belonging ISAHAYA or third party.
- ISAHAYA Electronics Corporation assumes no responsibility for any damage, or infringement of any third party's rights, originating in the use of any product data, diagrams, charts or circuit application examples contained in these materials.
- All information contained in these materials, including product data, diagrams and charts, represent information on products at the time of publication of these materials, and are subject to change by ISAHAYA Electronics Corporation without notice due to product improvements or other reasons. It is therefore recommended that customers contact ISAHAYA Electronics Corporation or an authorized ISAHAYA products distributor for the latest product information before purchasing product listed herein.
- ISAHAYA Electronics Corporation products are not designed or manufactured for use in a device or system that is used under circumstances in which human life is potentially at stake. Please contact ISAHAYA electronics corporation or an authorized ISAHAYA products distributor when considering the use of a product contained herein for any specific purposes, such as apparatus or systems for transportation, vehicular, medical, aerospace, nuclear, or undersea repeater use.
- The prior written approval of ISAHAYA Electronics Corporation is necessary to reprint or reproduce in whole or in part these materials.
- If these products or technologies are subject to the Japanese export control restrictions, they must be exported under a license from the Japanese government and cannot be imported into a country other than the approved destination. Any diversion or re-export contrary to the export control laws and regulations of Japan and/or the country of destination is prohibited.
- Please contact ISAHAYA Electronics Corporation or authorized ISAHAYA products distributor for further details on these materials or the products contained therein.