

DATA SHEET

NEC

NPN SILICON RF TRANSISTOR 2SC5615

NPN SILICON RF TRANSISTOR FOR HIGH-FREQUENCY LOW NOISE 3-PIN LEAD-LESS MINIMOLD

FEATURES

- 1005 package employed (1.0 × 0.5 × 0.5 mm)
- NF = 1.4 dB TYP., $|S_{21e}|^2 = 12.0$ dB TYP. @ $V_{CE} = 3$ V, $I_c = 7$ mA, $f = 1$ GHz

ORDERING INFORMATION

Part Number	Quantity	Supplying Form
2SC5615	50 pcs (Non reel)	• 8 mm wide embossed taping
2SC5615-T3	10 kpcs/reel	• Pin 2 (Base) face the perforation side of the tape

Remark To order evaluation samples, consult your NEC sales representative.
Unit sample quantity is 50 pcs.

ABSOLUTE MAXIMUM RATINGS (T_A = +25°C)

Parameter	Symbol	Ratings	Unit
Collector to Base Voltage	V _{CBO}	20	V
Collector to Emitter Voltage	V _{CEO}	10	V
Emitter to Base Voltage	V _{EBO}	1.5	V
Collector Current	I _c	65	mA
Total Power Dissipation	P _{tot} ^{Note}	140	mW
Junction Temperature	T _j	150	°C
Storage Temperature	T _{stg}	-65 to +150	°C

Note Mounted on 1.08 cm² × 1.0 mm (t) glass epoxy substrate

Because this product uses high-frequency technology, avoid excessive static electricity, etc.

The information in this document is subject to change without notice. Before using this document, please confirm that this is the latest version.
Not all devices/types available in every country. Please check with local NEC representative for availability and additional information.

ELECTRICAL CHARACTERISTICS (T_A = +25°C)

Parameter	Symbol	Test Conditions	MIN.	TYP.	MAX.	Unit
DC Characteristics						
Collector Cut-off Current	I _{CBO}	V _{CB} = 10 V, I _E = 0 mA	–	–	800	nA
Emitter Cut-off Current	I _{EBO}	V _{BE} = 1 V, I _C = 0 mA	–	–	800	nA
DC Current Gain	h _{FE} ^{Note 1}	V _{CE} = 3 V, I _C = 7 mA	80	–	145	–
RF Characteristics						
Gain Bandwidth Product	f _T	V _{CE} = 3 V, I _C = 7 mA, f = 1 GHz	4.5	7.0	–	GHz
Insertion Power Gain	S _{21e} ²	V _{CE} = 3 V, I _C = 7 mA, f = 1 GHz	10.0	12.0	–	dB
Noise Figure	NF	V _{CE} = 3 V, I _C = 7 mA, f = 1 GHz, Z _S = Z _{opt}	–	1.4	2.7	dB
Reverse Transfer Capacitance	C _{re} ^{Note 2}	V _{CB} = 3 V, I _E = 0 mA, f = 1 MHz	–	–	0.9	pF

- Notes** 1. Pulse measurement: PW ≤ 350 μs, Duty Cycle ≤ 2%
 2. Collector to base capacitance when the emitter grounded

h_{FE} CLASSIFICATION

Rank	EB	FB
Marking	D1	D2
h _{FE} Value	80 to 110	100 to 145

TYPICAL CHARACTERISTICS (Unless otherwise specified, $T_A = +25^\circ\text{C}$)

TOTAL POWER DISSIPATION vs. AMBIENT TEMPERATURE

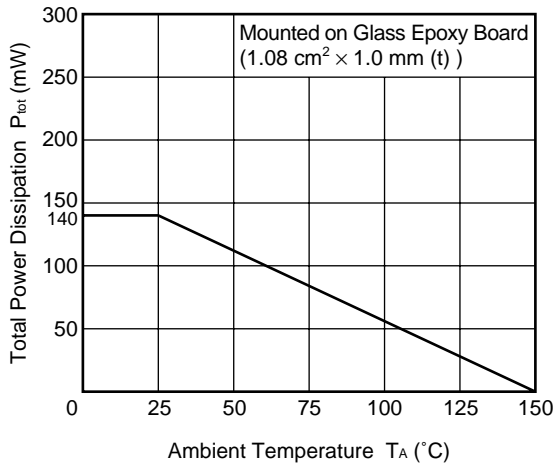

REVERSE TRANSFER CAPACITANCE vs. COLLECTOR TO BASE VOLTAGE

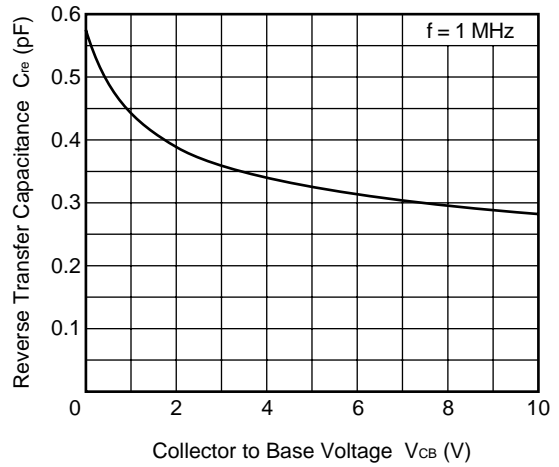

COLLECTOR CURRENT vs. BASE TO EMITTER VOLTAGE

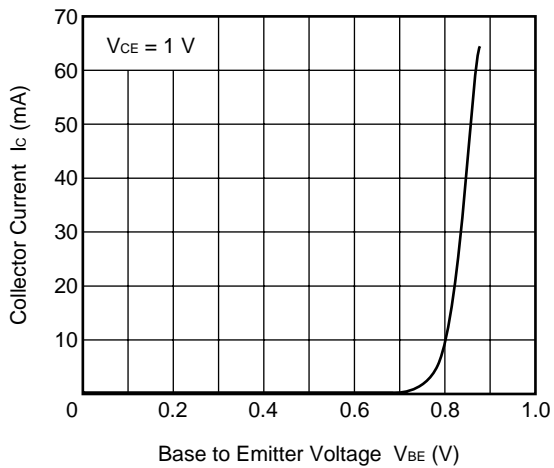

COLLECTOR CURRENT vs. BASE TO EMITTER VOLTAGE

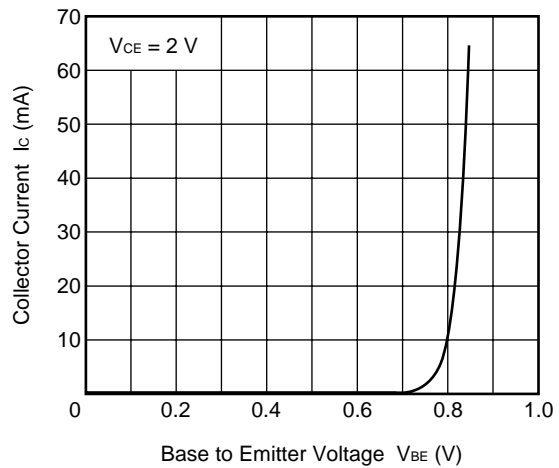

COLLECTOR CURRENT vs. BASE TO EMITTER VOLTAGE

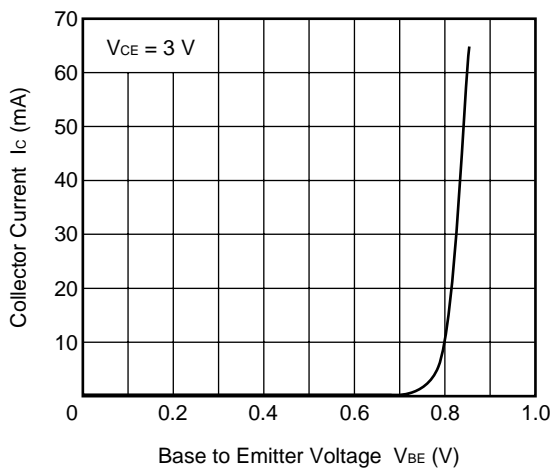

COLLECTOR CURRENT vs. COLLECTOR TO EMITTER VOLTAGE

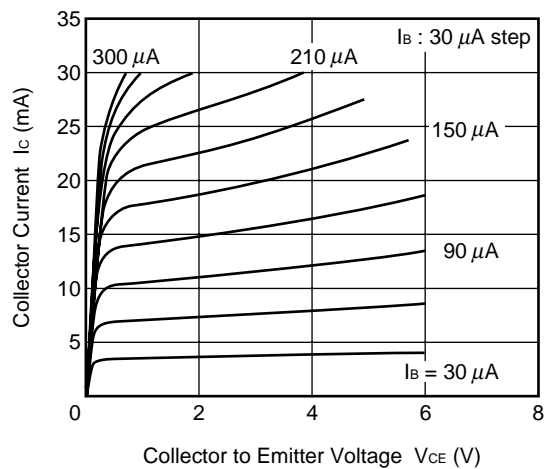

DC CURRENT GAIN vs.
COLLECTOR CURRENT

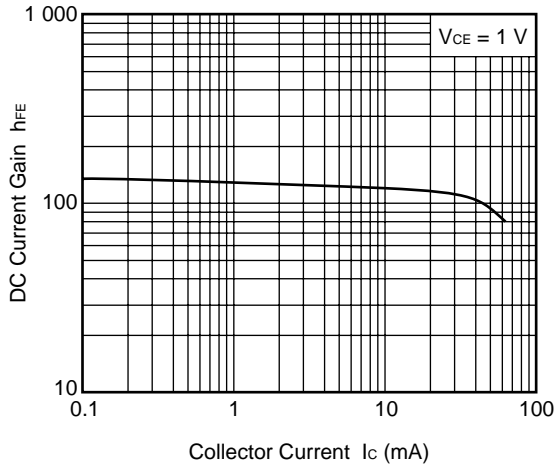

DC CURRENT GAIN vs.
COLLECTOR CURRENT

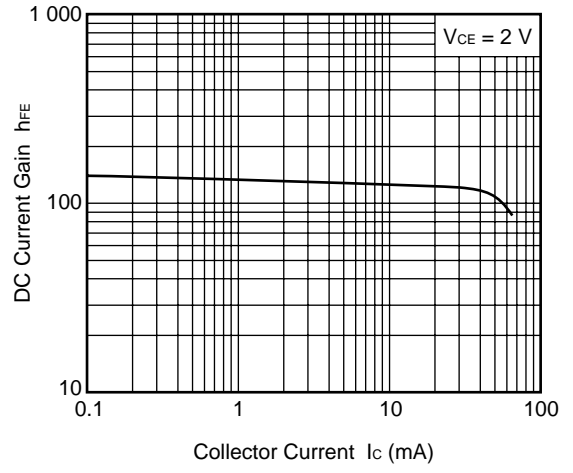

DC CURRENT GAIN vs.
COLLECTOR CURRENT

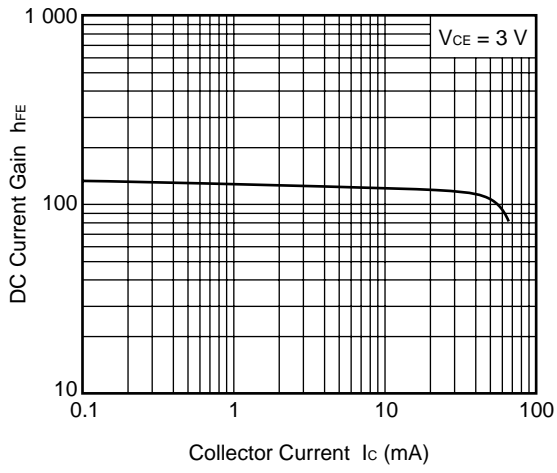

GAIN BANDWIDTH PRODUCT
vs. COLLECTOR CURRENT

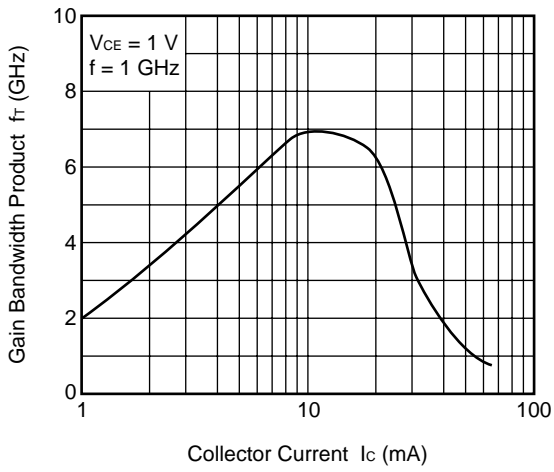

GAIN BANDWIDTH PRODUCT
vs. COLLECTOR CURRENT

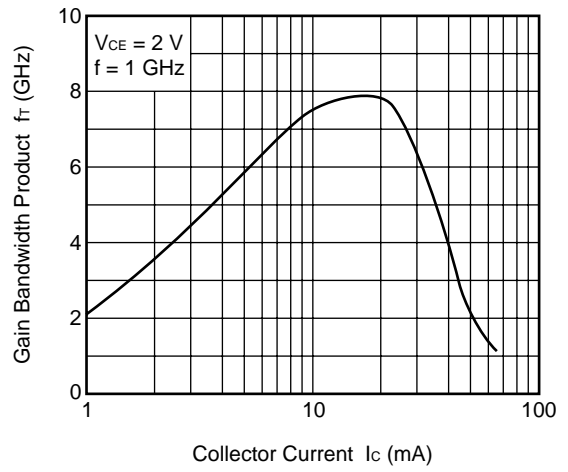

GAIN BANDWIDTH PRODUCT
vs. COLLECTOR CURRENT

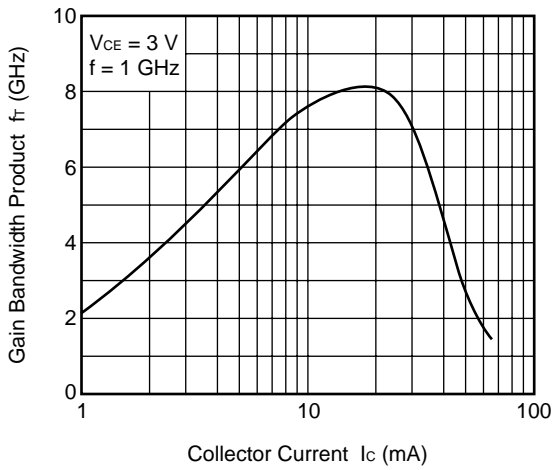

INSERTION POWER GAIN vs. FREQUENCY

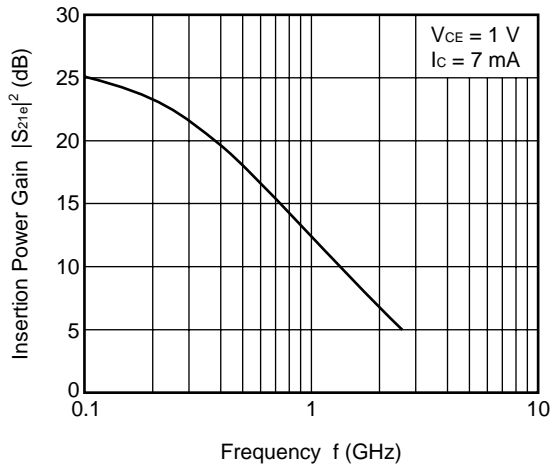

INSERTION POWER GAIN vs. FREQUENCY

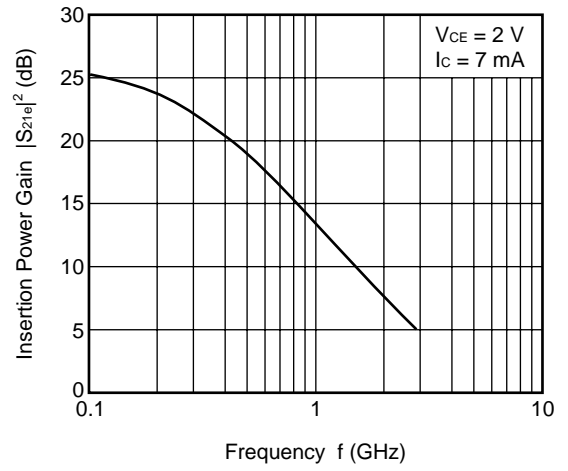

INSERTION POWER GAIN vs. FREQUENCY

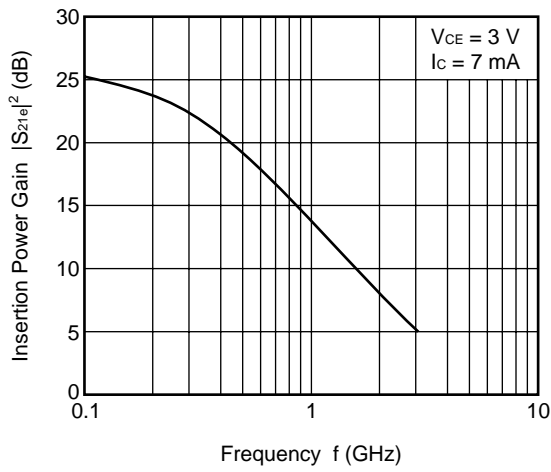

INSERTION POWER GAIN, MAG, MSG vs. COLLECTOR CURRENT

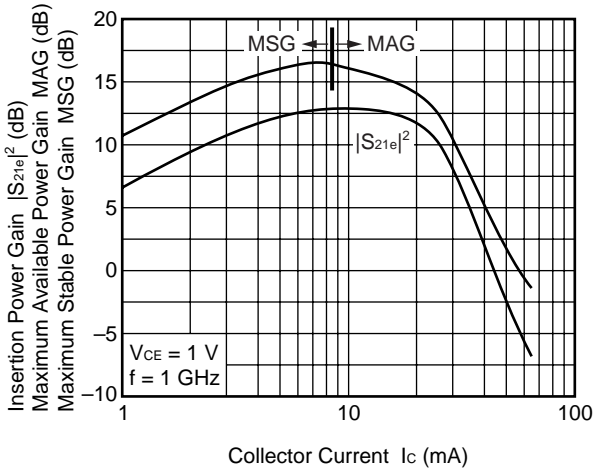

INSERTION POWER GAIN, MAG, MSG vs. COLLECTOR CURRENT

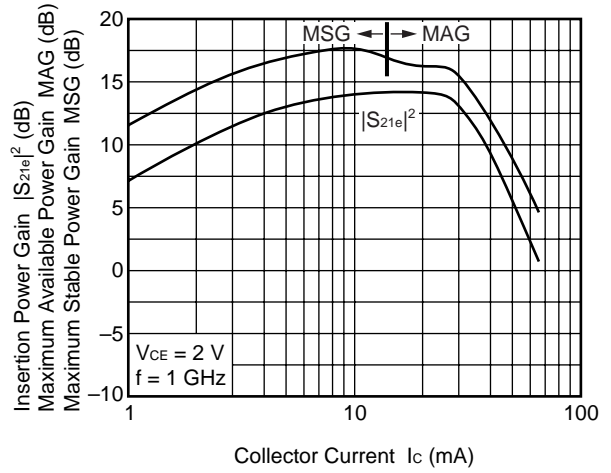

INSERTION POWER GAIN, MAG vs. COLLECTOR CURRENT

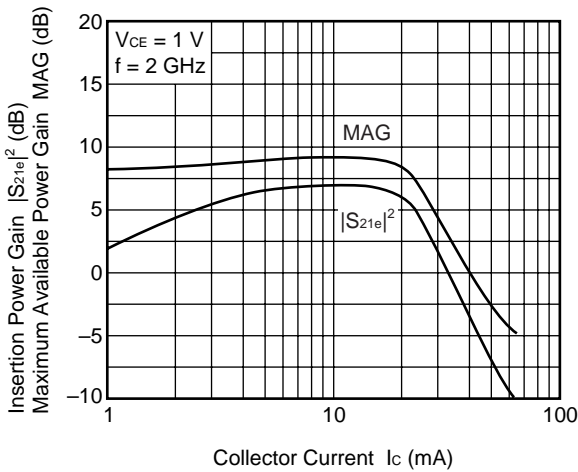

INSERTION POWER GAIN, MAG, MSG vs. COLLECTOR CURRENT

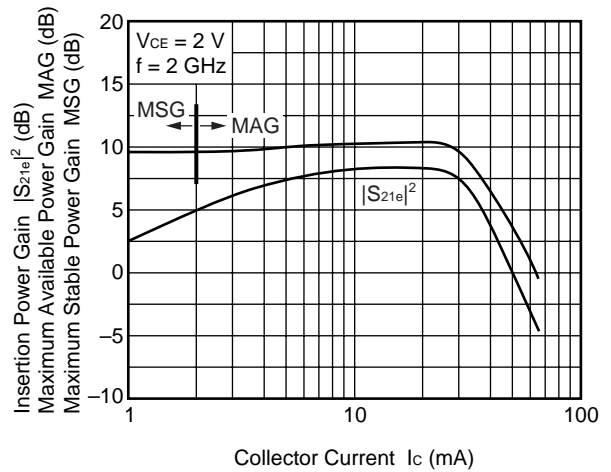

INSERTION POWER GAIN, MAG vs. COLLECTOR CURRENT

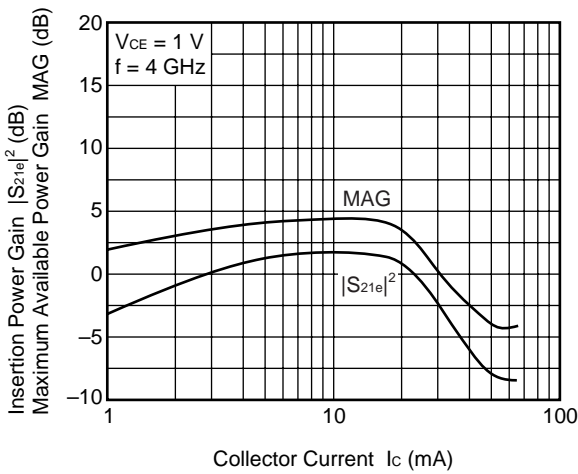

INSERTION POWER GAIN, MAG vs. COLLECTOR CURRENT

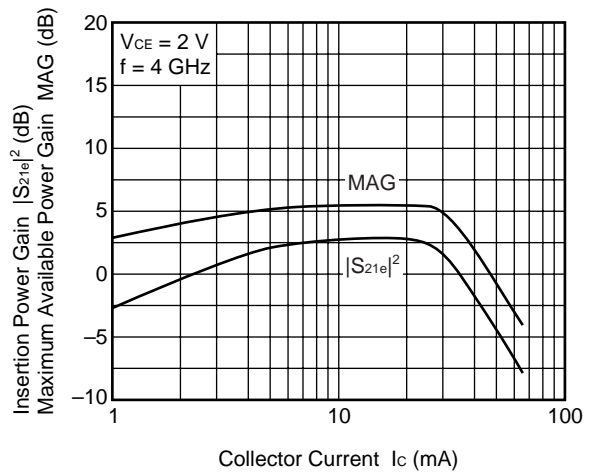

INSERTION POWER GAIN, MAG, MSG
vs. COLLECTOR CURRENT

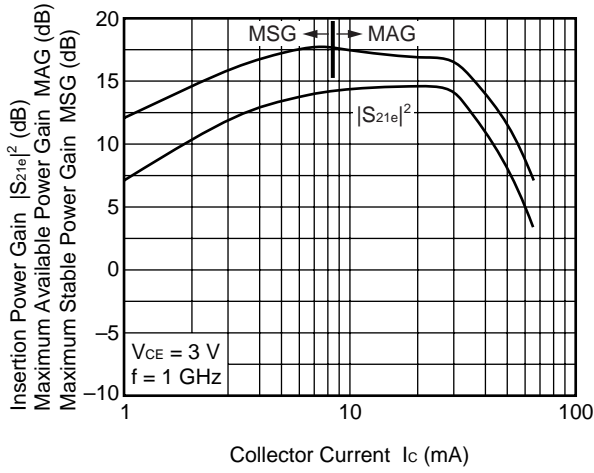

INSERTION POWER GAIN, MAG
vs. COLLECTOR CURRENT

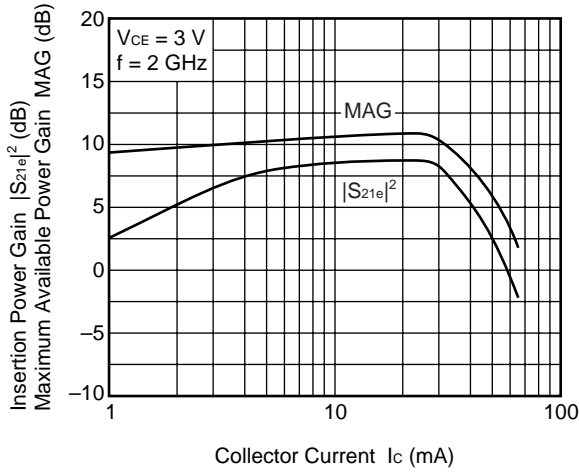

INSERTION POWER GAIN, MAG
vs. COLLECTOR CURRENT

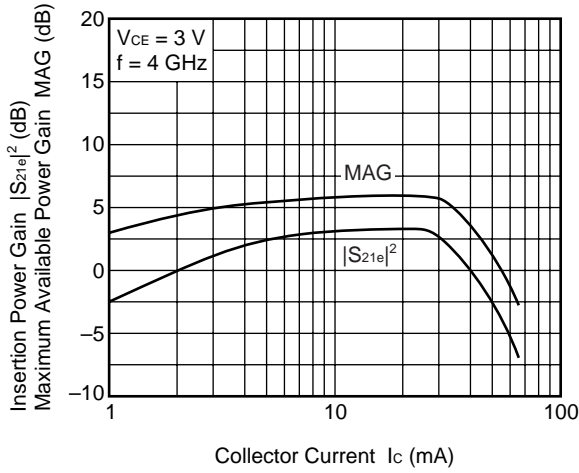

NOISE FIGURE, ASSOCIATED GAIN vs. COLLECTOR CURRENT

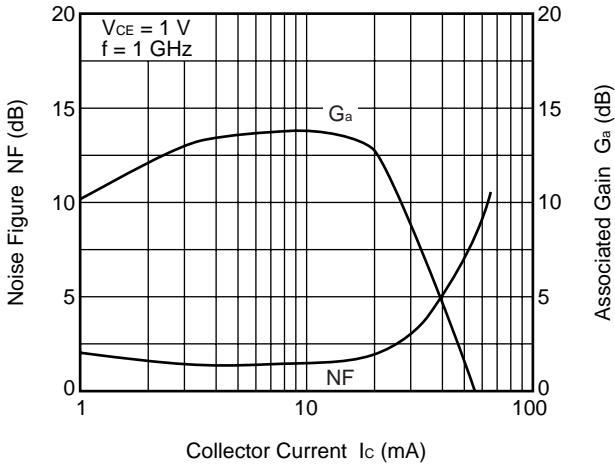

NOISE FIGURE, ASSOCIATED GAIN vs. COLLECTOR CURRENT

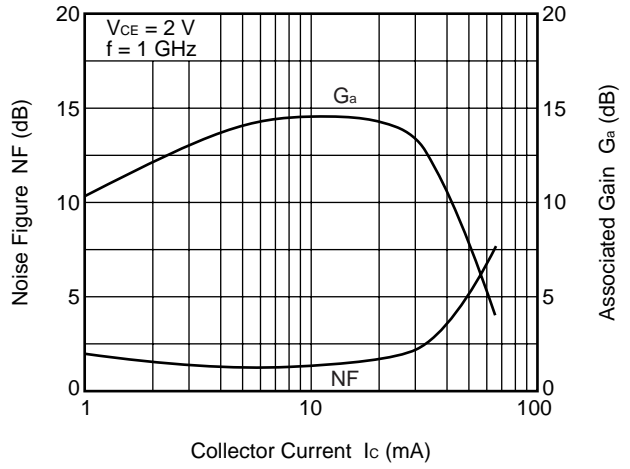

NOISE FIGURE, ASSOCIATED GAIN vs. COLLECTOR CURRENT

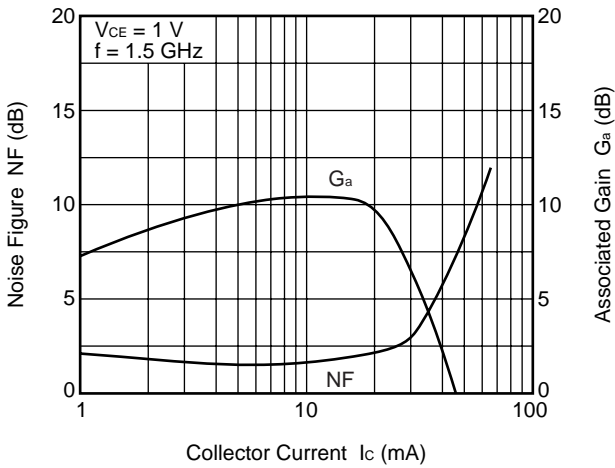

NOISE FIGURE, ASSOCIATED GAIN vs. COLLECTOR CURRENT

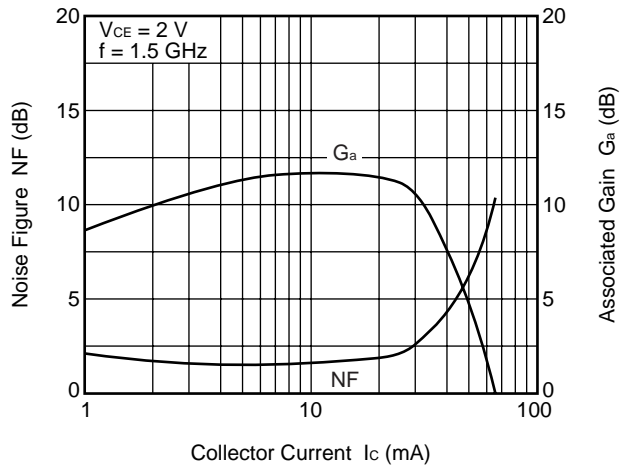

NOISE FIGURE, ASSOCIATED GAIN vs. COLLECTOR CURRENT

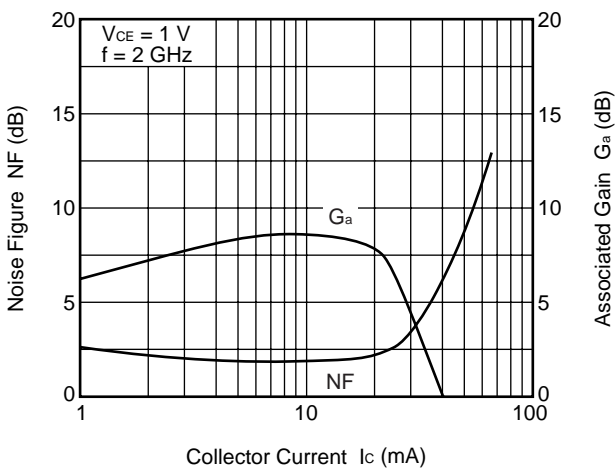

NOISE FIGURE, ASSOCIATED GAIN vs. COLLECTOR CURRENT

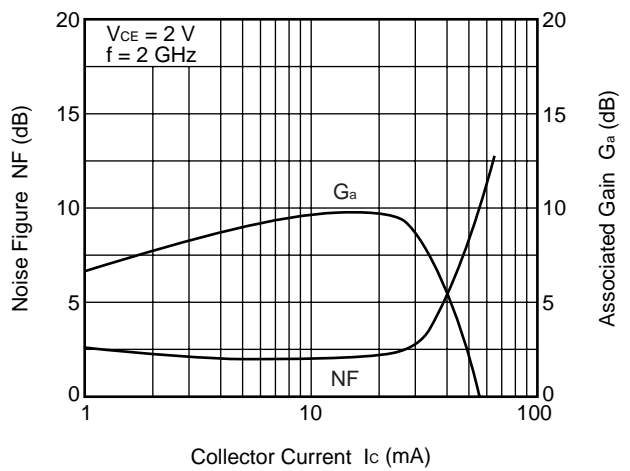

NOISE FIGURE, ASSOCIATED GAIN vs. COLLECTOR CURRENT

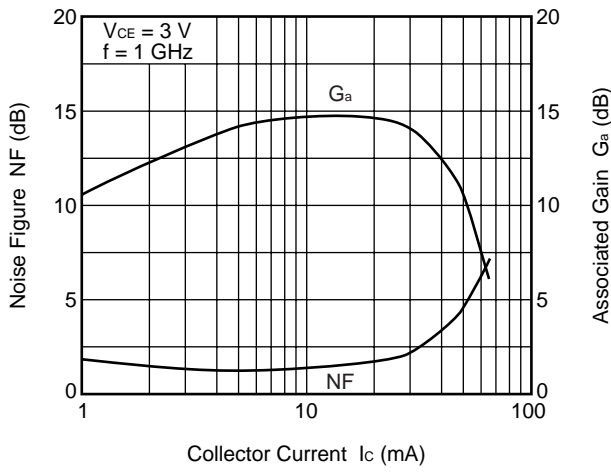

NOISE FIGURE, ASSOCIATED GAIN vs. COLLECTOR CURRENT

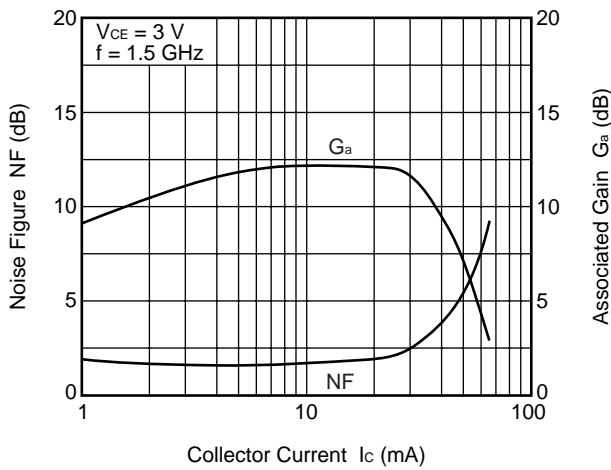

NOISE FIGURE, ASSOCIATED GAIN vs. COLLECTOR CURRENT

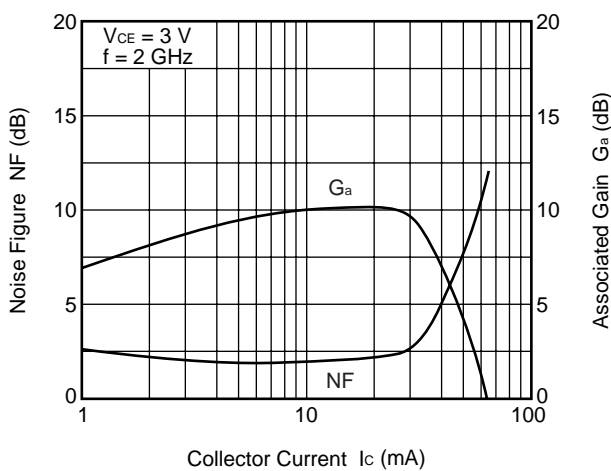

Remark The graphs indicate nominal characteristics.

S-PARAMETERS

Note When $K \geq 1$, the MAG (Maximum Available Power Gain) is used. $MAG = \left| \frac{S_{21}}{S_{12}} \right| (K - \sqrt{K^2 - 1})$

When $K < 1$, the MSG (Maximum Stable Power Gain) is used. $MSG = \left| \frac{S_{21}}{S_{12}} \right|$

$V_{CE} = 1\text{ V}$, $I_C = 1\text{ mA}$, $Z_O = 50\ \Omega$

Frequency (GHz)	S ₁₁		S ₂₁		S ₁₂		S ₂₂		K	MAG/MSG (dB) ^{Note}
	MAG.	ANG. (deg.)	MAG.	ANG. (deg.)	MAG.	ANG. (deg.)	MAG.	ANG. (deg.)		
0.1	0.963	-14.7	3.585	168.4	0.031	80.2	1.002	-5.2	0.080	20.58
0.2	0.957	-27.6	3.456	159.3	0.064	73.9	0.976	-10.8	0.093	17.30
0.3	0.904	-41.7	3.289	149.9	0.092	66.1	0.951	-15.7	0.130	15.52
0.4	0.885	-54.8	3.140	139.9	0.117	58.8	0.906	-20.5	0.180	14.30
0.5	0.848	-66.8	3.002	131.5	0.137	52.2	0.869	-24.5	0.225	13.41
0.6	0.797	-78.2	2.788	123.2	0.152	46.3	0.813	-28.2	0.291	12.63
0.7	0.762	-88.9	2.618	116.4	0.164	41.5	0.777	-31.1	0.327	12.04
0.8	0.727	-98.7	2.442	109.5	0.171	37.0	0.730	-33.8	0.389	11.54
0.9	0.700	-108.0	2.273	104.1	0.177	33.2	0.697	-36.2	0.429	11.08
1.0	0.681	-116.5	2.130	98.6	0.181	30.1	0.660	-38.4	0.480	10.71
1.1	0.661	-124.7	1.996	93.2	0.183	27.2	0.642	-40.6	0.522	10.38
1.2	0.648	-132.4	1.884	88.3	0.184	25.0	0.614	-42.3	0.573	10.11
1.3	0.639	-138.8	1.769	84.0	0.184	22.6	0.604	-44.3	0.610	9.83
1.4	0.625	-145.5	1.673	79.5	0.183	20.7	0.583	-46.0	0.676	9.62
1.5	0.619	-151.0	1.582	75.8	0.181	19.4	0.577	-47.9	0.714	9.41
1.6	0.614	-156.8	1.503	71.7	0.179	18.1	0.559	-49.4	0.781	9.25
1.7	0.616	-161.7	1.434	68.6	0.176	17.3	0.553	-51.3	0.816	9.11
1.8	0.611	-166.8	1.363	64.6	0.172	16.9	0.538	-52.6	0.898	8.99
1.9	0.610	-170.6	1.307	62.1	0.168	16.6	0.532	-54.5	0.952	8.90
2.0	0.617	-174.9	1.245	58.8	0.165	17.0	0.521	-56.1	1.007	8.27
2.1	0.624	-178.8	1.201	56.1	0.162	17.4	0.517	-58.4	1.040	7.48
2.2	0.623	177.7	1.172	53.9	0.158	18.3	0.509	-60.0	1.093	6.85
2.3	0.626	174.4	1.125	51.0	0.155	19.2	0.510	-62.4	1.142	6.33
2.4	0.630	170.9	1.090	49.4	0.152	20.2	0.505	-64.3	1.190	5.94
2.5	0.634	168.0	1.044	47.2	0.149	21.7	0.505	-66.8	1.241	5.50
2.6	0.638	165.0	1.012	44.4	0.146	22.5	0.504	-69.1	1.288	5.19
2.7	0.640	162.4	0.989	42.5	0.145	24.4	0.503	-71.6	1.316	4.98
2.8	0.647	159.5	0.954	40.3	0.144	26.2	0.502	-73.3	1.345	4.70
2.9	0.650	157.4	0.925	38.7	0.146	29.0	0.499	-75.5	1.360	4.44
3.0	0.651	154.5	0.895	37.0	0.146	31.5	0.492	-77.4	1.417	4.02
4.0	0.681	131.0	0.690	22.0	0.200	51.5	0.481	-102.3	1.330	1.94
5.0	0.740	113.4	0.584	13.6	0.313	50.1	0.467	-134.8	1.030	1.65

$V_{CE} = 1\text{ V}$, $I_C = 3\text{ mA}$, $Z_o = 50\ \Omega$

Frequency (GHz)	S ₁₁		S ₂₁		S ₁₂		S ₂₂		K	MAG/MSG (dB)
	MAG.	ANG. (deg.)	MAG.	ANG. (deg.)	MAG.	ANG. (deg.)	MAG.	ANG. (deg.)		
0.1	0.867	-25.0	9.574	162.5	0.031	74.5	0.970	-11.7	0.119	24.94
0.2	0.840	-45.3	8.765	148.0	0.058	66.1	0.893	-22.0	0.164	21.77
0.3	0.753	-65.7	7.735	135.9	0.077	57.3	0.807	-30.0	0.228	19.99
0.4	0.704	-83.0	6.860	124.8	0.092	50.5	0.713	-36.0	0.306	18.72
0.5	0.656	-97.7	6.089	116.1	0.102	45.5	0.638	-40.2	0.377	17.76
0.6	0.603	-110.0	5.346	108.7	0.109	42.1	0.566	-43.5	0.471	16.92
0.7	0.573	-121.1	4.807	103.0	0.114	40.1	0.518	-45.5	0.533	16.26
0.8	0.548	-130.6	4.302	97.4	0.117	38.5	0.469	-47.5	0.615	15.65
0.9	0.537	-139.4	3.895	93.4	0.121	37.4	0.435	-49.3	0.671	15.09
1.0	0.532	-146.7	3.566	89.3	0.124	37.0	0.402	-50.9	0.730	14.60
1.1	0.521	-153.7	3.269	85.3	0.126	36.9	0.384	-52.4	0.790	14.14
1.2	0.519	-159.8	3.034	81.6	0.129	37.2	0.361	-53.9	0.841	13.72
1.3	0.519	-164.7	2.816	78.5	0.131	37.1	0.352	-55.3	0.884	13.31
1.4	0.514	-170.2	2.630	75.0	0.134	37.5	0.334	-56.5	0.945	12.94
1.5	0.515	-174.4	2.467	72.4	0.137	38.1	0.330	-57.9	0.977	12.56
1.6	0.515	-179.2	2.322	69.3	0.139	38.7	0.313	-59.0	1.028	11.19
1.7	0.521	177.4	2.204	67.0	0.142	39.1	0.309	-60.5	1.050	10.53
1.8	0.522	172.9	2.085	64.0	0.145	40.0	0.296	-61.5	1.097	9.69
1.9	0.523	170.7	1.994	61.8	0.148	40.6	0.292	-63.5	1.123	9.17
2.0	0.533	167.4	1.887	59.2	0.151	41.5	0.281	-64.7	1.147	8.63
2.1	0.538	165.0	1.812	57.1	0.155	42.2	0.279	-67.2	1.157	8.28
2.2	0.543	162.7	1.756	55.3	0.159	43.0	0.272	-68.6	1.164	7.99
2.3	0.543	160.1	1.688	52.8	0.163	43.7	0.272	-71.2	1.179	7.60
2.4	0.551	157.4	1.633	51.5	0.166	44.1	0.267	-72.7	1.184	7.33
2.5	0.556	155.3	1.562	49.7	0.171	44.8	0.267	-75.5	1.193	6.96
2.6	0.561	152.9	1.512	47.1	0.175	44.8	0.265	-77.0	1.194	6.71
2.7	0.563	150.8	1.476	45.6	0.179	45.3	0.265	-79.6	1.192	6.51
2.8	0.570	149.0	1.426	43.6	0.184	45.4	0.263	-80.7	1.186	6.28
2.9	0.571	147.4	1.381	42.3	0.191	46.0	0.261	-83.5	1.185	5.98
3.0	0.572	144.9	1.336	40.4	0.196	46.5	0.255	-84.8	1.199	5.62
4.0	0.609	126.6	1.033	24.2	0.257	47.8	0.252	-111.2	1.159	3.62
5.0	0.684	112.6	0.868	11.5	0.336	42.4	0.246	-146.4	0.997	4.12

$V_{CE} = 1\text{ V}$, $I_C = 5\text{ mA}$, $Z_o = 50\ \Omega$

Frequency (GHz)	S ₁₁		S ₂₁		S ₁₂		S ₂₂		K	MAG/MSG (dB)
	MAG.	ANG. (deg.)	MAG.	ANG. (deg.)	MAG.	ANG. (deg.)	MAG.	ANG. (deg.)		
0.1	0.798	-32.2	14.320	157.3	0.029	72.5	0.935	-17.0	0.146	26.92
0.2	0.745	-59.4	12.340	139.6	0.052	61.6	0.809	-30.3	0.227	23.73
0.3	0.645	-83.5	10.266	126.8	0.066	53.4	0.688	-38.8	0.328	21.89
0.4	0.597	-101.2	8.656	116.0	0.076	48.8	0.579	-44.7	0.428	20.55
0.5	0.558	-116.0	7.415	108.0	0.083	45.8	0.503	-47.9	0.518	19.50
0.6	0.520	-128.0	6.367	101.7	0.089	44.6	0.434	-50.6	0.621	18.55
0.7	0.500	-138.5	5.619	96.8	0.094	44.3	0.390	-52.0	0.696	17.79
0.8	0.488	-147.1	4.981	92.0	0.098	44.3	0.349	-53.8	0.774	17.07
0.9	0.484	-154.4	4.475	88.7	0.102	44.4	0.321	-55.3	0.831	16.42
1.0	0.485	-160.8	4.064	85.2	0.107	45.1	0.293	-56.9	0.883	15.80
1.1	0.481	-166.9	3.705	81.8	0.111	45.8	0.279	-58.3	0.932	15.22
1.2	0.484	-172.0	3.430	78.7	0.116	46.5	0.260	-59.9	0.969	14.70
1.3	0.486	-176.2	3.174	76.0	0.121	46.9	0.254	-61.3	1.000	14.08
1.4	0.488	179.4	2.953	73.0	0.125	47.4	0.239	-62.7	1.041	12.49
1.5	0.489	175.9	2.771	70.7	0.131	48.1	0.236	-64.1	1.059	11.78
1.6	0.493	171.6	2.601	67.9	0.135	48.6	0.221	-65.3	1.091	11.00
1.7	0.499	169.0	2.460	65.9	0.141	48.9	0.219	-67.0	1.098	10.51
1.8	0.503	165.2	2.331	63.2	0.146	49.4	0.206	-68.2	1.122	9.92
1.9	0.500	162.9	2.228	61.4	0.151	49.8	0.204	-70.4	1.139	9.42
2.0	0.513	160.3	2.108	58.9	0.157	50.2	0.194	-71.9	1.144	8.98
2.1	0.520	158.2	2.022	56.8	0.162	50.3	0.193	-75.0	1.143	8.67
2.2	0.523	156.5	1.957	55.2	0.168	50.7	0.186	-76.5	1.144	8.36
2.3	0.525	154.4	1.882	52.8	0.174	50.7	0.187	-79.8	1.147	8.02
2.4	0.530	151.8	1.815	51.7	0.179	50.7	0.182	-81.1	1.151	7.71
2.5	0.536	150.1	1.737	50.0	0.185	50.8	0.183	-84.5	1.154	7.35
2.6	0.541	148.0	1.681	47.6	0.190	50.4	0.181	-85.9	1.150	7.12
2.7	0.544	146.4	1.640	46.0	0.196	50.3	0.182	-89.0	1.142	6.94
2.8	0.552	144.5	1.584	44.3	0.202	50.0	0.179	-89.9	1.135	6.71
2.9	0.552	143.4	1.539	43.1	0.210	49.9	0.179	-93.2	1.130	6.46
3.0	0.553	141.0	1.488	41.5	0.216	49.8	0.173	-94.5	1.141	6.10
4.0	0.589	124.6	1.146	25.6	0.278	47.1	0.178	-124.6	1.120	4.04
5.0	0.664	111.8	0.968	12.6	0.349	40.0	0.184	-164.0	1.000	4.43

$V_{CE} = 1\text{ V}$, $I_C = 7\text{ mA}$, $Z_o = 50\ \Omega$

Frequency (GHz)	S ₁₁		S ₂₁		S ₁₂		S ₂₂		K	MAG/MSG (dB)
	MAG.	ANG. (deg.)	MAG.	ANG. (deg.)	MAG.	ANG. (deg.)	MAG.	ANG. (deg.)		
0.1	0.730	-39.4	17.993	152.9	0.027	71.9	0.901	-21.3	0.160	28.18
0.2	0.667	-71.5	14.732	133.4	0.048	58.3	0.737	-36.1	0.294	24.85
0.3	0.572	-96.4	11.715	120.9	0.059	52.0	0.600	-44.7	0.418	23.00
0.4	0.536	-114.2	9.579	110.6	0.067	49.5	0.491	-49.9	0.529	21.57
0.5	0.508	-128.5	8.034	103.4	0.074	48.2	0.419	-52.4	0.624	20.38
0.6	0.480	-139.7	6.841	97.7	0.079	48.2	0.357	-54.7	0.730	19.38
0.7	0.472	-149.2	5.995	93.4	0.084	48.6	0.319	-55.7	0.797	18.53
0.8	0.461	-156.8	5.291	89.1	0.089	49.3	0.282	-57.4	0.874	17.73
0.9	0.466	-163.5	4.728	86.1	0.095	49.9	0.259	-59.0	0.918	16.98
1.0	0.471	-169.2	4.293	83.0	0.101	50.8	0.235	-60.7	0.957	16.30
1.1	0.468	-174.3	3.906	80.0	0.106	51.6	0.224	-62.3	0.997	15.66
1.2	0.474	-178.7	3.610	77.0	0.112	52.3	0.207	-64.3	1.023	14.16
1.3	0.476	177.7	3.331	74.5	0.118	52.6	0.203	-65.8	1.047	13.18
1.4	0.478	173.5	3.095	71.8	0.124	53.0	0.189	-67.6	1.078	12.28
1.5	0.480	170.4	2.909	69.6	0.130	53.5	0.188	-68.9	1.084	11.72
1.6	0.487	166.8	2.724	67.1	0.136	53.8	0.174	-70.6	1.105	11.04
1.7	0.494	164.3	2.573	65.1	0.142	53.9	0.173	-72.4	1.108	10.57
1.8	0.495	160.7	2.438	62.6	0.148	54.2	0.161	-74.1	1.129	9.97
1.9	0.496	159.0	2.330	60.8	0.155	54.1	0.160	-76.7	1.133	9.56
2.0	0.504	156.8	2.204	58.6	0.161	54.2	0.150	-78.6	1.143	9.07
2.1	0.514	154.9	2.112	56.6	0.167	54.2	0.151	-82.2	1.134	8.79
2.2	0.517	153.3	2.043	55.1	0.174	54.1	0.145	-84.3	1.131	8.51
2.3	0.519	151.2	1.963	52.8	0.180	53.9	0.146	-87.9	1.132	8.17
2.4	0.524	149.1	1.896	51.7	0.186	53.7	0.142	-89.5	1.131	7.87
2.5	0.529	147.4	1.815	50.0	0.193	53.5	0.144	-93.5	1.134	7.52
2.6	0.535	145.5	1.753	47.8	0.199	52.8	0.142	-94.8	1.129	7.27
2.7	0.539	143.8	1.710	46.3	0.205	52.5	0.143	-98.3	1.119	7.11
2.8	0.543	142.2	1.653	44.6	0.212	51.8	0.140	-99.2	1.118	6.84
2.9	0.544	141.0	1.605	43.4	0.220	51.7	0.141	-103.2	1.114	6.58
3.0	0.546	139.0	1.553	41.8	0.226	51.4	0.136	-104.5	1.118	6.27
4.0	0.583	123.5	1.195	26.3	0.289	47.0	0.150	-137.3	1.102	4.22
5.0	0.657	111.3	1.011	13.4	0.356	39.0	0.168	-178.1	1.002	4.26

$V_{CE} = 1\text{ V}$, $I_C = 10\text{ mA}$, $Z_O = 50\ \Omega$

Frequency (GHz)	S ₁₁		S ₂₁		S ₁₂		S ₂₂		K	MAG/MSG (dB)
	MAG.	ANG. (deg.)	MAG.	ANG. (deg.)	MAG.	ANG. (deg.)	MAG.	ANG. (deg.)		
0.1	0.643	-50.4	22.066	147.8	0.026	66.5	0.850	-26.6	0.230	29.29
0.2	0.581	-85.7	16.853	126.8	0.043	56.4	0.649	-42.4	0.377	25.97
0.3	0.512	-111.8	12.827	114.8	0.051	52.5	0.506	-50.1	0.524	23.98
0.4	0.488	-128.9	10.233	105.5	0.058	51.7	0.405	-54.6	0.646	22.45
0.5	0.473	-141.4	8.463	99.0	0.065	51.6	0.341	-56.3	0.741	21.14
0.6	0.458	-151.7	7.145	94.1	0.071	52.6	0.288	-58.2	0.835	20.02
0.7	0.453	-159.6	6.224	90.2	0.077	54.0	0.255	-58.9	0.897	19.06
0.8	0.450	-166.3	5.471	86.3	0.083	54.8	0.225	-60.6	0.958	18.17
0.9	0.458	-172.1	4.888	83.8	0.090	55.3	0.206	-62.5	0.990	17.36
1.0	0.464	-176.7	4.418	80.8	0.097	56.2	0.185	-64.8	1.016	15.80
1.1	0.464	178.9	4.013	78.1	0.104	56.9	0.176	-66.5	1.048	14.55
1.2	0.469	175.1	3.707	75.4	0.111	57.4	0.162	-69.1	1.063	13.72
1.3	0.475	172.0	3.420	73.1	0.117	57.5	0.160	-70.9	1.076	12.97
1.4	0.477	168.3	3.177	70.5	0.124	57.8	0.148	-73.2	1.098	12.19
1.5	0.480	165.6	2.981	68.5	0.131	57.8	0.148	-74.7	1.101	11.63
1.6	0.486	162.2	2.794	66.1	0.138	57.9	0.136	-77.0	1.114	11.01
1.7	0.493	160.4	2.638	64.2	0.145	57.8	0.136	-79.1	1.111	10.57
1.8	0.497	157.2	2.498	61.9	0.152	57.8	0.125	-81.7	1.122	10.04
1.9	0.495	155.2	2.387	60.2	0.158	57.6	0.125	-84.8	1.130	9.59
2.0	0.507	153.6	2.255	58.0	0.166	57.4	0.117	-87.5	1.130	9.15
2.1	0.512	151.5	2.163	56.1	0.172	57.1	0.118	-91.9	1.126	8.83
2.2	0.517	150.2	2.091	54.6	0.179	56.8	0.113	-94.5	1.119	8.57
2.3	0.516	148.2	2.008	52.4	0.186	56.4	0.115	-98.9	1.124	8.19
2.4	0.526	146.2	1.939	51.3	0.192	55.9	0.112	-100.7	1.115	7.97
2.5	0.529	145.0	1.857	49.7	0.200	55.5	0.115	-105.2	1.119	7.59
2.6	0.537	143.0	1.791	47.6	0.206	54.8	0.113	-106.7	1.111	7.36
2.7	0.537	141.6	1.747	46.1	0.213	54.2	0.116	-110.7	1.108	7.14
2.8	0.544	140.0	1.690	44.5	0.219	53.5	0.113	-111.9	1.101	6.93
2.9	0.546	139.0	1.639	43.4	0.228	53.1	0.115	-115.9	1.096	6.68
3.0	0.546	136.9	1.588	41.7	0.234	52.5	0.110	-117.9	1.101	6.37
4.0	0.584	122.1	1.222	26.4	0.298	46.9	0.136	-151.2	1.088	4.32
5.0	0.655	110.8	1.034	13.7	0.362	38.2	0.167	168.9	1.001	4.33

$V_{CE} = 1\text{ V}$, $I_C = 20\text{ mA}$, $Z_0 = 50\ \Omega$

Frequency (GHz)	S ₁₁		S ₂₁		S ₁₂		S ₂₂		K	MAG/MSG (dB)
	MAG.	ANG. (deg.)	MAG.	ANG. (deg.)	MAG.	ANG. (deg.)	MAG.	ANG. (deg.)		
0.1	0.506	-87.1	26.273	134.7	0.022	60.5	0.674	-38.8	0.375	30.83
0.2	0.499	-123.7	17.288	113.5	0.034	54.0	0.443	-53.3	0.594	27.05
0.3	0.488	-145.1	12.306	104.0	0.041	55.7	0.326	-57.6	0.774	24.82
0.4	0.488	-156.3	9.484	96.7	0.048	57.8	0.253	-59.9	0.889	22.96
0.5	0.491	-164.7	7.710	91.5	0.056	59.2	0.212	-59.5	0.958	21.41
0.6	0.489	-171.8	6.453	87.6	0.063	60.7	0.176	-61.0	1.028	19.07
0.7	0.491	-177.4	5.594	84.5	0.071	62.3	0.157	-60.9	1.064	17.43
0.8	0.492	178.2	4.898	81.2	0.078	63.0	0.137	-63.6	1.103	16.00
0.9	0.504	174.6	4.369	79.0	0.086	63.3	0.126	-66.2	1.112	15.02
1.0	0.510	171.2	3.946	76.4	0.094	63.6	0.112	-70.0	1.124	14.08
1.1	0.512	167.9	3.586	73.8	0.102	64.0	0.109	-72.7	1.137	13.20
1.2	0.517	165.0	3.299	71.4	0.110	64.1	0.100	-77.3	1.147	12.45
1.3	0.520	162.8	3.050	69.2	0.118	63.8	0.102	-79.9	1.151	11.78
1.4	0.525	160.0	2.828	66.8	0.125	63.6	0.094	-84.2	1.161	11.10
1.5	0.528	157.9	2.652	65.0	0.134	63.4	0.097	-86.1	1.158	10.57
1.6	0.534	155.3	2.485	62.6	0.141	63.1	0.089	-90.6	1.163	10.00
1.7	0.541	153.8	2.349	60.9	0.149	62.6	0.091	-93.3	1.156	9.59
1.8	0.547	150.9	2.223	58.6	0.157	62.2	0.083	-98.5	1.158	9.12
1.9	0.544	149.4	2.127	57.0	0.164	61.8	0.086	-102.4	1.163	8.69
2.0	0.556	147.8	2.007	54.9	0.172	61.3	0.081	-107.8	1.157	8.27
2.1	0.561	146.6	1.923	53.0	0.179	60.7	0.087	-112.3	1.152	7.95
2.2	0.562	145.3	1.864	51.6	0.187	60.2	0.084	-116.8	1.145	7.68
2.3	0.563	143.5	1.790	49.3	0.194	59.5	0.089	-121.3	1.144	7.34
2.4	0.569	141.7	1.730	48.3	0.201	58.8	0.088	-123.9	1.138	7.09
2.5	0.575	140.3	1.656	46.8	0.209	58.1	0.095	-127.7	1.135	6.77
2.6	0.580	138.8	1.598	44.6	0.216	57.2	0.093	-130.0	1.129	6.52
2.7	0.580	137.4	1.562	43.2	0.223	56.4	0.099	-133.6	1.124	6.32
2.8	0.589	136.1	1.512	41.6	0.230	55.5	0.097	-135.5	1.112	6.15
2.9	0.590	134.8	1.468	40.5	0.238	55.0	0.102	-139.1	1.107	5.90
3.0	0.589	133.1	1.419	39.0	0.245	54.3	0.099	-142.0	1.115	5.56
4.0	0.617	119.1	1.093	24.1	0.311	47.2	0.143	-169.4	1.109	3.45
5.0	0.683	107.9	0.928	11.9	0.375	37.6	0.192	156.7	1.020	3.08

$V_{CE} = 2\text{ V}$, $I_C = 1\text{ mA}$, $Z_o = 50\ \Omega$

Frequency (GHz)	S ₁₁		S ₂₁		S ₁₂		S ₂₂		K	MAG/MSG (dB)
	MAG.	ANG. (deg.)	MAG.	ANG. (deg.)	MAG.	ANG. (deg.)	MAG.	ANG. (deg.)		
0.1	0.955	-13.8	3.624	169.0	0.027	79.6	1.001	-4.2	0.104	21.34
0.2	0.957	-25.2	3.510	160.9	0.053	75.2	0.982	-8.9	0.097	18.22
0.3	0.914	-38.7	3.353	152.2	0.075	67.9	0.962	-13.0	0.123	16.48
0.4	0.894	-51.0	3.226	142.8	0.097	61.4	0.925	-17.1	0.169	15.24
0.5	0.857	-62.6	3.105	134.8	0.114	55.1	0.897	-20.5	0.210	14.35
0.6	0.812	-73.4	2.905	126.7	0.128	49.3	0.848	-23.7	0.277	13.56
0.7	0.775	-84.0	2.747	120.2	0.139	44.8	0.817	-26.3	0.307	12.97
0.8	0.740	-93.4	2.573	113.3	0.145	40.4	0.774	-28.7	0.372	12.48
0.9	0.710	-102.7	2.403	108.1	0.151	36.7	0.744	-30.9	0.410	12.01
1.0	0.687	-111.2	2.263	102.6	0.155	33.6	0.709	-32.7	0.463	11.64
1.1	0.666	-119.5	2.128	97.2	0.157	30.9	0.692	-34.7	0.503	11.31
1.2	0.655	-127.2	2.016	92.4	0.158	28.7	0.666	-36.3	0.547	11.05
1.3	0.641	-133.9	1.891	88.2	0.159	26.3	0.656	-38.0	0.591	10.76
1.4	0.626	-140.7	1.791	83.5	0.158	24.6	0.636	-39.4	0.656	10.55
1.5	0.617	-146.7	1.698	80.0	0.157	23.4	0.631	-41.2	0.690	10.34
1.6	0.609	-152.8	1.613	75.9	0.155	22.3	0.614	-42.5	0.760	10.18
1.7	0.613	-157.8	1.541	72.8	0.153	21.4	0.608	-44.3	0.788	10.03
1.8	0.602	-163.3	1.467	68.8	0.150	21.2	0.594	-45.4	0.875	9.91
1.9	0.599	-167.4	1.401	66.3	0.146	21.1	0.586	-47.3	0.940	9.81
2.0	0.609	-172.2	1.337	62.9	0.144	21.8	0.577	-48.5	0.985	9.69
2.1	0.614	-176.0	1.289	60.3	0.141	22.4	0.571	-50.5	1.028	8.60
2.2	0.616	-179.4	1.256	58.0	0.138	23.4	0.565	-51.9	1.072	7.96
2.3	0.614	177.1	1.209	55.1	0.135	24.5	0.565	-54.1	1.129	7.34
2.4	0.618	173.2	1.169	53.7	0.133	25.9	0.559	-55.6	1.177	6.91
2.5	0.622	170.1	1.119	51.4	0.130	27.7	0.558	-58.0	1.227	6.46
2.6	0.628	167.0	1.085	48.6	0.129	28.8	0.558	-60.0	1.259	6.19
2.7	0.631	164.3	1.060	46.7	0.128	31.0	0.557	-62.1	1.281	6.01
2.8	0.637	161.5	1.020	44.4	0.128	33.0	0.558	-63.7	1.299	5.73
2.9	0.638	159.1	0.988	43.0	0.130	36.0	0.552	-65.7	1.327	5.37
3.0	0.637	156.1	0.955	41.1	0.132	39.0	0.546	-67.3	1.378	4.94
4.0	0.666	131.9	0.736	25.6	0.190	58.6	0.527	-89.6	1.245	2.90
5.0	0.726	113.8	0.621	16.1	0.306	57.0	0.499	-118.5	0.952	3.07

$V_{CE} = 2\text{ V}$, $I_C = 3\text{ mA}$, $Z_o = 50\ \Omega$

Frequency (GHz)	S ₁₁		S ₂₁		S ₁₂		S ₂₂		K	MAG/MSG (dB)
	MAG.	ANG. (deg.)	MAG.	ANG. (deg.)	MAG.	ANG. (deg.)	MAG.	ANG. (deg.)		
0.1	0.879	-21.6	9.631	163.8	0.025	78.0	0.979	-9.3	0.098	25.94
0.2	0.851	-40.6	8.931	150.6	0.048	68.2	0.916	-17.9	0.166	22.71
0.3	0.768	-59.4	8.006	139.2	0.065	60.6	0.846	-24.4	0.220	20.91
0.4	0.716	-75.7	7.208	128.2	0.078	54.1	0.763	-29.7	0.295	19.66
0.5	0.664	-89.7	6.476	119.8	0.087	49.1	0.697	-33.1	0.366	18.69
0.6	0.606	-101.8	5.728	112.2	0.094	45.6	0.627	-35.8	0.462	17.85
0.7	0.573	-113.1	5.177	106.4	0.099	43.6	0.583	-37.4	0.520	17.19
0.8	0.541	-122.5	4.657	100.7	0.102	41.7	0.537	-39.0	0.604	16.58
0.9	0.526	-131.7	4.228	96.8	0.106	40.7	0.503	-40.4	0.659	16.02
1.0	0.515	-139.6	3.882	92.5	0.109	40.3	0.471	-41.3	0.721	15.52
1.1	0.502	-146.8	3.573	88.5	0.111	40.2	0.454	-42.6	0.775	15.07
1.2	0.499	-153.2	3.318	84.7	0.114	40.4	0.430	-43.4	0.830	14.65
1.3	0.495	-158.8	3.080	81.7	0.116	40.4	0.422	-44.8	0.873	14.24
1.4	0.490	-164.8	2.879	78.2	0.118	40.8	0.405	-45.6	0.932	13.86
1.5	0.489	-169.4	2.709	75.6	0.122	41.5	0.401	-46.8	0.960	13.48
1.6	0.490	-174.2	2.549	72.4	0.124	42.2	0.385	-47.5	1.011	12.48
1.7	0.496	-178.3	2.414	70.1	0.127	42.8	0.381	-48.9	1.030	11.75
1.8	0.494	177.2	2.287	67.0	0.129	43.6	0.368	-49.5	1.078	10.76
1.9	0.494	174.8	2.184	65.0	0.132	44.4	0.363	-51.2	1.109	10.18
2.0	0.503	171.3	2.070	62.4	0.136	45.4	0.353	-51.9	1.131	9.64
2.1	0.512	168.1	1.989	60.1	0.139	46.2	0.349	-54.0	1.136	9.33
2.2	0.517	165.8	1.927	58.4	0.142	47.1	0.342	-55.0	1.142	9.04
2.3	0.515	163.0	1.850	55.9	0.146	47.7	0.341	-57.2	1.162	8.59
2.4	0.522	160.3	1.785	54.6	0.150	48.3	0.336	-58.3	1.167	8.29
2.5	0.528	157.9	1.708	52.7	0.154	49.2	0.335	-60.7	1.175	7.93
2.6	0.533	155.4	1.653	50.2	0.158	49.2	0.333	-62.1	1.174	7.67
2.7	0.536	153.6	1.614	48.6	0.162	49.8	0.332	-64.2	1.166	7.50
2.8	0.541	151.2	1.555	46.7	0.168	49.9	0.331	-65.1	1.162	7.23
2.9	0.542	149.8	1.509	45.4	0.174	50.6	0.327	-67.2	1.158	6.97
3.0	0.544	147.2	1.459	43.5	0.179	51.3	0.321	-68.3	1.169	6.62
4.0	0.582	128.4	1.121	27.2	0.240	53.3	0.304	-90.6	1.120	4.59
5.0	0.661	114.1	0.939	14.2	0.322	48.6	0.271	-119.7	0.949	4.65

$V_{CE} = 2\text{ V}$, $I_C = 5\text{ mA}$, $Z_o = 50\ \Omega$

Frequency (GHz)	S ₁₁		S ₂₁		S ₁₂		S ₂₂		K	MAG/MSG (dB)
	MAG.	ANG. (deg.)	MAG.	ANG. (deg.)	MAG.	ANG. (deg.)	MAG.	ANG. (deg.)		
0.1	0.808	-27.9	14.496	159.3	0.024	73.1	0.953	-13.4	0.167	27.87
0.2	0.755	-52.7	12.763	143.0	0.044	64.7	0.848	-24.4	0.224	24.66
0.3	0.656	-74.5	10.853	130.4	0.056	57.0	0.742	-31.5	0.320	22.85
0.4	0.602	-91.9	9.282	119.7	0.066	52.3	0.643	-36.3	0.417	21.49
0.5	0.554	-106.5	8.065	111.5	0.073	49.3	0.572	-38.8	0.503	20.45
0.6	0.507	-118.7	6.963	105.0	0.078	47.8	0.505	-40.6	0.610	19.51
0.7	0.481	-129.4	6.176	100.1	0.082	47.6	0.464	-41.4	0.680	18.75
0.8	0.464	-138.6	5.482	95.1	0.087	47.3	0.422	-42.3	0.760	18.02
0.9	0.457	-146.8	4.933	91.7	0.091	47.3	0.395	-43.2	0.814	17.35
1.0	0.453	-153.8	4.498	88.2	0.095	48.0	0.367	-43.9	0.870	16.76
1.1	0.448	-160.2	4.106	84.7	0.099	48.7	0.354	-44.9	0.916	16.17
1.2	0.449	-165.6	3.806	81.5	0.104	49.5	0.334	-45.7	0.954	15.65
1.3	0.449	-170.6	3.521	78.8	0.108	49.7	0.328	-46.8	0.987	15.15
1.4	0.450	-175.5	3.282	75.7	0.112	50.5	0.313	-47.5	1.024	13.72
1.5	0.452	-179.2	3.085	73.4	0.117	51.2	0.310	-48.7	1.038	13.02
1.6	0.454	176.2	2.892	70.7	0.121	51.7	0.296	-49.3	1.073	12.12
1.7	0.462	173.1	2.736	68.7	0.127	52.1	0.293	-50.7	1.077	11.66
1.8	0.462	169.0	2.589	65.9	0.131	52.6	0.281	-51.1	1.108	10.96
1.9	0.459	166.9	2.472	64.0	0.136	53.1	0.277	-52.8	1.127	10.44
2.0	0.473	163.9	2.339	61.8	0.141	53.6	0.267	-53.4	1.132	9.99
2.1	0.481	161.4	2.244	59.7	0.146	53.8	0.265	-55.8	1.129	9.69
2.2	0.487	159.4	2.170	58.0	0.152	54.3	0.258	-56.7	1.124	9.42
2.3	0.485	157.4	2.083	55.7	0.157	54.3	0.257	-59.2	1.134	9.01
2.4	0.491	154.8	2.010	54.6	0.162	54.4	0.252	-60.2	1.135	8.71
2.5	0.498	152.9	1.925	52.9	0.168	54.7	0.251	-62.9	1.135	8.38
2.6	0.505	150.5	1.861	50.6	0.173	54.2	0.250	-64.0	1.128	8.15
2.7	0.508	149.0	1.814	49.1	0.179	54.2	0.248	-66.3	1.120	7.96
2.8	0.513	147.1	1.747	47.3	0.184	53.9	0.246	-67.0	1.119	7.67
2.9	0.514	145.7	1.698	46.0	0.192	54.1	0.243	-69.3	1.112	7.44
3.0	0.516	143.2	1.642	44.3	0.198	54.1	0.237	-70.1	1.118	7.10
4.0	0.559	126.6	1.260	28.4	0.259	52.1	0.220	-94.8	1.085	5.09
5.0	0.635	113.6	1.059	15.2	0.332	45.8	0.186	-127.0	0.963	5.04

$V_{CE} = 2\text{ V}$, $I_C = 7\text{ mA}$, $Z_o = 50\ \Omega$

Frequency (GHz)	S ₁₁		S ₂₁		S ₁₂		S ₂₂		K	MAG/MSG (dB)
	MAG.	ANG. (deg.)	MAG.	ANG. (deg.)	MAG.	ANG. (deg.)	MAG.	ANG. (deg.)		
0.1	0.743	-33.6	18.387	155.4	0.022	72.0	0.926	-16.8	0.188	29.21
0.2	0.678	-62.2	15.474	137.1	0.040	62.3	0.787	-29.0	0.286	25.92
0.3	0.577	-85.9	12.589	124.5	0.050	55.9	0.664	-35.9	0.407	23.99
0.4	0.528	-103.7	10.452	114.1	0.058	52.7	0.561	-39.9	0.518	22.54
0.5	0.490	-118.3	8.879	106.7	0.064	51.1	0.493	-41.4	0.610	21.39
0.6	0.455	-130.1	7.585	100.8	0.070	51.0	0.432	-42.7	0.714	20.37
0.7	0.440	-140.4	6.677	96.3	0.074	51.5	0.395	-42.9	0.780	19.53
0.8	0.427	-148.7	5.901	91.9	0.079	52.1	0.359	-43.5	0.856	18.72
0.9	0.427	-156.0	5.294	89.0	0.084	52.4	0.335	-44.2	0.901	17.98
1.0	0.429	-162.4	4.804	85.7	0.090	53.4	0.311	-44.7	0.941	17.28
1.1	0.425	-168.2	4.380	82.7	0.095	54.3	0.300	-45.7	0.980	16.65
1.2	0.428	-173.3	4.042	79.7	0.100	55.1	0.283	-46.4	1.010	15.44
1.3	0.431	-177.1	3.739	77.2	0.106	55.3	0.278	-47.6	1.030	14.43
1.4	0.432	178.6	3.477	74.4	0.111	55.9	0.264	-48.3	1.060	13.47
1.5	0.436	174.6	3.266	72.3	0.117	56.4	0.263	-49.5	1.064	12.92
1.6	0.439	170.7	3.063	69.7	0.122	56.7	0.250	-50.0	1.088	12.17
1.7	0.447	168.2	2.890	67.8	0.128	56.8	0.247	-51.4	1.090	11.70
1.8	0.448	164.1	2.740	65.2	0.134	57.1	0.235	-51.9	1.109	11.10
1.9	0.448	162.2	2.616	63.6	0.139	57.3	0.233	-53.7	1.118	10.65
2.0	0.461	160.1	2.471	61.3	0.145	57.5	0.223	-54.4	1.121	10.19
2.1	0.468	157.9	2.370	59.4	0.151	57.4	0.221	-57.1	1.118	9.87
2.2	0.473	156.2	2.291	57.9	0.157	57.5	0.215	-57.9	1.113	9.60
2.3	0.471	153.9	2.200	55.6	0.163	57.3	0.213	-60.7	1.118	9.20
2.4	0.479	151.6	2.121	54.5	0.169	57.2	0.209	-61.7	1.115	8.92
2.5	0.486	149.8	2.032	52.9	0.175	57.1	0.208	-64.7	1.115	8.59
2.6	0.492	147.9	1.960	50.7	0.181	56.5	0.206	-65.5	1.109	8.34
2.7	0.493	146.3	1.911	49.2	0.187	56.2	0.204	-68.3	1.105	8.13
2.8	0.501	144.7	1.844	47.5	0.193	55.6	0.203	-68.6	1.097	7.91
2.9	0.501	143.5	1.790	46.2	0.201	55.5	0.200	-71.5	1.092	7.65
3.0	0.504	141.4	1.732	44.6	0.207	55.4	0.195	-71.9	1.096	7.34
4.0	0.544	125.5	1.326	29.0	0.269	51.7	0.179	-99.3	1.078	5.23
5.0	0.623	113.4	1.120	15.7	0.338	44.6	0.148	-135.7	0.969	5.20

$V_{CE} = 2\text{ V}$, $I_C = 10\text{ mA}$, $Z_0 = 50\ \Omega$

Frequency (GHz)	S ₁₁		S ₂₁		S ₁₂		S ₂₂		K	MAG/MSG (dB)
	MAG.	ANG. (deg.)	MAG.	ANG. (deg.)	MAG.	ANG. (deg.)	MAG.	ANG. (deg.)		
0.1	0.673	-42.6	22.814	151.0	0.021	68.7	0.888	-20.8	0.228	30.27
0.2	0.595	-74.5	18.086	130.9	0.035	59.1	0.713	-33.7	0.368	27.08
0.3	0.501	-99.2	14.085	118.6	0.044	55.8	0.581	-39.6	0.511	25.03
0.4	0.464	-116.5	11.405	108.9	0.051	54.9	0.482	-42.5	0.631	23.50
0.5	0.440	-130.8	9.500	102.2	0.057	54.5	0.421	-43.0	0.720	22.19
0.6	0.417	-142.0	8.060	97.1	0.063	55.2	0.367	-43.5	0.815	21.06
0.7	0.408	-150.9	7.034	93.2	0.069	56.3	0.336	-43.1	0.874	20.10
0.8	0.402	-158.4	6.207	89.2	0.074	57.3	0.305	-43.5	0.936	19.23
0.9	0.406	-164.9	5.551	86.6	0.080	57.8	0.285	-44.1	0.971	18.41
1.0	0.411	-170.7	5.027	83.7	0.086	58.7	0.264	-44.5	1.000	17.65
1.1	0.410	-175.5	4.571	80.8	0.093	59.5	0.255	-45.4	1.027	15.93
1.2	0.415	-179.6	4.220	78.0	0.099	60.1	0.240	-46.3	1.044	15.02
1.3	0.419	176.7	3.900	75.8	0.105	60.1	0.237	-47.5	1.058	14.23
1.4	0.420	172.7	3.622	73.2	0.111	60.4	0.225	-48.3	1.080	13.41
1.5	0.426	169.5	3.400	71.3	0.118	60.7	0.224	-49.5	1.078	12.90
1.6	0.431	166.0	3.184	68.7	0.124	60.7	0.212	-50.1	1.095	12.22
1.7	0.438	163.9	3.005	67.1	0.130	60.5	0.211	-51.8	1.094	11.77
1.8	0.442	160.2	2.847	64.7	0.137	60.7	0.199	-52.2	1.104	11.23
1.9	0.442	158.5	2.718	62.9	0.143	60.6	0.197	-54.2	1.109	10.79
2.0	0.453	156.2	2.571	60.7	0.149	60.5	0.188	-54.9	1.110	10.34
2.1	0.460	154.6	2.460	59.0	0.156	60.2	0.186	-58.0	1.107	10.00
2.2	0.466	153.0	2.379	57.5	0.162	60.0	0.180	-58.8	1.099	9.75
2.3	0.465	151.1	2.285	55.3	0.169	59.7	0.179	-61.9	1.101	9.38
2.4	0.472	148.9	2.202	54.3	0.175	59.3	0.175	-62.8	1.100	9.09
2.5	0.479	147.5	2.106	52.7	0.181	59.0	0.174	-66.4	1.099	8.74
2.6	0.486	145.7	2.035	50.6	0.187	58.3	0.172	-67.1	1.092	8.51
2.7	0.487	144.2	1.983	49.2	0.194	57.7	0.170	-70.3	1.087	8.31
2.8	0.493	142.2	1.917	47.5	0.200	57.0	0.169	-70.5	1.080	8.09
2.9	0.495	141.4	1.857	46.2	0.208	56.8	0.166	-73.5	1.077	7.82
3.0	0.496	139.3	1.796	44.7	0.214	56.5	0.161	-74.0	1.081	7.50
4.0	0.538	124.6	1.375	29.5	0.277	51.5	0.148	-104.5	1.065	5.41
5.0	0.617	112.9	1.161	16.3	0.343	43.7	0.122	-146.6	0.969	5.29

$V_{CE} = 2\text{ V}$, $I_C = 20\text{ mA}$, $Z_O = 50\ \Omega$

Frequency (GHz)	S ₁₁		S ₂₁		S ₁₂		S ₂₂		K	MAG/MSG (dB)
	MAG.	ANG. (deg.)	MAG.	ANG. (deg.)	MAG.	ANG. (deg.)	MAG.	ANG. (deg.)		
0.1	0.507	-63.4	30.369	140.8	0.018	64.5	0.781	-28.3	0.359	32.21
0.2	0.460	-102.7	21.184	119.5	0.028	60.2	0.563	-39.6	0.546	28.76
0.3	0.415	-127.3	15.437	108.9	0.035	60.0	0.442	-41.9	0.718	26.46
0.4	0.406	-142.3	12.042	101.1	0.042	60.9	0.365	-42.1	0.825	24.57
0.5	0.403	-152.8	9.845	95.7	0.049	61.9	0.323	-40.4	0.893	23.05
0.6	0.395	-161.7	8.268	91.5	0.055	63.6	0.284	-39.7	0.963	21.74
0.7	0.396	-168.7	7.185	88.2	0.062	64.9	0.265	-38.5	0.997	20.63
0.8	0.398	-174.3	6.297	84.8	0.069	65.5	0.242	-38.4	1.032	18.50
0.9	0.406	-178.4	5.617	82.6	0.075	65.8	0.229	-39.1	1.052	17.32
1.0	0.414	177.3	5.068	80.2	0.083	66.4	0.213	-39.3	1.064	16.32
1.1	0.415	173.2	4.608	77.6	0.090	66.7	0.208	-40.6	1.078	15.39
1.2	0.421	170.1	4.235	75.2	0.097	66.8	0.197	-41.6	1.086	14.60
1.3	0.424	167.6	3.920	73.2	0.104	66.6	0.195	-43.3	1.091	13.92
1.4	0.432	164.1	3.637	70.8	0.111	66.4	0.186	-44.1	1.100	13.24
1.5	0.435	161.9	3.414	69.1	0.118	66.3	0.186	-45.8	1.095	12.72
1.6	0.441	159.1	3.196	66.7	0.125	66.1	0.176	-46.5	1.103	12.12
1.7	0.451	157.2	3.014	65.1	0.132	65.6	0.176	-48.5	1.096	11.69
1.8	0.453	154.4	2.857	62.9	0.139	65.3	0.165	-49.0	1.101	11.18
1.9	0.450	152.6	2.726	61.3	0.146	64.9	0.164	-51.5	1.109	10.71
2.0	0.463	151.2	2.575	59.2	0.153	64.6	0.156	-52.3	1.105	10.29
2.1	0.471	149.7	2.466	57.5	0.160	63.9	0.154	-55.9	1.098	9.98
2.2	0.475	148.4	2.380	56.1	0.166	63.6	0.148	-56.9	1.091	9.71
2.3	0.476	146.8	2.290	54.0	0.174	63.0	0.147	-60.6	1.090	9.38
2.4	0.482	144.7	2.206	53.1	0.180	62.3	0.144	-61.6	1.088	9.08
2.5	0.489	143.8	2.112	51.5	0.186	61.8	0.144	-65.7	1.086	8.75
2.6	0.495	141.9	2.036	49.4	0.193	60.8	0.142	-66.5	1.079	8.52
2.7	0.496	140.7	1.987	48.1	0.200	60.3	0.141	-70.1	1.073	8.32
2.8	0.502	139.0	1.921	46.5	0.207	59.2	0.140	-70.2	1.066	8.11
2.9	0.504	138.2	1.863	45.2	0.215	58.9	0.137	-74.0	1.061	7.87
3.0	0.506	136.3	1.800	43.8	0.221	58.3	0.133	-74.3	1.065	7.55
4.0	0.544	122.4	1.374	28.8	0.285	52.2	0.124	-109.4	1.056	5.39
5.0	0.624	111.5	1.159	15.9	0.350	43.7	0.107	-158.0	0.965	5.20

$V_{CE} = 3\text{ V}$, $I_C = 1\text{ mA}$, $Z_o = 50\ \Omega$

Frequency (GHz)	S ₁₁		S ₂₁		S ₁₂		S ₂₂		K	MAG/MSG (dB)
	MAG.	ANG. (deg.)	MAG.	ANG. (deg.)	MAG.	ANG. (deg.)	MAG.	ANG. (deg.)		
0.1	0.965	-12.4	3.529	169.3	0.023	83.9	1.004	-3.7	0.050	21.79
0.2	0.960	-24.3	3.417	161.8	0.047	75.9	0.986	-7.9	0.091	18.57
0.3	0.914	-36.9	3.274	153.2	0.068	69.3	0.969	-11.4	0.120	16.83
0.4	0.898	-48.9	3.162	144.1	0.087	62.7	0.936	-15.3	0.167	15.60
0.5	0.864	-59.9	3.056	136.4	0.104	56.5	0.911	-18.4	0.211	14.68
0.6	0.818	-70.4	2.869	128.4	0.117	50.9	0.866	-21.4	0.276	13.91
0.7	0.782	-80.9	2.717	122.0	0.127	46.6	0.839	-23.7	0.305	13.30
0.8	0.742	-90.1	2.557	115.2	0.134	42.1	0.800	-25.9	0.374	12.81
0.9	0.713	-99.1	2.398	110.0	0.139	38.3	0.772	-27.9	0.414	12.35
1.0	0.687	-107.7	2.262	104.6	0.143	35.3	0.739	-29.7	0.468	11.99
1.1	0.664	-116.1	2.128	99.3	0.145	32.5	0.723	-31.7	0.506	11.65
1.2	0.649	-123.8	2.020	94.4	0.146	30.3	0.698	-33.0	0.559	11.40
1.3	0.638	-130.7	1.898	90.1	0.147	28.0	0.689	-34.8	0.593	11.11
1.4	0.621	-137.6	1.800	85.6	0.146	26.2	0.671	-36.1	0.663	10.90
1.5	0.610	-143.6	1.708	82.0	0.146	25.1	0.666	-37.8	0.700	10.69
1.6	0.603	-149.8	1.625	77.9	0.144	23.9	0.649	-39.1	0.769	10.54
1.7	0.603	-155.2	1.551	74.7	0.141	23.1	0.643	-40.8	0.806	10.41
1.8	0.592	-160.8	1.476	70.7	0.139	22.9	0.630	-41.9	0.896	10.27
1.9	0.590	-164.7	1.413	68.2	0.135	22.9	0.623	-43.5	0.957	10.18
2.0	0.598	-169.9	1.347	64.8	0.133	23.6	0.612	-44.7	1.014	9.34
2.1	0.601	-173.8	1.301	62.1	0.130	24.3	0.606	-46.5	1.061	8.49
2.2	0.605	-177.2	1.267	60.1	0.127	25.5	0.601	-47.9	1.103	8.04
2.3	0.603	179.0	1.217	57.3	0.125	26.8	0.601	-49.9	1.160	7.47
2.4	0.606	175.0	1.176	55.6	0.122	28.1	0.595	-51.4	1.214	7.03
2.5	0.608	171.8	1.128	53.5	0.120	30.2	0.594	-53.6	1.272	6.58
2.6	0.615	168.6	1.095	50.4	0.119	31.5	0.595	-55.6	1.296	6.38
2.7	0.616	165.7	1.068	48.7	0.118	33.8	0.593	-57.7	1.330	6.12
2.8	0.621	162.8	1.028	46.4	0.119	36.0	0.594	-59.0	1.346	5.86
2.9	0.621	160.4	0.996	44.9	0.121	39.3	0.588	-60.8	1.374	5.51
3.0	0.623	157.2	0.964	43.0	0.123	42.5	0.581	-62.5	1.416	5.12
4.0	0.651	132.2	0.742	27.3	0.182	62.9	0.562	-83.4	1.248	3.09
5.0	0.712	114.1	0.624	18.0	0.300	61.2	0.528	-110.3	0.947	3.18

$V_{CE} = 3\text{ V}$, $I_C = 3\text{ mA}$, $Z_o = 50\ \Omega$

Frequency (GHz)	S ₁₁		S ₂₁		S ₁₂		S ₂₂		K	MAG/MSG (dB)
	MAG.	ANG. (deg.)	MAG.	ANG. (deg.)	MAG.	ANG. (deg.)	MAG.	ANG. (deg.)		
0.1	0.894	-20.7	9.603	164.4	0.022	76.8	0.982	-8.3	0.120	26.40
0.2	0.859	-38.5	8.941	151.7	0.043	69.8	0.926	-16.1	0.157	23.17
0.3	0.773	-56.4	8.072	140.5	0.059	61.4	0.862	-22.0	0.227	21.37
0.4	0.721	-71.8	7.295	129.7	0.071	55.5	0.785	-26.7	0.301	20.11
0.5	0.665	-85.9	6.575	121.2	0.080	50.5	0.725	-29.8	0.370	19.13
0.6	0.606	-97.5	5.860	113.8	0.087	47.1	0.658	-32.3	0.466	18.29
0.7	0.567	-108.5	5.295	108.0	0.092	44.9	0.616	-33.8	0.528	17.62
0.8	0.533	-118.4	4.779	102.3	0.095	43.2	0.570	-35.1	0.612	17.03
0.9	0.514	-127.4	4.348	98.2	0.098	42.2	0.539	-36.2	0.670	16.46
1.0	0.502	-135.6	3.991	94.1	0.101	42.0	0.507	-37.0	0.733	15.98
1.1	0.487	-143.1	3.679	90.0	0.103	41.8	0.490	-38.1	0.789	15.52
1.2	0.479	-149.9	3.426	86.2	0.106	42.1	0.468	-39.0	0.846	15.09
1.3	0.479	-155.6	3.181	83.1	0.108	42.0	0.459	-40.2	0.886	14.68
1.4	0.471	-161.4	2.973	79.6	0.110	42.5	0.443	-40.7	0.948	14.31
1.5	0.468	-166.3	2.800	77.0	0.113	43.2	0.439	-42.0	0.978	13.94
1.6	0.467	-171.6	2.633	73.8	0.116	43.8	0.424	-42.6	1.030	12.51
1.7	0.474	-175.6	2.499	71.5	0.118	44.5	0.420	-44.0	1.047	11.93
1.8	0.472	179.7	2.369	68.5	0.121	45.4	0.408	-44.4	1.096	11.04
1.9	0.470	176.7	2.259	66.3	0.123	46.3	0.403	-45.9	1.131	10.43
2.0	0.480	173.2	2.141	63.8	0.127	47.4	0.393	-46.6	1.154	9.90
2.1	0.488	169.8	2.057	61.6	0.130	48.1	0.389	-48.5	1.158	9.59
2.2	0.492	167.5	1.994	59.8	0.133	49.2	0.383	-49.4	1.167	9.29
2.3	0.492	164.7	1.910	57.4	0.137	50.0	0.381	-51.3	1.186	8.84
2.4	0.498	161.9	1.846	56.1	0.140	50.7	0.377	-52.4	1.190	8.56
2.5	0.503	159.2	1.766	54.2	0.144	51.5	0.375	-54.6	1.199	8.18
2.6	0.509	156.8	1.708	51.7	0.148	51.6	0.374	-55.9	1.196	7.94
2.7	0.511	155.0	1.667	50.1	0.152	52.2	0.372	-57.9	1.190	7.75
2.8	0.518	152.6	1.607	48.1	0.158	52.3	0.372	-58.8	1.178	7.53
2.9	0.520	150.8	1.557	46.8	0.164	53.2	0.367	-60.6	1.176	7.24
3.0	0.521	148.4	1.507	44.9	0.169	54.0	0.362	-61.6	1.186	6.89
4.0	0.563	129.0	1.158	28.7	0.229	56.4	0.341	-81.6	1.117	4.96
5.0	0.642	114.8	0.969	15.5	0.312	52.2	0.299	-107.3	0.941	4.92

$V_{CE} = 3\text{ V}$, $I_C = 5\text{ mA}$, $Z_o = 50\ \Omega$

Frequency (GHz)	S ₁₁		S ₂₁		S ₁₂		S ₂₂		K	MAG/MSG (dB)
	MAG.	ANG. (deg.)	MAG.	ANG. (deg.)	MAG.	ANG. (deg.)	MAG.	ANG. (deg.)		
0.1	0.824	-27.1	14.507	160.1	0.022	76.6	0.959	-11.9	0.120	28.25
0.2	0.764	-49.4	12.879	144.1	0.039	66.7	0.863	-21.9	0.221	25.14
0.3	0.660	-69.9	11.023	131.9	0.051	58.1	0.767	-28.3	0.330	23.31
0.4	0.601	-87.5	9.511	121.2	0.060	53.9	0.672	-32.6	0.420	21.97
0.5	0.550	-101.5	8.274	113.0	0.067	50.9	0.606	-34.6	0.509	20.91
0.6	0.500	-113.7	7.187	106.4	0.072	49.2	0.540	-36.3	0.614	19.97
0.7	0.468	-124.8	6.380	101.5	0.077	48.9	0.501	-36.8	0.687	19.21
0.8	0.445	-133.8	5.686	96.6	0.080	48.5	0.461	-37.5	0.770	18.49
0.9	0.439	-142.3	5.115	93.0	0.084	48.9	0.434	-38.2	0.823	17.82
1.0	0.430	-149.8	4.664	89.5	0.089	49.4	0.406	-38.7	0.882	17.21
1.1	0.426	-156.3	4.259	86.0	0.093	50.2	0.394	-39.5	0.927	16.63
1.2	0.425	-162.5	3.952	82.8	0.097	50.9	0.375	-40.1	0.969	16.12
1.3	0.422	-167.2	3.660	80.1	0.101	51.3	0.368	-41.2	1.002	15.30
1.4	0.423	-172.4	3.409	77.1	0.105	51.9	0.354	-41.6	1.041	13.89
1.5	0.425	-177.0	3.200	74.8	0.109	52.8	0.351	-42.7	1.056	13.22
1.6	0.425	178.5	3.009	72.0	0.114	53.3	0.338	-43.2	1.090	12.40
1.7	0.433	175.3	2.842	69.9	0.118	53.6	0.335	-44.4	1.096	11.92
1.8	0.435	171.0	2.692	67.2	0.123	54.3	0.324	-44.8	1.123	11.28
1.9	0.433	168.4	2.567	65.4	0.127	54.9	0.320	-46.3	1.140	10.77
2.0	0.446	165.8	2.429	63.0	0.132	55.4	0.310	-46.9	1.148	10.30
2.1	0.453	163.1	2.337	61.0	0.137	55.7	0.307	-48.9	1.145	10.01
2.2	0.457	161.2	2.256	59.4	0.142	56.0	0.301	-49.7	1.147	9.68
2.3	0.458	158.7	2.166	57.2	0.147	56.3	0.299	-51.8	1.151	9.31
2.4	0.463	156.2	2.087	56.0	0.152	56.4	0.295	-52.7	1.154	9.00
2.5	0.471	154.1	2.001	54.3	0.157	56.8	0.293	-55.1	1.153	8.68
2.6	0.477	151.7	1.935	52.0	0.162	56.3	0.292	-56.1	1.145	8.44
2.7	0.479	150.3	1.883	50.5	0.168	56.4	0.290	-58.2	1.138	8.23
2.8	0.486	148.1	1.818	48.7	0.174	56.0	0.289	-58.9	1.131	8.00
2.9	0.487	146.8	1.760	47.3	0.181	56.3	0.285	-61.0	1.127	7.71
3.0	0.489	144.5	1.705	45.7	0.187	56.4	0.280	-61.7	1.130	7.41
4.0	0.532	127.5	1.311	29.9	0.247	54.9	0.257	-82.7	1.089	5.42
5.0	0.613	114.5	1.099	16.6	0.321	49.2	0.211	-109.6	0.960	5.35

$V_{CE} = 3\text{ V}$, $I_C = 7\text{ mA}$, $Z_o = 50\ \Omega$

Frequency (GHz)	S ₁₁		S ₂₁		S ₁₂		S ₂₂		K	MAG/MSG (dB)
	MAG.	ANG. (deg.)	MAG.	ANG. (deg.)	MAG.	ANG. (deg.)	MAG.	ANG. (deg.)		
0.1	0.765	-31.9	18.341	156.5	0.020	74.5	0.938	-15.0	0.155	29.53
0.2	0.692	-57.8	15.639	138.6	0.036	63.0	0.809	-25.9	0.295	26.34
0.3	0.583	-80.7	12.853	126.1	0.047	57.6	0.694	-32.0	0.404	24.41
0.4	0.528	-97.9	10.737	115.7	0.054	54.1	0.596	-35.6	0.518	22.98
0.5	0.481	-112.6	9.162	108.2	0.060	52.5	0.531	-36.8	0.614	21.85
0.6	0.438	-124.6	7.855	102.2	0.065	52.1	0.471	-37.6	0.721	20.82
0.7	0.418	-134.9	6.923	97.8	0.069	52.7	0.436	-37.6	0.790	19.99
0.8	0.403	-143.8	6.122	93.3	0.074	53.2	0.400	-38.0	0.865	19.18
0.9	0.402	-151.7	5.499	90.2	0.079	53.8	0.377	-38.4	0.909	18.44
1.0	0.401	-158.3	4.995	87.0	0.084	54.5	0.353	-38.7	0.956	17.75
1.1	0.398	-164.5	4.560	83.9	0.089	55.5	0.343	-39.5	0.990	17.11
1.2	0.399	-169.8	4.219	80.9	0.094	56.3	0.326	-40.0	1.020	15.66
1.3	0.401	-174.0	3.896	78.5	0.099	56.6	0.321	-41.1	1.044	14.68
1.4	0.401	-178.7	3.625	75.7	0.104	57.1	0.309	-41.5	1.073	13.78
1.5	0.404	177.3	3.404	73.6	0.109	57.7	0.307	-42.6	1.079	13.21
1.6	0.410	173.3	3.189	70.9	0.115	58.0	0.295	-43.0	1.100	12.51
1.7	0.417	170.3	3.015	69.1	0.120	58.3	0.292	-44.3	1.104	12.04
1.8	0.418	166.3	2.853	66.6	0.125	58.5	0.281	-44.6	1.124	11.43
1.9	0.420	164.1	2.725	64.8	0.131	58.8	0.278	-46.2	1.130	11.00
2.0	0.431	161.6	2.578	62.5	0.136	59.1	0.269	-46.6	1.135	10.53
2.1	0.436	159.4	2.468	60.7	0.142	59.1	0.265	-49.0	1.135	10.17
2.2	0.442	157.6	2.386	59.2	0.147	59.3	0.260	-49.6	1.129	9.90
2.3	0.444	155.3	2.292	57.0	0.153	59.2	0.258	-51.9	1.129	9.56
2.4	0.451	153.3	2.212	55.9	0.159	59.0	0.254	-52.8	1.127	9.28
2.5	0.455	151.3	2.115	54.3	0.164	59.0	0.252	-55.3	1.134	8.88
2.6	0.463	149.1	2.044	51.9	0.170	58.4	0.251	-56.3	1.121	8.68
2.7	0.465	147.6	1.995	50.5	0.176	58.2	0.248	-58.5	1.114	8.49
2.8	0.471	145.9	1.924	48.9	0.182	57.6	0.248	-59.0	1.108	8.24
2.9	0.471	144.5	1.863	47.5	0.189	57.7	0.243	-61.2	1.107	7.94
3.0	0.474	142.3	1.800	45.9	0.196	57.6	0.239	-61.8	1.109	7.62
4.0	0.518	126.3	1.383	30.5	0.257	54.4	0.216	-84.2	1.078	5.62
5.0	0.601	114.3	1.164	17.2	0.326	47.8	0.168	-113.0	0.962	5.52

$V_{CE} = 3\text{ V}$, $I_C = 10\text{ mA}$, $Z_O = 50\ \Omega$

Frequency (GHz)	S ₁₁		S ₂₁		S ₁₂		S ₂₂		K	MAG/MSG (dB)
	MAG.	ANG. (deg.)	MAG.	ANG. (deg.)	MAG.	ANG. (deg.)	MAG.	ANG. (deg.)		
0.1	0.691	-38.8	22.865	152.1	0.019	67.9	0.903	-18.4	0.249	30.84
0.2	0.605	-68.9	18.397	132.6	0.033	61.5	0.740	-30.0	0.364	27.52
0.3	0.499	-93.0	14.480	120.2	0.041	56.9	0.616	-35.2	0.512	25.49
0.4	0.456	-110.4	11.777	110.5	0.048	56.0	0.520	-37.5	0.629	23.91
0.5	0.423	-124.1	9.859	103.7	0.053	55.5	0.462	-37.6	0.728	22.69
0.6	0.398	-135.9	8.390	98.5	0.059	56.3	0.409	-37.8	0.816	21.52
0.7	0.383	-145.5	7.334	94.4	0.064	57.7	0.380	-37.3	0.879	20.57
0.8	0.373	-153.4	6.467	90.4	0.070	58.1	0.349	-37.3	0.944	19.69
0.9	0.378	-161.0	5.794	87.8	0.075	58.9	0.330	-37.6	0.977	18.88
1.0	0.379	-166.8	5.252	84.8	0.081	59.7	0.309	-37.8	1.010	17.52
1.1	0.377	-172.1	4.779	81.8	0.087	60.6	0.301	-38.5	1.037	16.24
1.2	0.382	-176.9	4.403	79.4	0.092	61.2	0.286	-39.0	1.058	15.31
1.3	0.385	179.5	4.068	77.0	0.098	61.3	0.283	-40.2	1.073	14.53
1.4	0.390	175.1	3.791	74.4	0.104	61.7	0.271	-40.6	1.089	13.80
1.5	0.392	171.7	3.555	72.5	0.110	61.9	0.270	-41.9	1.092	13.24
1.6	0.397	168.0	3.331	70.0	0.116	62.0	0.259	-42.2	1.107	12.59
1.7	0.406	165.9	3.147	68.3	0.122	62.0	0.257	-43.7	1.105	12.14
1.8	0.410	161.9	2.977	65.9	0.128	62.0	0.247	-43.8	1.116	11.59
1.9	0.408	159.8	2.843	64.1	0.134	62.0	0.244	-45.6	1.121	11.14
2.0	0.421	157.9	2.687	62.1	0.140	62.0	0.235	-46.0	1.124	10.69
2.1	0.427	155.8	2.573	60.3	0.146	61.8	0.232	-48.5	1.123	10.33
2.2	0.431	154.4	2.485	58.8	0.152	61.7	0.226	-49.1	1.115	10.06
2.3	0.432	152.5	2.389	56.7	0.158	61.4	0.225	-51.6	1.117	9.71
2.4	0.439	150.2	2.305	55.6	0.164	61.1	0.221	-52.5	1.112	9.44
2.5	0.445	148.6	2.203	54.1	0.170	60.9	0.219	-55.3	1.116	9.05
2.6	0.453	146.6	2.127	52.0	0.176	60.1	0.218	-56.2	1.105	8.84
2.7	0.455	145.5	2.074	50.6	0.182	59.8	0.215	-58.3	1.100	8.63
2.8	0.461	143.7	2.001	48.8	0.189	59.0	0.214	-58.9	1.093	8.40
2.9	0.465	142.3	1.940	47.6	0.196	58.9	0.210	-61.2	1.086	8.16
3.0	0.466	140.4	1.876	46.1	0.202	58.5	0.206	-61.7	1.090	7.84
4.0	0.511	125.7	1.438	30.9	0.264	54.3	0.182	-86.2	1.067	5.79
5.0	0.590	113.8	1.210	17.7	0.331	47.0	0.134	-117.6	0.970	5.63

$V_{CE} = 3\text{ V}$, $I_C = 20\text{ mA}$, $Z_O = 50\ \Omega$

Frequency (GHz)	S ₁₁		S ₂₁		S ₁₂		S ₂₂		K	MAG/MSG (dB)
	MAG.	ANG. (deg.)	MAG.	ANG. (deg.)	MAG.	ANG. (deg.)	MAG.	ANG. (deg.)		
0.1	0.536	-56.2	30.907	142.5	0.016	63.0	0.811	-24.7	0.371	32.98
0.2	0.456	-94.3	21.968	121.5	0.026	61.4	0.606	-34.6	0.538	29.19
0.3	0.394	-119.1	16.166	110.7	0.033	59.7	0.488	-36.5	0.716	26.97
0.4	0.377	-134.5	12.668	102.6	0.039	62.0	0.413	-36.1	0.827	25.12
0.5	0.368	-146.2	10.401	97.0	0.046	62.9	0.372	-34.4	0.895	23.59
0.6	0.357	-156.2	8.738	92.7	0.052	64.2	0.335	-33.5	0.966	22.27
0.7	0.357	-163.5	7.603	89.5	0.058	65.6	0.316	-32.3	1.000	21.18
0.8	0.355	-169.9	6.673	86.0	0.064	66.2	0.294	-32.1	1.042	18.91
0.9	0.365	-175.1	5.950	83.9	0.070	66.5	0.281	-32.4	1.060	17.78
1.0	0.371	-179.8	5.376	81.4	0.077	67.0	0.265	-32.4	1.075	16.76
1.1	0.372	176.1	4.885	79.0	0.084	67.7	0.260	-33.4	1.086	15.85
1.2	0.378	172.6	4.484	76.6	0.090	67.8	0.249	-34.0	1.100	15.02
1.3	0.383	170.1	4.150	74.6	0.097	67.6	0.248	-35.6	1.104	14.36
1.4	0.390	166.3	3.861	72.1	0.103	67.5	0.238	-36.0	1.110	13.71
1.5	0.394	163.7	3.620	70.5	0.110	67.5	0.239	-37.6	1.104	13.19
1.6	0.401	160.8	3.395	68.1	0.117	67.2	0.229	-37.9	1.110	12.61
1.7	0.408	159.0	3.202	66.5	0.124	66.9	0.228	-39.8	1.107	12.15
1.8	0.414	155.5	3.032	64.3	0.130	66.6	0.219	-39.8	1.110	11.65
1.9	0.407	154.2	2.891	62.7	0.136	66.2	0.216	-41.9	1.121	11.15
2.0	0.422	152.6	2.734	60.7	0.143	66.1	0.208	-42.3	1.118	10.73
2.1	0.430	151.0	2.617	59.0	0.150	65.5	0.206	-45.2	1.109	10.42
2.2	0.435	149.6	2.530	57.5	0.156	65.1	0.200	-45.8	1.102	10.16
2.3	0.435	148.1	2.428	55.5	0.163	64.7	0.198	-48.5	1.102	9.79
2.4	0.441	145.9	2.341	54.5	0.169	64.0	0.196	-49.5	1.099	9.51
2.5	0.449	144.5	2.240	53.1	0.175	63.7	0.193	-52.6	1.097	9.17
2.6	0.457	142.9	2.161	51.0	0.181	62.7	0.192	-53.4	1.088	8.96
2.7	0.457	141.8	2.110	49.6	0.188	62.1	0.190	-56.1	1.082	8.75
2.8	0.465	140.1	2.032	48.0	0.194	61.2	0.189	-56.3	1.075	8.52
2.9	0.467	139.2	1.972	46.9	0.202	61.0	0.185	-59.0	1.070	8.28
3.0	0.469	137.3	1.907	45.3	0.209	60.4	0.181	-59.3	1.072	7.96
4.0	0.512	123.7	1.456	30.5	0.270	55.0	0.158	-86.2	1.056	5.86
5.0	0.594	112.7	1.224	17.5	0.336	47.0	0.110	-120.9	0.963	5.61

PACKAGE DIMENSIONS

3-PIN LEAD-LESS MINIMOLD (UNIT: mm)

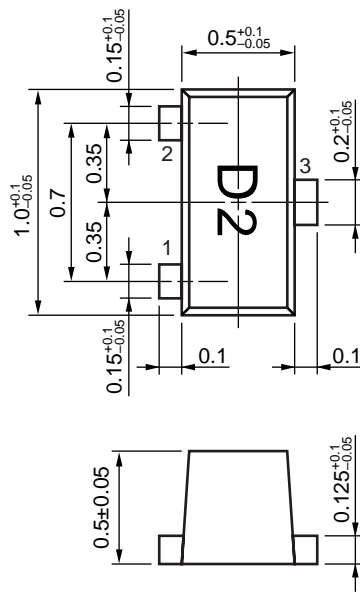

(Bottom View)

PIN CONNECTIONS

- 1. Emitter
- 2. Base
- 3. Collector

[MEMO]

[MEMO]

- **The information in this document is current as of June, 2001. The information is subject to change without notice. For actual design-in, refer to the latest publications of NEC's data sheets or data books, etc., for the most up-to-date specifications of NEC semiconductor products. Not all products and/or types are available in every country. Please check with an NEC sales representative for availability and additional information.**
 - No part of this document may be copied or reproduced in any form or by any means without prior written consent of NEC. NEC assumes no responsibility for any errors that may appear in this document.
 - NEC does not assume any liability for infringement of patents, copyrights or other intellectual property rights of third parties by or arising from the use of NEC semiconductor products listed in this document or any other liability arising from the use of such products. No license, express, implied or otherwise, is granted under any patents, copyrights or other intellectual property rights of NEC or others.
 - Descriptions of circuits, software and other related information in this document are provided for illustrative purposes in semiconductor product operation and application examples. The incorporation of these circuits, software and information in the design of customer's equipment shall be done under the full responsibility of customer. NEC assumes no responsibility for any losses incurred by customers or third parties arising from the use of these circuits, software and information.
 - While NEC endeavours to enhance the quality, reliability and safety of NEC semiconductor products, customers agree and acknowledge that the possibility of defects thereof cannot be eliminated entirely. To minimize risks of damage to property or injury (including death) to persons arising from defects in NEC semiconductor products, customers must incorporate sufficient safety measures in their design, such as redundancy, fire-containment, and anti-failure features.
 - NEC semiconductor products are classified into the following three quality grades:
"Standard", "Special" and "Specific". The "Specific" quality grade applies only to semiconductor products developed based on a customer-designated "quality assurance program" for a specific application. The recommended applications of a semiconductor product depend on its quality grade, as indicated below. Customers must check the quality grade of each semiconductor product before using it in a particular application.
"Standard": Computers, office equipment, communications equipment, test and measurement equipment, audio and visual equipment, home electronic appliances, machine tools, personal electronic equipment and industrial robots
"Special": Transportation equipment (automobiles, trains, ships, etc.), traffic control systems, anti-disaster systems, anti-crime systems, safety equipment and medical equipment (not specifically designed for life support)
"Specific": Aircraft, aerospace equipment, submersible repeaters, nuclear reactor control systems, life support systems and medical equipment for life support, etc.
- The quality grade of NEC semiconductor products is "Standard" unless otherwise expressly specified in NEC's data sheets or data books, etc. If customers wish to use NEC semiconductor products in applications not intended by NEC, they must contact an NEC sales representative in advance to determine NEC's willingness to support a given application.
- (Note)
- (1) "NEC" as used in this statement means NEC Corporation and also includes its majority-owned subsidiaries.
 - (2) "NEC semiconductor products" means any semiconductor product developed or manufactured by or for NEC (as defined above).