

Notice: You cannot copy or search for text in this PDF file, because this PDF file is converted from the scanned image of printed materials.

P1 98.2

SWITCHING
N-CHANNEL POWER MOS FET
INDUSTRIAL USE

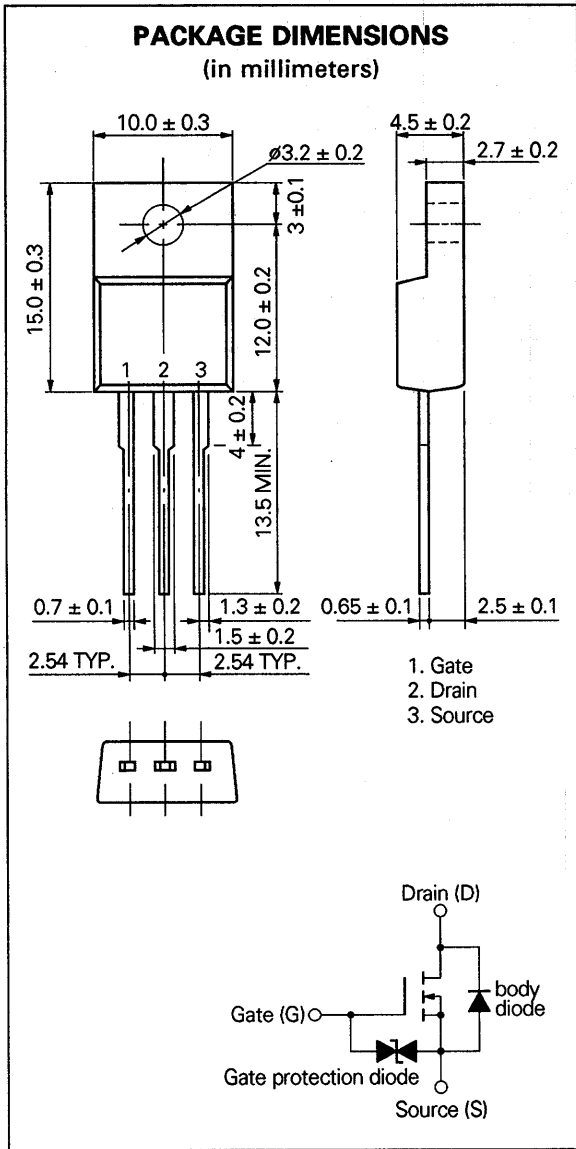

DESCRIPTION

The 2SK1290 is N-channel MOS Field Effect Transistor designed for solenoid, motor and lamp driver.

FEATURES

- Low On-state Resistance
 $R_{DS(on)} \leq 45 \text{ m}\Omega \text{ MAX. (} V_{GS} = 10 \text{ V, } I_D = 13 \text{ A)}$
 $R_{DS(on)} \leq 60 \text{ m}\Omega \text{ MAX. (} V_{GS} = 4 \text{ V, } I_D = 13 \text{ A)}$
- Low C_{iss} $C_{iss} = 2\ 200 \text{ pF TYP.}$
- Built-in G-S Gate Protection Diodes

QUALITY GRADE

Standard

Please refer to "Quality grade on NEC Semiconductor Devices" (Document number IEI-1209) published by NEC Corporation to know the specification of quality grade on the devices and its recommended applications.

ABSOLUTE MAXIMUM RATINGS

Maximum Temperatures

Storage Temperature	-55 to +150	°C
Channel Temperature	150	°C MAX.

Maximum Power Dissipation

Total Power Dissipation ($T_a = 25 \text{ }^\circ\text{C}$)	2.0	W
Total Power Dissipation ($T_c = 25 \text{ }^\circ\text{C}$)	35	W

Maximum Voltages and Currents ($T_a = 25 \text{ }^\circ\text{C}$)

V_{DSS}	Drain to Source Voltage	60	V
$V_{GSS(AC)}$	Gate to Source Voltage	± 20	V
$I_{D(DC)}$	Drain Current (DC)	± 25	A
$I_{D(pulse)*}$	Drain Current (pulse)	± 100	A

* $PW \leq 10 \text{ } \mu\text{s}$, Duty Cycle $\leq 1 \%$

ELECTRICAL CHARACTERISTICS (T_a = 25 °C)

CHARACTERISTIC	SYMBOL	MIN.	TYP.	MAX.	UNIT	TEST CONDITIONS
Drain to Source On-state Resistance	R _{DS(on)}		35	45	mΩ	V _{GS} = 10 V, I _D = 13 A
Drain to Source On-state Resistance	R _{DS(on)}		45	60	mΩ	V _{GS} = 4.0 V, I _D = 13 A
Gate to Source Cutoff Voltage	V _{GS(off)}	1.0		2.5	V	V _{DS} = 10 V, I _D = 1 mA
Forward Transfer Admittance	y _{fs}	12	25		S	V _{DS} = 10 V, I _D = 13 A
Drain Leakage Current	I _{DSS}			10	μA	V _{DS} = 60 V, V _{GS} = 0
Gate to Source Leakage Current	I _{GSS}			±10	μA	V _{GS} = ±20 V, V _{DS} = 0
Input Capacitance	C _{iss}		2 200		pF	V _{DS} = 10 V
Output Capacitance	C _{oss}		750		pF	V _{GS} = 0
Reverse Transfer Capacitance	C _{rss}		180		pF	f = 1 MHz
Turn-On Delay Time	t _{d(on)}		30		ns	V _{GS(on)} = 10 V
Rise Time	t _r		240		ns	V _{DD} = 30 V
Turn-Off Delay Time	t _{d(off)}		200		ns	I _D = 15 A, R _G = 10 Ω
Fall Time	t _f		140		ns	R _L = 2.0 Ω
Total Gate Charge	Q _G		50		nC	V _{GS} = 10 V
Gate to Source Charge	Q _{GS}		10		nC	I _D = 30 A
Gate to Drain Charge	Q _{GD}		10		nC	V _{DD} = 48 V
Diode Forward Voltage	V _{SD}		1.1		V	I _{SD} = 25 A, V _{GS} = 0
Reverse Recovery Time	t _{rr}		130		ns	I _F = 30 A, V _{GS} = 0
Reverse Recovery Charge	Q _{rr}		220		nC	di/dt = 50 A/μs

Test Circuit 1: Switching Time

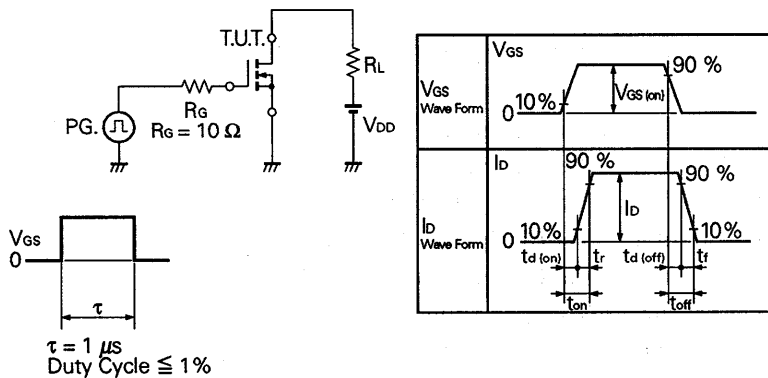

Test Circuit 2: Gate Charge

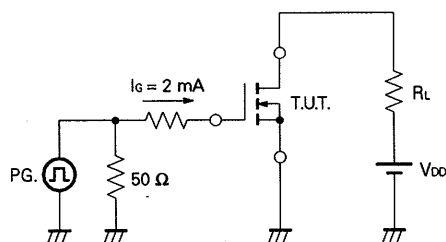

TYPICAL CHARACTERISTICS ($T_a = 25\text{ }^\circ\text{C}$)

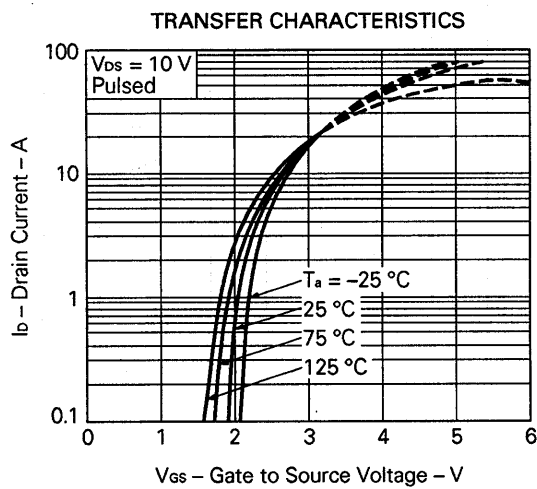
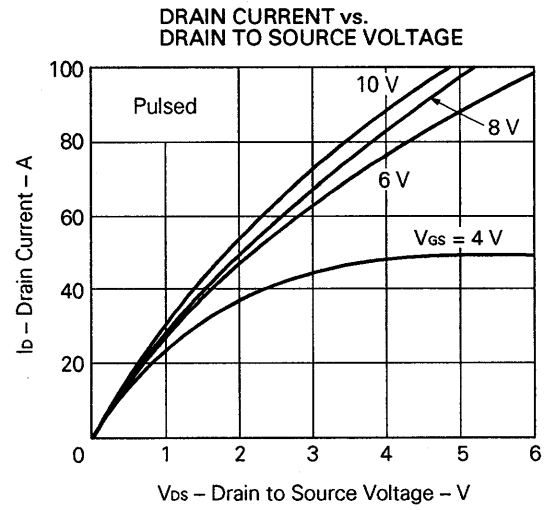
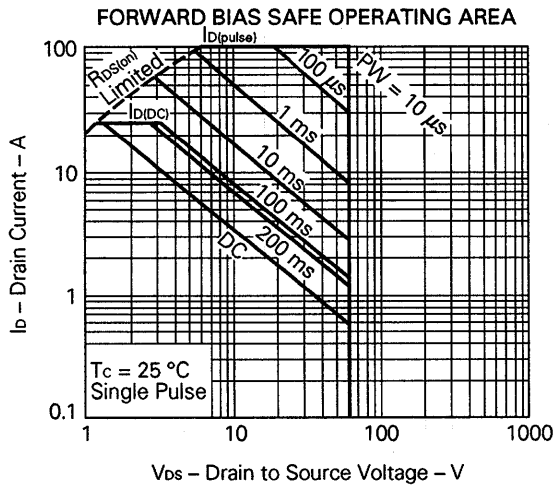
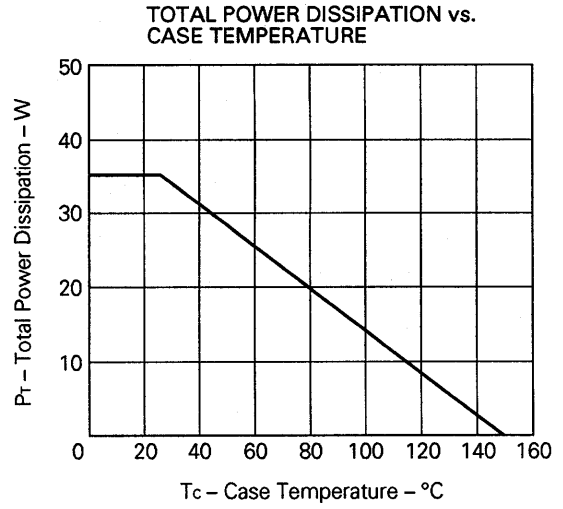
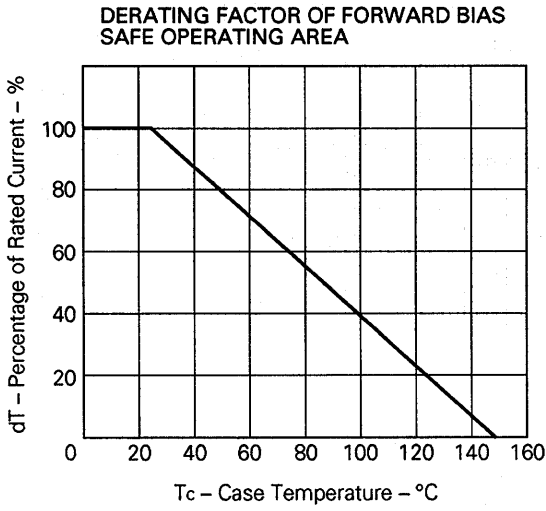

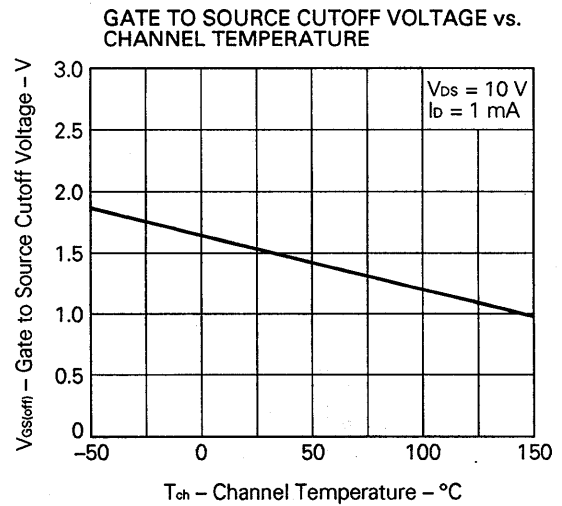
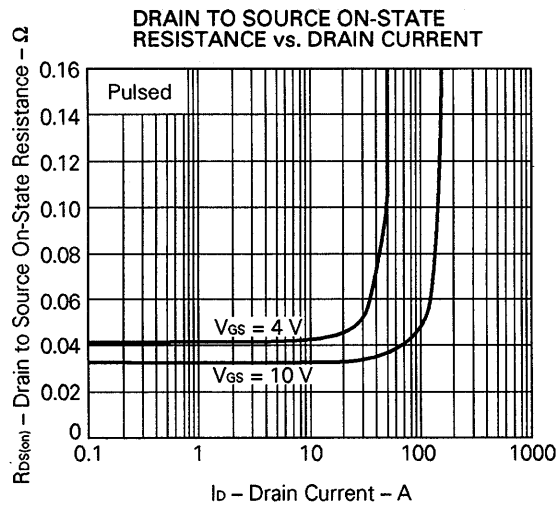
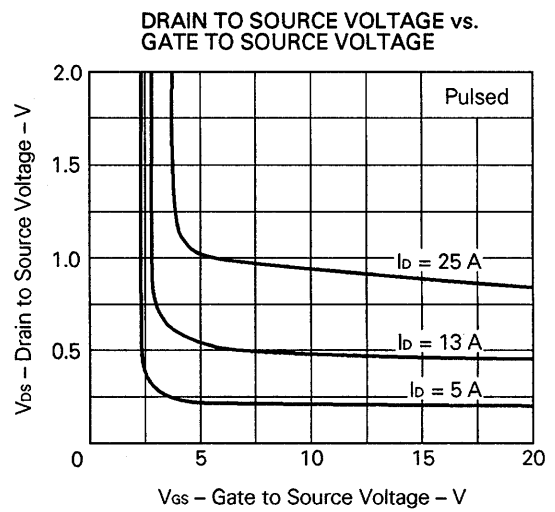
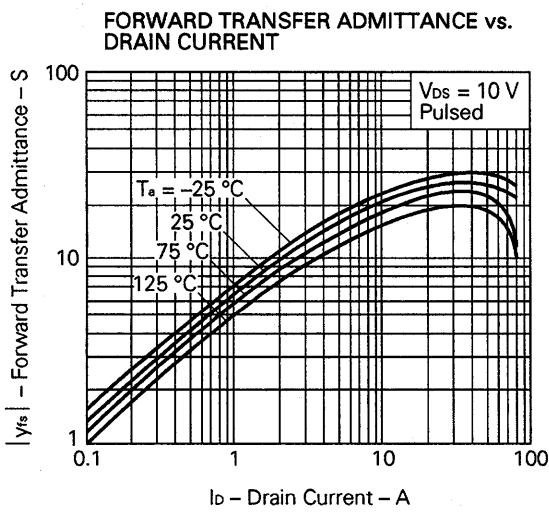
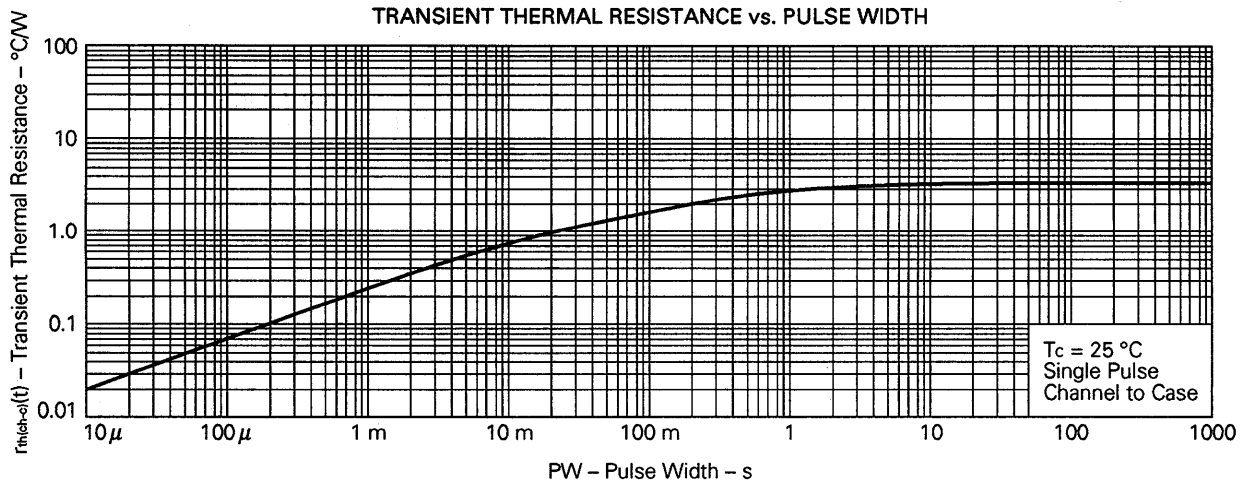

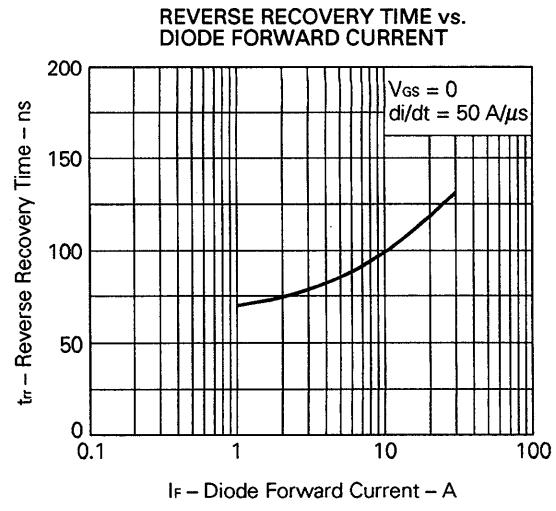
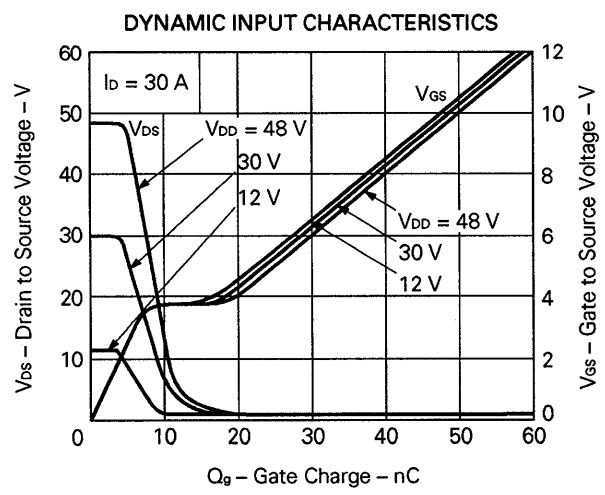
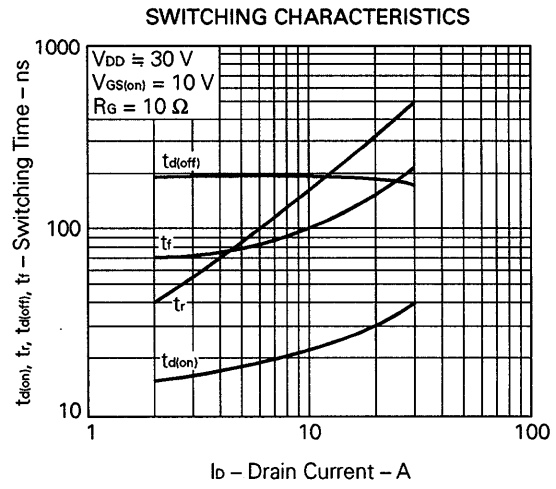
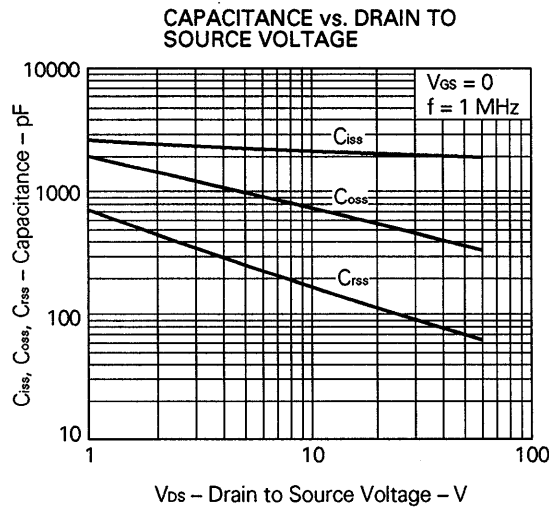
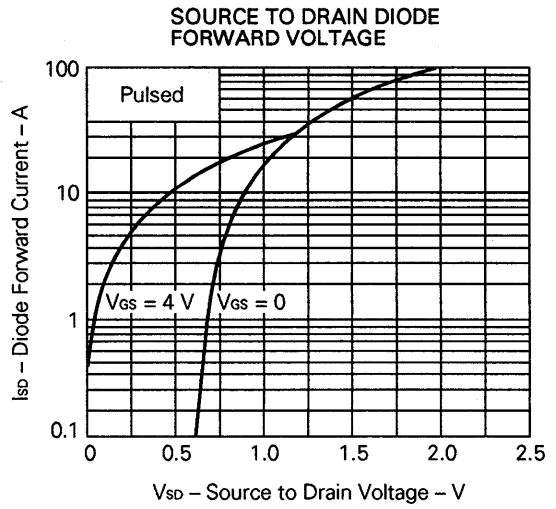
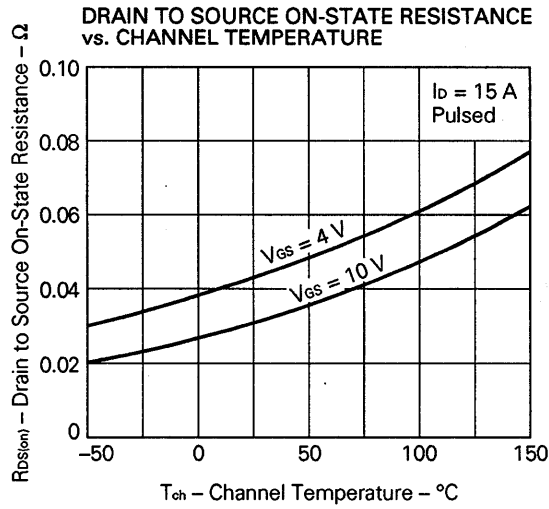

Reference

Application note name	No.
Safe operating area of Power MOS FET.	TEA-1034
Application circuit using Power MOS FET.	TEA-1035
Quality control of NEC semiconductors devices.	TEI-1202
Quality control guide of semiconductors devices.	MEI-1202
Assembly manual of semiconductors devices.	IEI-1207

[MEMO]

[MEMO]

No part of this document may be copied or reproduced in any form or by any means without the prior written consent of NEC Corporation. NEC Corporation assumes no responsibility for any errors which may appear in this document.

NEC Corporation does not assume any liability for infringement of patents, copyrights or other intellectual property rights of third parties by or arising from use of a device described herein or any other liability arising from use of such device. No license, either express, implied or otherwise, is granted under any patents, copyrights or other intellectual property rights of NEC Corporation or others.

The devices listed in this document are not suitable for use in aerospace equipment, submarine cables, nuclear reactor control systems and life support systems. If customers intend to use NEC devices for above applications or they intend to use "Standard" quality grade NEC devices for applications not intended by NEC, please contact our sales people in advance.

Application examples recommended by NEC Corporation.

Standard: Computer, Office equipment, Communication equipment, Test and Measurement equipment, Machine tools, Industrial robots, Audio and Visual equipment, Other consumer products, etc.

Special: Automotive and Transportation equipment, Traffic control systems, Antidisaster systems, Anticrime systems, etc.