

1.1 GHz AGC AMPLIFIER
 FOR DBS TUNER AND MOBILE TELEPHONE

FEATURES

- Wide frequency response – $f_u = 1.1 \text{ GHz}_{\text{TYP}} @ -3 \text{ dB } G_{\text{PMAX}}$.
- Maximum power gain – $G_{\text{PMAX}} = 13 \text{ dB}_{\text{TYP}}$
- Single supply voltage: 5 V, 15 mA TYP.
- AGC Dynamic range: $GCR = 38 \text{ dB TYP. @ } f = 500 \text{ MHz}$
- Packaged in 6 pins mini mold suitable for high-density surface mounting.

DESCRIPTION

The μ PC2723T is a silicon monolithic integrated circuit designed for miniature AGC amplifier. This amplifier realizes Auto gain control with external control circuit. This IC operates up to 1.1 GHz and therefore is suitable for DBS tuner, mobile telephone and other applications.

The μ PC2723T is manufactured using NEC's 20 GHz fr NESAT™ III silicon bipolar process. This process uses silicon nitride passivation film and gold metallization wirings. These materials can protect the chips from external pollution and prevent corrosion/migration. Thus, this IC has excellent performance, uniformity and reliability.

ORDER INFORMATION

ORDER NUMBER	PACKAGE	SUPPLYING FORM	MARKING
μ PC2723T-E3	6pin mini mold	Embossed tape 8mm wide. 3kp/reel. Pin1, 2, 3 face to perforation side of the tape.	C1M

Remarks To order evaluation samples, please contact your local NEC sales office. (Order number: μ PC2723T)

PIN CONNECTIONS

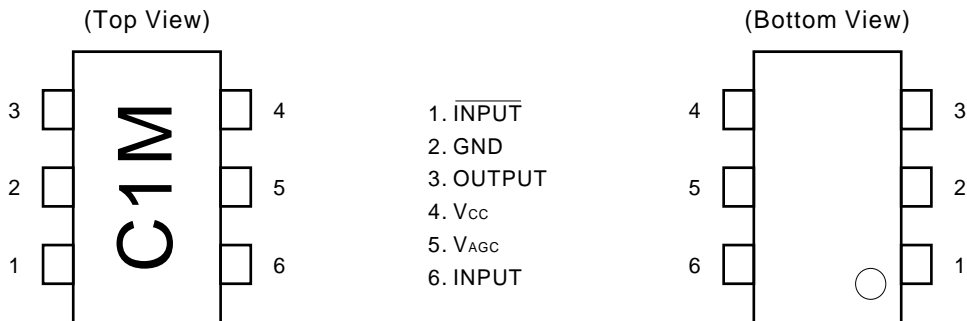

Caution: Electro-static sensitive device

ABSOLUTE MAXIMUM RATINGS

PARAMETER	SYMBOL	RATING	UNIT	CONDITION
Supply Voltage	V _{CC}	6.0	V	T _A = +25 °C
AGC Control Voltage	V _{AGC}	6.0	mA	T _A = +25 °C
Total Power Dissipation	P _D	280	mW	Mounted on double sided copper 50 × 50 × 1.6 mm epoxy glass PWB (T _A = +85 °C)
Operating Temperature	T _{opt}	-40 to +85	°C	
Storage Temperature	T _{stg}	-55 to +150	°C	
Input Power	P _{in}	0	dBm	T _A = +25 °C

RECOMMENDED OPERATING CONDITIONS

PARAMETER	SYMBOL	MIN.	TYP.	MAX.	UNIT
Supply Voltage	V _{CC}	4.5	5	5.5	V
Operating Temperature	T _{opt}	-40	+25	+85	°C

ELECTRICAL CHARACTERISTICS (T_A = 25 °C, V_{CC} = 5 V, Z_s = Z_L = 50 Ω)

PARAMETER	SYMBOL	MIN.	TYP.	MAX.	UNIT	CONDITION
Circuit Current	I _{CC}	11	15	19	mA	No signal
Maximum Power Gain	G _{PMAX}	9.5	13	14.5	dB	f = 500 MHz
Noise Figure	NF	-	11	13.5	dB	f = 500 MHz, at G _{PMAX}
Upper Limit Operating Frequency	f _u	0.8	1.1	-	GHz	3 dB down below flat gain f = 0.1 GHz at G _{PMAX}
AGC Dynamic Range	GCR	33	38	-	dB	f = 500 MHz, V _{AGC} = 0 to 5.0 V
Isolation	ISL	32	37	-	dB	f = 500 MHz, at G _{PMAX}
Input Return Loss	RL _{in}	9	12	-	dB	f = 500 MHz, at G _{PMAX}
Output Return Loss	RL _{out}	2	4	-	dB	f = 500 MHz, at G _{PMAX}
Maximum Output	P _{O(sat)}	-5	-2	-	dBm	f = 500 MHz, P _{in} = -5 dBm at G _{PMAX}

PIN DESCRIPTIONS

Pin No.	Symbol	Assignment	Functions and Explanation
1	$\overline{\text{IN}}$	Input bypass pin	Must be connected bypass capacitor (e.g. 1 500 pF) to minimize ground impedance.
2	GND	Ground pin	Must be connected to the system ground with minimum inductance. Ground pattern on the board should be formed as wide as possible. (Track length should be kept as short as possible)
3	OUT	Output pin	Must be coupled with capacitor (e.g. 1 500 pF) for DC cut.
4	V _{CC}	Power supply pin	Supply voltage 5.0 ± 0.5 V for operation. Must be connected bypass capacitor (e.g. 1 500 pF) to minimize ground impedance.
5	V _{AGC}	AGC control pin	Can be used for auto gain control. The control can be governed by supply voltage to this pin. AGC performance can be adjustable by R _{AGC} value. (e.g. 15 Ω).
6	IN	Input pin	Input frequency from an external VCO output. Must be coupled with capacitor (e.g. 1 500 pF).

TEST CIRCUIT

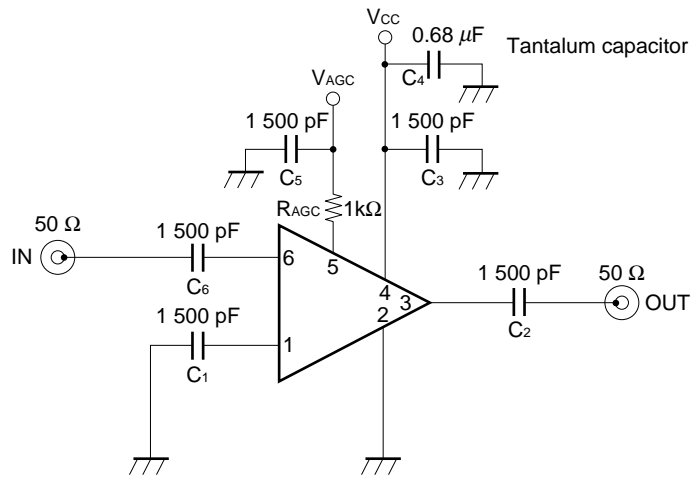

INTERNAL BLOCK DIAGRAM

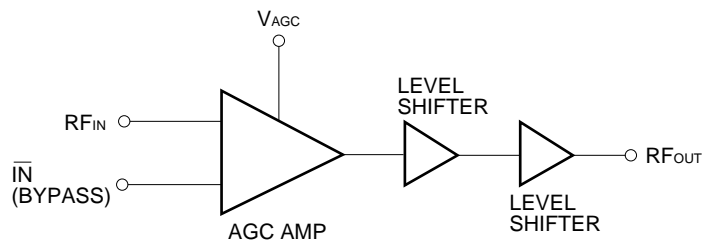

TYPICAL CHARACTERISTICS ($T_A = +25\text{ }^\circ\text{C}$)

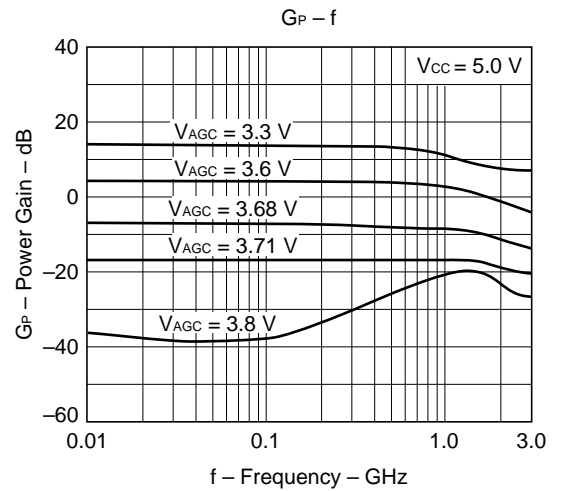
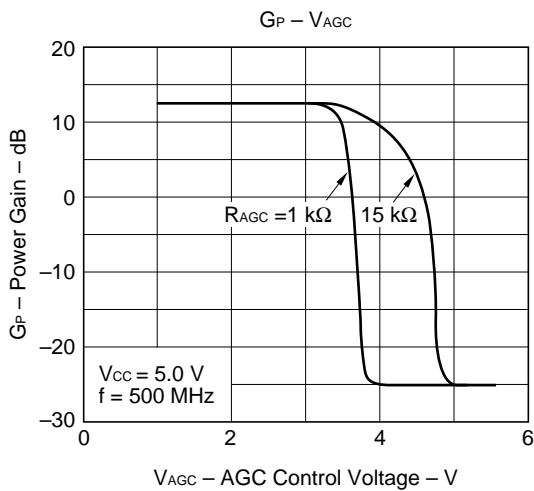
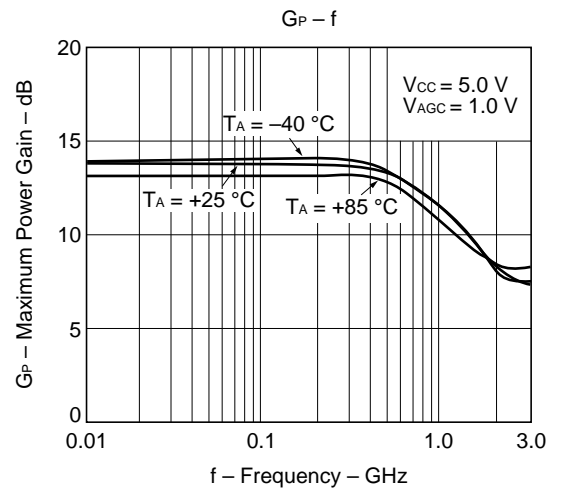
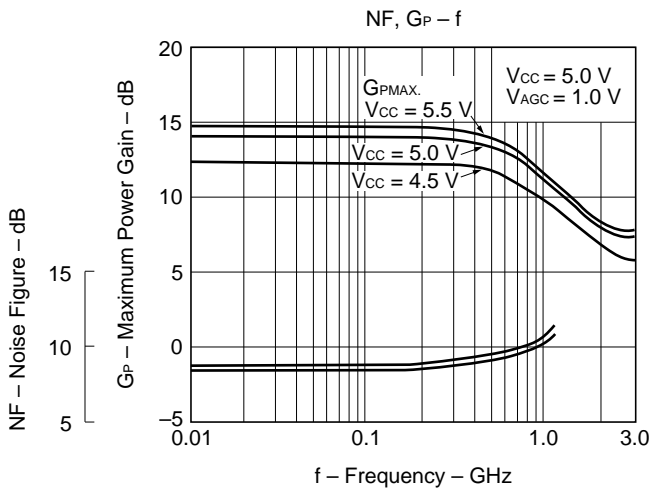
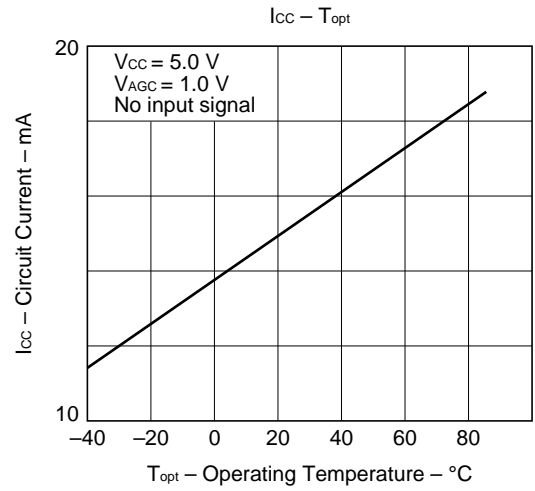
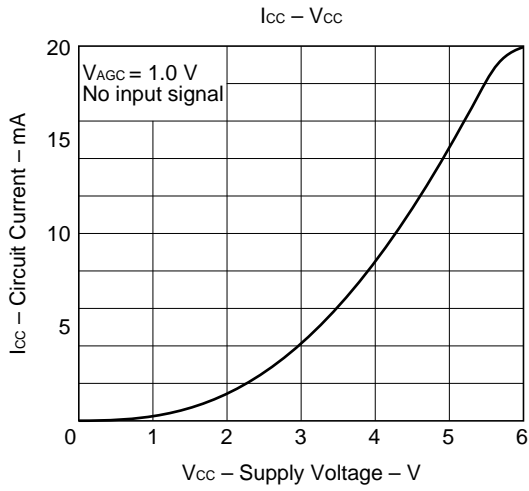

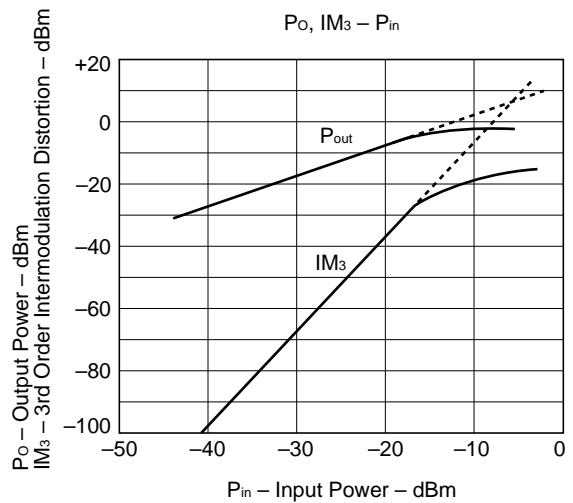
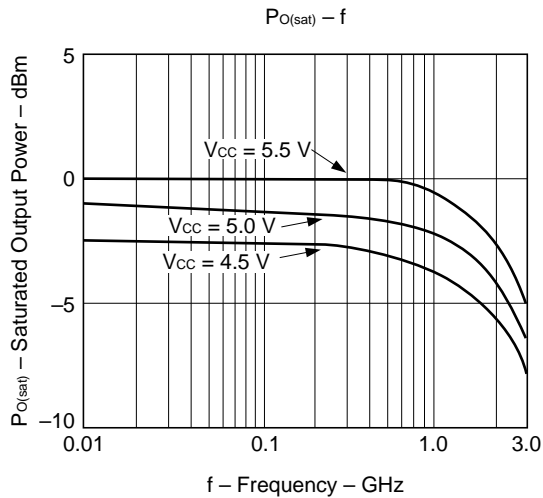
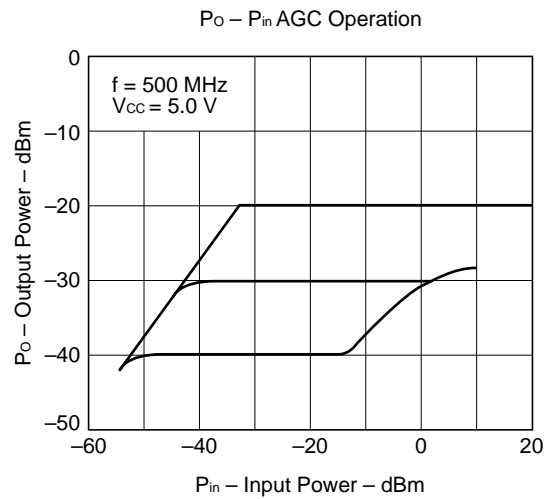
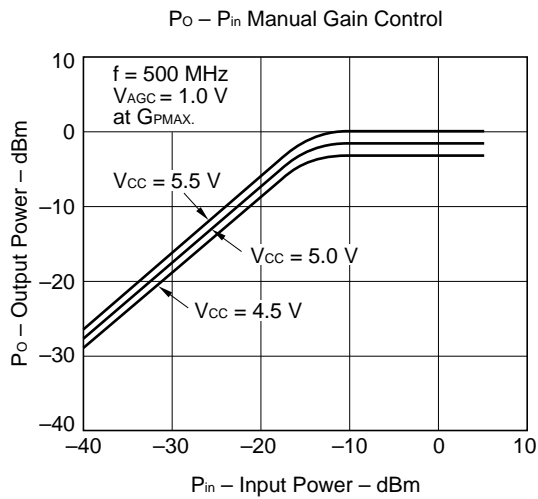
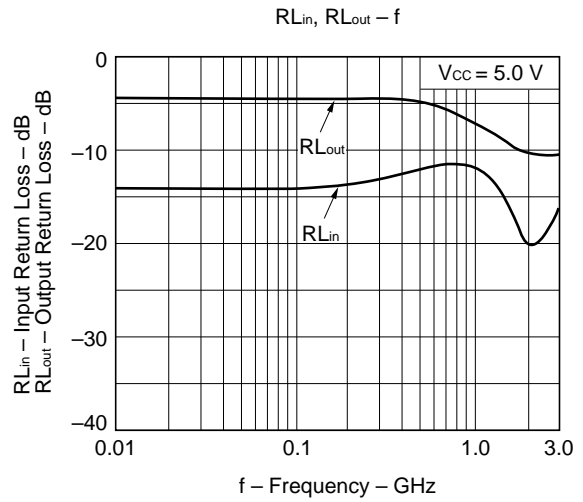
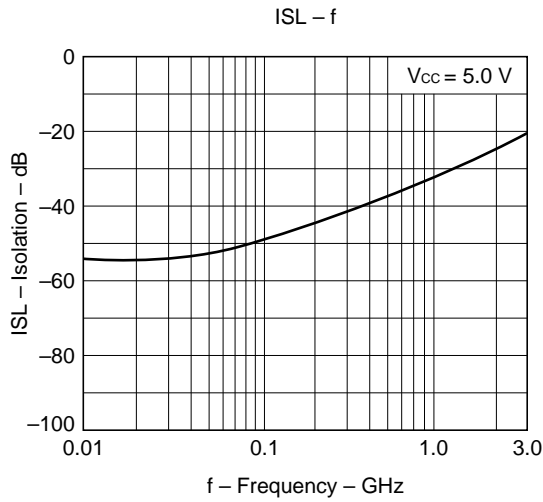

S PARAMETER ($V_{cc} = 5.0\text{ V}$)

S_{11} – FREQUENCY

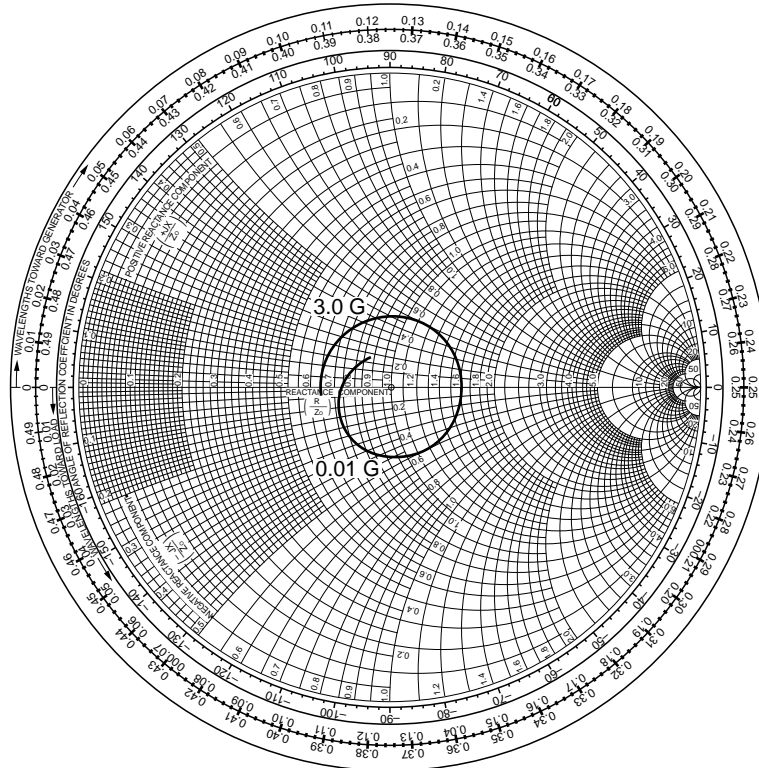

S_{22} – FREQUENCY

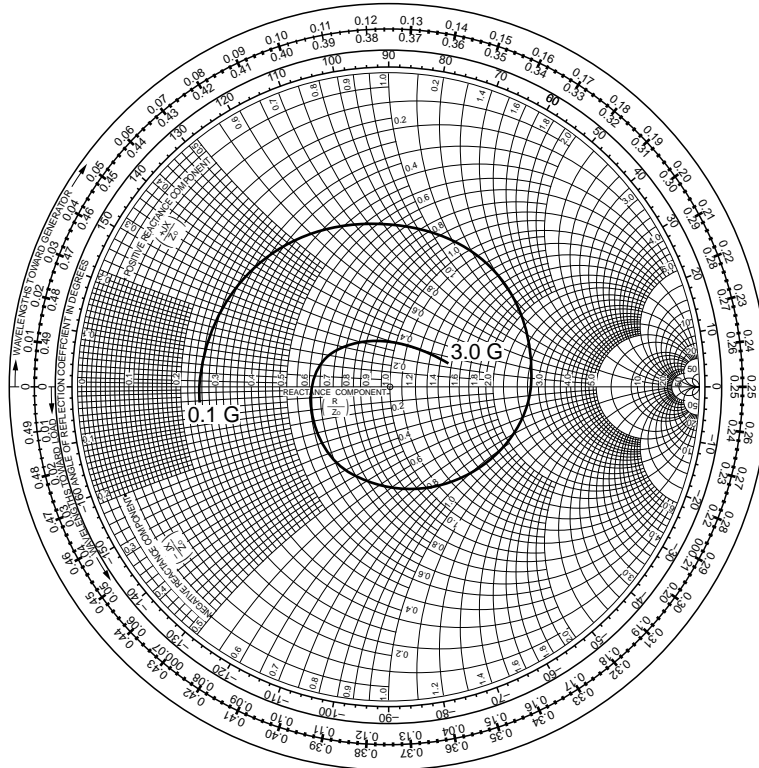
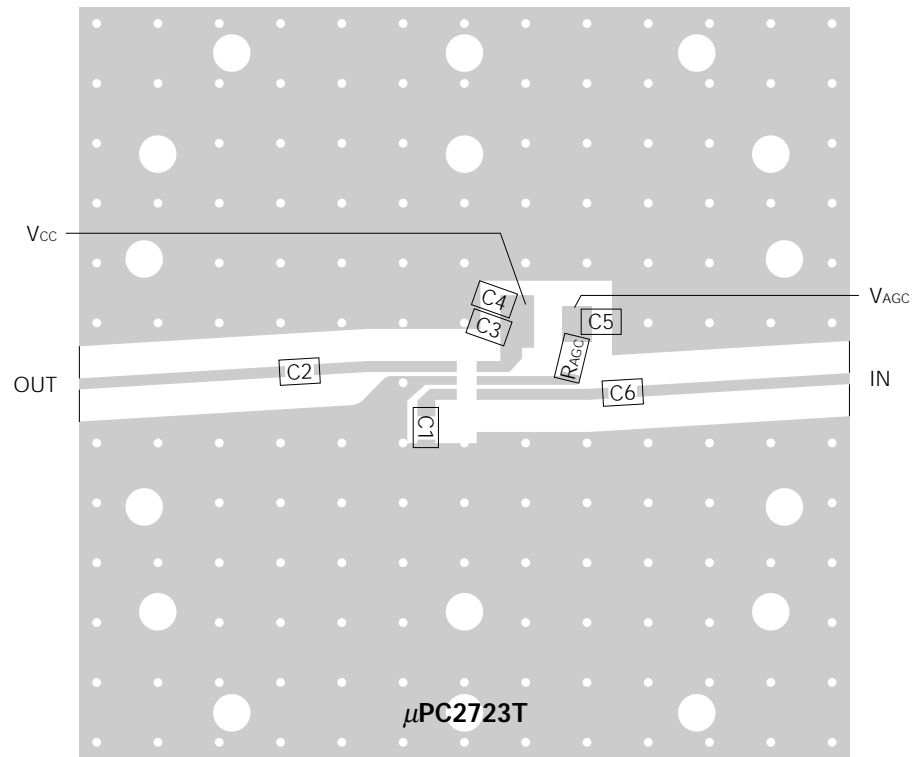

ILLUSTRATION OF THE TEST CIRCUIT ASSEMBLED ON EVALUATION BOARD



Component List

No.	Value
C _{1 to 3}	1 500 pF
C ₄	0.68 pF
C _{5 to 6}	1 500 pF
R _{AGC}	1 kΩ

Note

- (1) 50×50×0.4 mm double copper clad polyimide board.
- (2) Back side: GND pattern
- (3) Solder plated on pattern
- (4) ○○: Through holes

TYPICAL SYSTEM APPLICATION

DBS Tuner Block Diagram

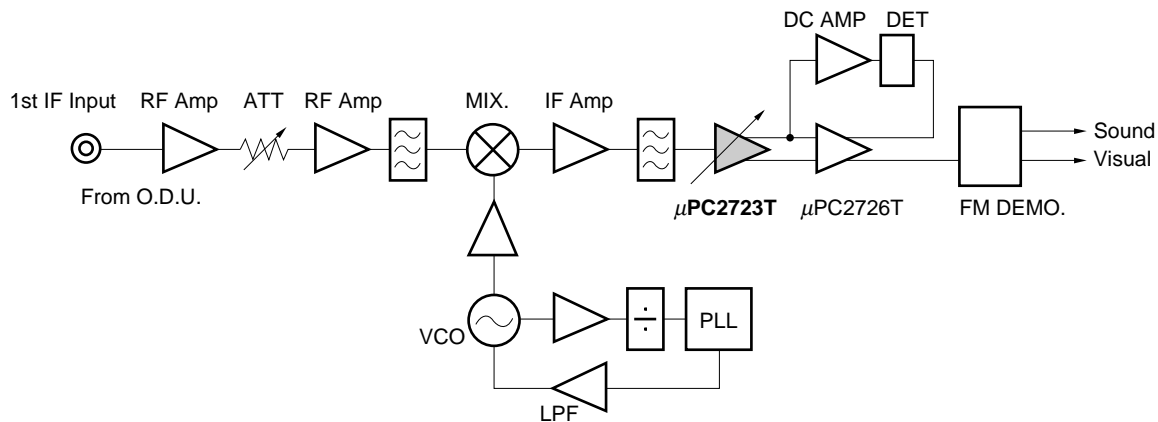

900 MHz Band Digital Cellular Block Diagram (5 V System)

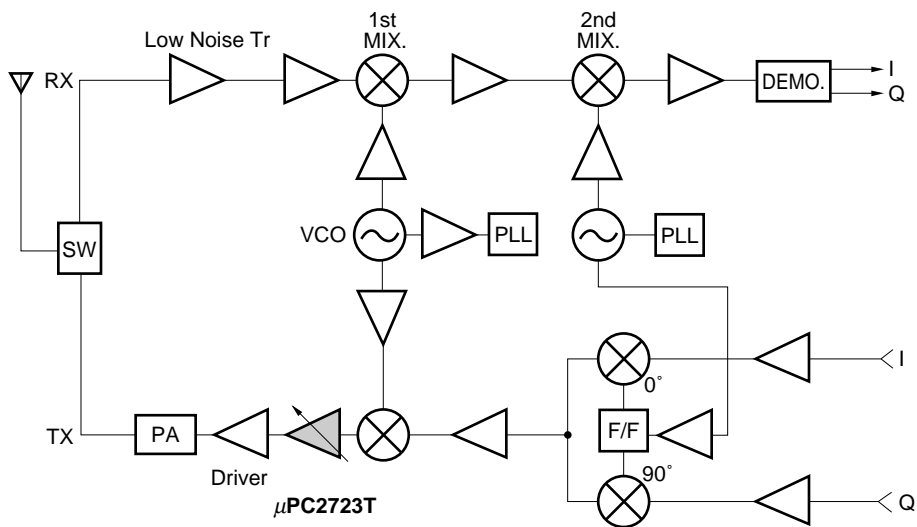

The application circuits and their parameters are for references only and are not intended for use in actual design-in's.

6 PINS MINI MOLD PACKAGE DIMENSIONS (Unit : mm)

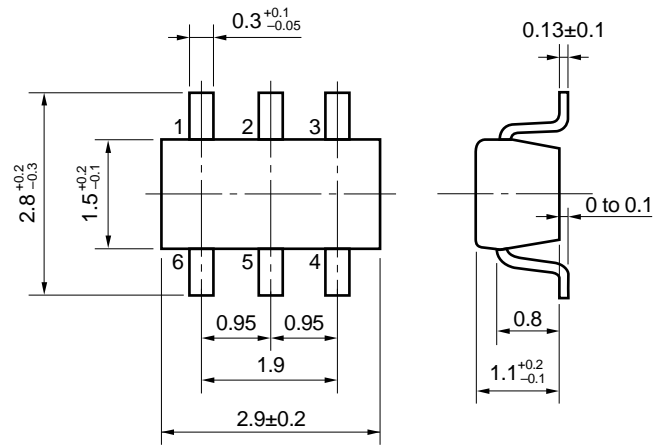

NOTE ON CORRECT USE

- (1) Observe precautions for handling because of electro-static sensitive devices.
- (2) Form a ground pattern as wide as possible to minimize ground impedance (to prevent undesired oscillation).
- (3) Keep the wiring length of the ground pins as short as possible.
- (4) Connect a bypass capacitor (e.g. 1 000 pF) to the Vcc pin.

RECOMMENDED SOLDERING CONDITIONS

This product should be soldered in the following recommended conditions. Other soldering methods and conditions than the recommended conditions are to be consulted with our sales representatives.

μPC2723T

Soldering method	Soldering conditions	Recommended condition symbol
Infrared ray reflow	Package peak temperature: 235 °C, Hour: within 30 s. (more than 210 °C), Time: 2 times, Limited days: no.*	IR35-00-2
VPS	Package peak temperature: 215 °C, Hour: within 40 s. (more than 200 °C), Time: 2 times, Limited days: no.*	VP15-00-2
Wave soldering	Soldering tub temperature: less than 260 °C, Hour: within 10 s. Time: 1 time, Limited days: no.	WS60-00-1
Pin part heating	Pin area temperature: less than 300 °C, Hour: within 3 s/pin. Limited days: no.*	

*: It is the storage days after opening a dry pack, the storage conditions are 25 °C, less than 65 % RH.

Note 1. The combined use of soldering method is to be avoided (However, except the pin area heating method).

For details of recommended soldering conditions for surface mounting, refer to information document SEMICONDUCTOR DEVICE MOUNTING TECHNOLOGY MANUAL (IEI-1207).

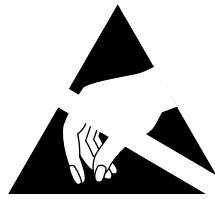

ATTENTION

OBSERVE PRECAUTIONS
FOR HANDLING
ELECTROSTATIC
SENSITIVE
DEVICES

No part of this document may be copied or reproduced in any form or by any means without the prior written consent of NEC Corporation. NEC Corporation assumes no responsibility for any errors which may appear in this document.

NEC Corporation does not assume any liability for infringement of patents, copyrights or other intellectual property rights of third parties by or arising from use of a device described herein or any other liability arising from use of such device. No license, either express, implied or otherwise, is granted under any patents, copyrights or other intellectual property rights of NEC Corporation or others.

While NEC Corporation has been making continuous effort to enhance the reliability of its semiconductor devices, the possibility of defects cannot be eliminated entirely. To minimize risks of damage or injury to persons or property arising from a defect in an NEC semiconductor device, customer must incorporate sufficient safety measures in its design, such as redundancy, fire-containment, and anti-failure features.

NEC devices are classified into the following three quality grades:

"Standard", "Special", and "Specific". The Specific quality grade applies only to devices developed based on a customer designated "quality assurance program" for a specific application. The recommended applications of a device depend on its quality grade, as indicated below. Customers must check the quality grade of each device before using it in a particular application.

Standard: Computers, office equipment, communications equipment, test and measurement equipment, audio and visual equipment, home electronic appliances, machine tools, personal electronic equipment and industrial robots

Special: Transportation equipment (automobiles, trains, ships, etc.), traffic control systems, anti-disaster systems, anti-crime systems, safety equipment and medical equipment (not specifically designed for life support)

Specific: Aircrafts, aerospace equipment, submersible repeaters, nuclear reactor control systems, life support systems or medical equipment for life support, etc.

The quality grade of NEC devices in "Standard" unless otherwise specified in NEC's Data Sheets or Data Books. If customers intend to use NEC devices for applications other than those specified for Standard quality grade, they should contact NEC Sales Representative in advance.

Anti-radioactive design is not implemented in this product.

M4 94.11

NESAT (NEC Silicon Advanced Technology) is a trademark of NEC Corporation.