

BIPOLAR ANALOG INTEGRATED CIRCUIT

μ PC2709T

5 V, MINIMOLD SILICON MMIC MEDIUM OUTPUT POWER AMPLIFIER

DESCRIPTION

The μ PC2709T is a silicon monolithic integrated circuit designed as 1st IF amplifier for DBS tuners. This IC is packaged in minimold package.

This IC is manufactured using NEC's 20 GHz fr NESAT™III silicon bipolar process. This process uses silicon nitride passivation film and gold electrodes. These materials can protect chip surface from external pollution and prevent corrosion/migration. Thus, this IC has excellent performance, uniformity and reliability.

FEATURES

- Supply voltage : $V_{CC} = 4.5$ to 5.5 V
- Wideband response : $f_u = 2.3$ GHz TYP. @3 dB bandwidth
- Medium output power : $P_{O(sat)} = +11.5$ dBm@ $f = 1$ GHz with external inductor
- Power gain : $G_P = 23$ dB TYP. @ $f = 1$ GHz
- Port impedance : input/output 50Ω

APPLICATIONS

- 1st IF amplifiers in DBS converters
- RF stage buffer in DBS tuners, etc.

ORDERING INFORMATION

Part Number	Package	Marking	Supplying Form
μ PC2709T-E3	6-pin minimold	C1E	Embossed tape 8 mm wide. 1, 2, 3 pins face the perforation side of the tape. Qty 3 kpcs/reel.

Remark To order evaluation samples, please contact your local NEC sales office. (Part number for sample order: μ PC2709T)

Caution Electro-static sensitive devices

The information in this document is subject to change without notice. Before using this document, please confirm that this is the latest version.
Not all devices/types available in every country. Please check with local NEC representative for availability and additional information.

PIN CONNECTIONS

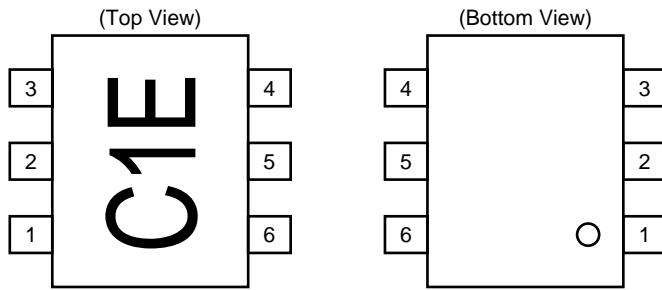

Pin No.	Pin Name
1	INPUT
2	GND
3	GND
4	OUTPUT
5	GND
6	V _{CC}

PRODUCT LINE-UP OF μ PC2709 (T_A = +25°C, V_{CC} = V_{out} = 5.0 V, Z_S = Z_L = 50 Ω)

Part No.	f _u (GHz)	P _{O (sat)} (dBm)	G _P (dB)	NF (dB)	I _{cc} (mA)	Package	Marking
μ PC2709T	2.3	+11.5	23	5	25	6-pin minimold	C1E
μ PC2709TB						6-pin super minimold	

Remark Typical performance. Please refer to ELECTRICAL CHARACTERISTICS in detail.

Caution The package size distinguishes between minimold and super minimold.

SYSTEM APPLICATION EXAMPLE

EXAMPLE OF DBS CONVERTERS

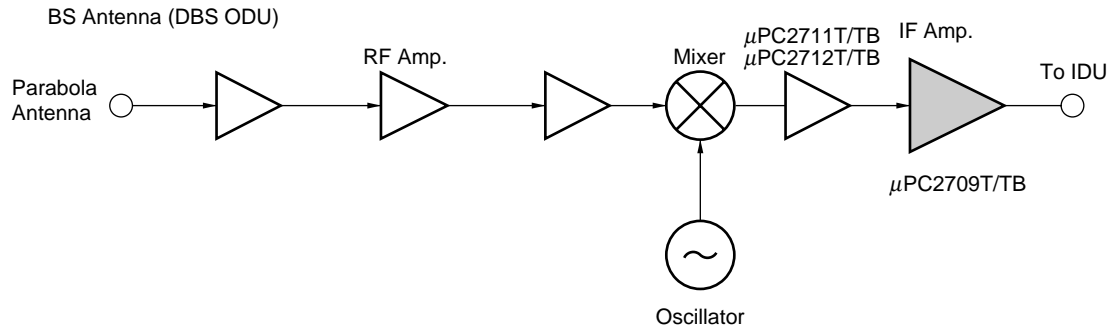

EXAMPLE OF 900 MHz BAND, 1.5 GHz BAND DIGITAL CELLULAR TELEPHONE

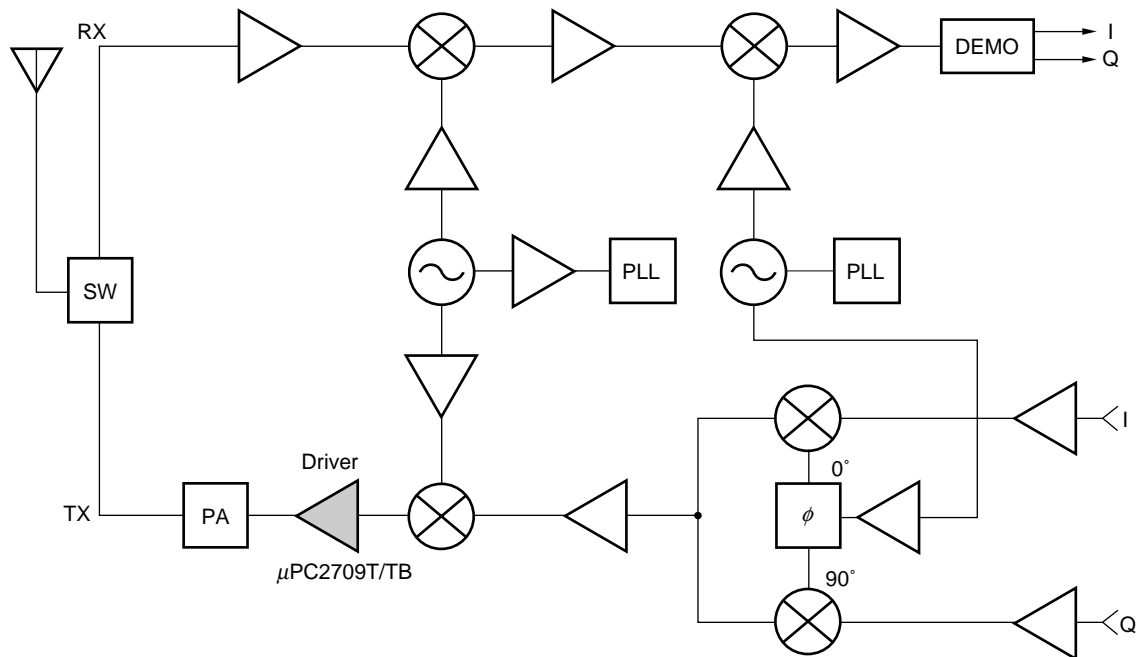

To know the associated products, please refer to each latest data sheet.

PIN EXPLANATION

Pin No.	Pin Name	Applied Voltage (V)	Pin Voltage (V) ^{Note}	Function and Applications	Internal Equivalent Circuit
1	INPUT	–	1.05	Signal input pin. A internal matching circuit, configured with resistors, enables 50 Ω connection over a wide band. A multi-feedback circuit is designed to cancel the deviations of h _{FE} and resistance. This pin must be coupled to signal source with capacitor for DC cut.	
4	OUTPUT	Voltage as same as V _{cc} through external inductor	–	Signal output pin. The inductor must be attached between V _{cc} and output pins to supply current to the internal output transistors.	
6	V _{cc}	4.5 to 5.5	–	Power supply pin, which biases the internal input transistor. This pin should be externally equipped with bypass capacitor to minimize its impedance.	
2 3 5	GND	0	–	Ground pin. This pin should be connected to system ground with minimum inductance. Ground pattern on the board should be formed as wide as possible. All the ground pins must be connected together with wide ground pattern to decrease impedance difference.	

Note Pin voltage is measured at V_{cc} = 5.0 V

ABSOLUTE MAXIMUM RATINGS

Parameter	Symbol	Ratings	Unit	Conditions
Supply Voltage	V _{CC}	6	V	T _A = +25°C, Pin 4 and 6
Total Circuit Current	I _{CC}	60	mA	T _A = +25°C
Power Dissipation	P _D	280	mW	Mounted on double copper clad 50 × 50 × 1.6 mm epoxy glass PWB (T _A = +85°C)
Operating Ambient Temperature	T _A	-40 to +85	°C	
Storage Temperature	T _{stg}	-55 to +150	°C	
Input Power	P _{in}	+10	dBm	T _A = +25°C

RECOMMENDED OPERATING CONDITIONS

Parameter	Symbol	MIN.	TYP.	MAX.	Unit	Notice
Supply Voltage	V _{CC}	4.5	5.0	5.5	V	The same voltage should be applied to pin 4 and 6.
Operating Ambient Temperature	T _A	-40	+25	+85	°C	

ELECTRICAL CHARACTERISTICS (T_A = +25°C, V_{CC} = V_{out} = 5.0 V, Z_S = Z_L = 50 Ω)

Parameter	Symbol	Test Conditions	MIN.	TYP.	MAX.	Unit
Circuit Current	I _{CC}	No Signal	19	25	32	mA
Power Gain	G _P	f = 1 GHz	21.0	23.0	26.5	dB
Maximum Output Level	P _{O (sat)}	f = 1 GHz, P _{in} = 0 dBm	+9.0	+11.5	-	dBm
Noise Figure	NF	f = 1 GHz	-	5.0	6.5	dB
Upper Limit Operating Frequency	f _u	3 dB down below flat gain at f = 0.1 GHz	2.0	2.3	-	GHz
Isolation	ISL	f = 1 GHz	26	31	-	dB
Input Return Loss	RL _{in}	f = 1 GHz	7	10	-	dB
Output Return Loss	RL _{out}	f = 1 GHz	7	10	-	dB
Gain Flatness	ΔG _P	f = 0.1 to 1.8 GHz	-	±1.0	-	dB

TEST CIRCUIT

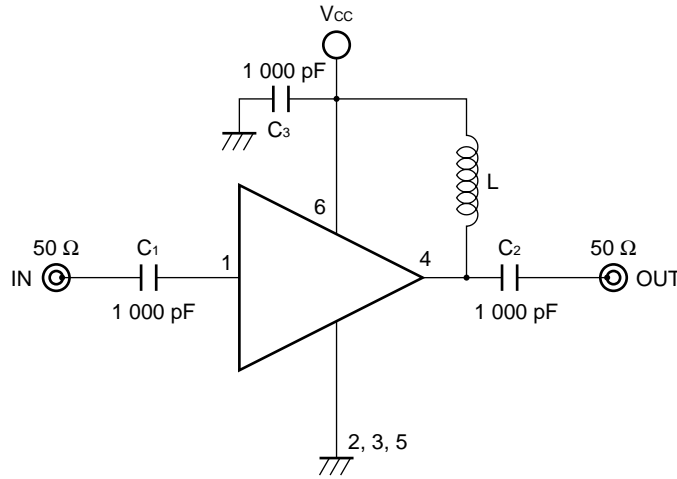

COMPONENTS OF TEST CIRCUIT FOR MEASURING ELECTRICAL CHARACTERISTICS

EXAMPLE OF ACTUAL APPLICATION COMPONENTS

	Type	Value
C ₃	Capacitor	1 000 pF
L	Bias Tee	1 000 nH
C ₁ to C ₂	Bias Tee	1 000 pF

	Type	Value	Operating Frequency
C ₁ to C ₃	Chip Capacitor	1 000 pF	100 MHz or higher
L	Chip Inductor	300 nH	10 MHz or higher
		100 nH	100 MHz or higher
		10 nH	1.0 GHz or higher

INDUCTOR FOR THE OUTPUT PIN

The internal output transistor of this IC consumes 20 mA, to output medium power. To supply current for output transistor, connect an inductor between the Vcc pin (pin 6) and output pin (pin 4). Select large value inductance, as listed above.

The inductor has both DC and AC effects. In terms of DC, the inductor biases the output transistor with minimum voltage drop to output enable high level. In terms of AC, the inductor make output-port impedance higher to get enough gain. In this case, large inductance and Q is suitable.

CAPACITORS FOR THE Vcc, INPUT AND OUTPUT PINS

Capacitors of 1 000 pF are recommendable as the bypass capacitor for the Vcc pin and the coupling capacitors for the input and output pins.

The bypass capacitor connected to the Vcc pin is used to minimize ground impedance of Vcc pin. So, stable bias can be supplied against Vcc fluctuation.

The coupling capacitors, connected to the input and output pins, are used to cut the DC and minimize RF serial impedance. Their capacitance are therefore selected as lower impedance against a 50 Ω load. The capacitors thus perform as high pass filters, suppressing low frequencies to DC.

To obtain a flat gain from 100 MHz upwards, 1 000 pF capacitors are used in the test circuit. In the case of under 10 MHz operation, increase the value of coupling capacitor such as 10 000 pF. Because the coupling capacitors are determined by equation, $C = 1/(2 \pi Rfc)$.

ILLUSTRATION OF APPLICATION CIRCUIT ASSEMBLED ON EVALUATION BOARD

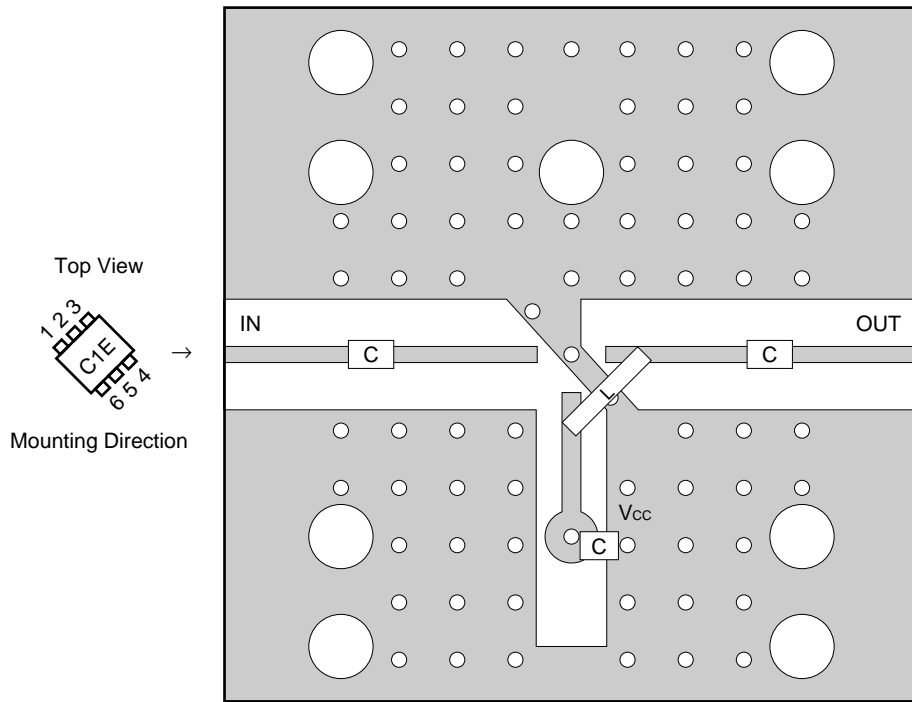

COMPONENT LIST

	Value
C	1 000 pF
L	300 nH

Notes

1. 30 × 30 × 0.4 mm double sided copper clad polyimide board.
2. Back side: GND pattern
3. Solder plated on pattern
4. ○ ○ : Through holes

For more information on the use of this IC, refer to the following application note: USAGE AND APPLICATION OF SILICON MEDIUM-POWER HIGH-FREQUENCY AMPLIFIER MMIC (P12152E).

TYPICAL CHARACTERISTICS ($T_A = +25^\circ\text{C}$ unless otherwise specified)

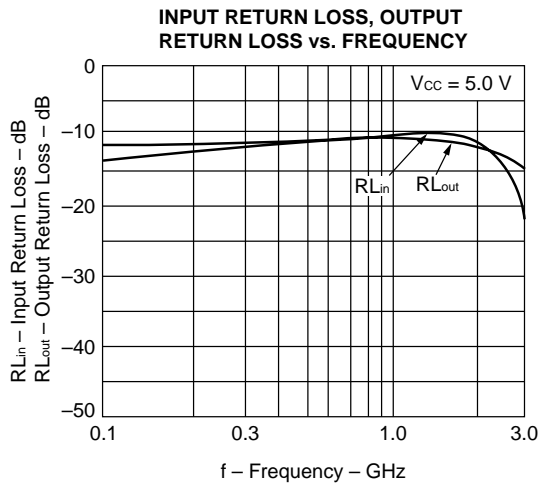
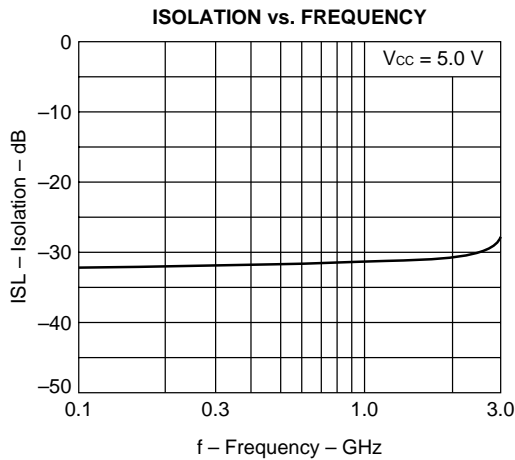
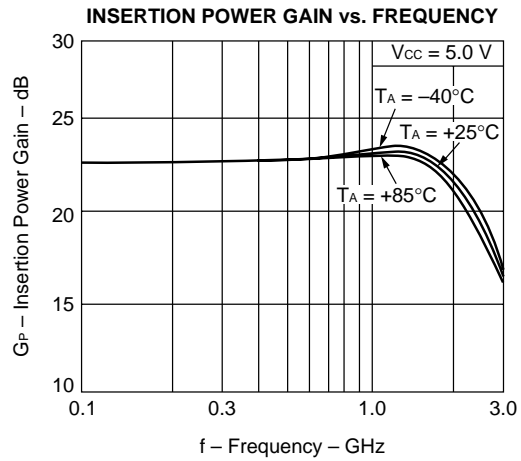
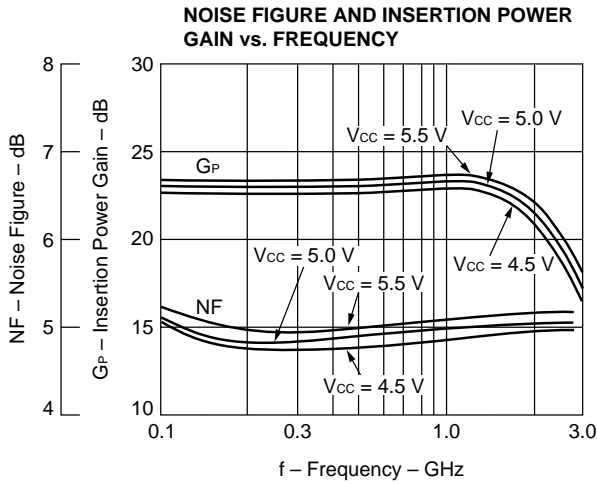
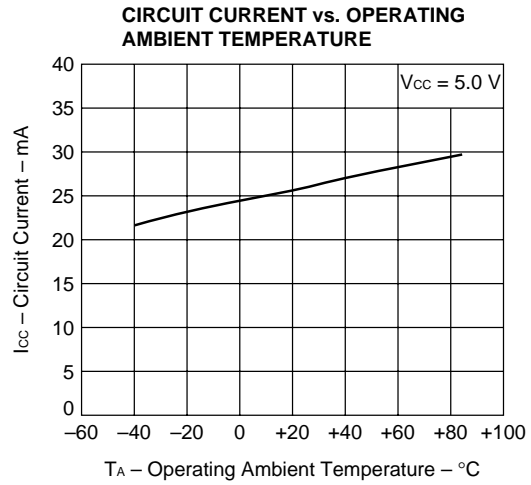
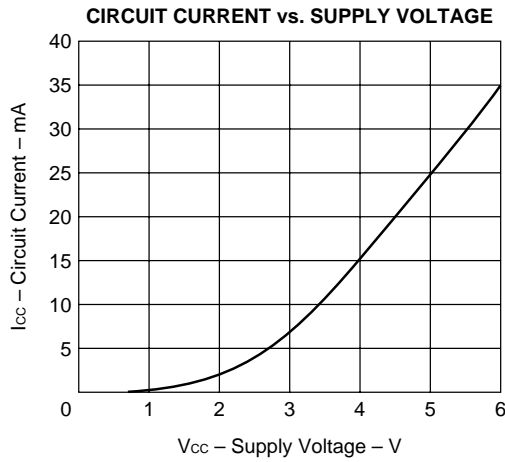

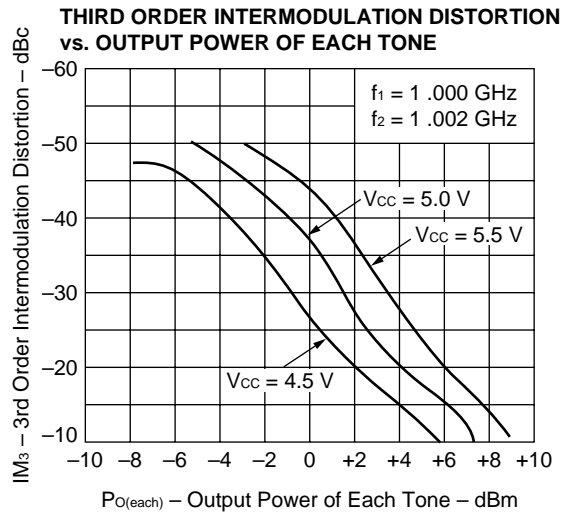
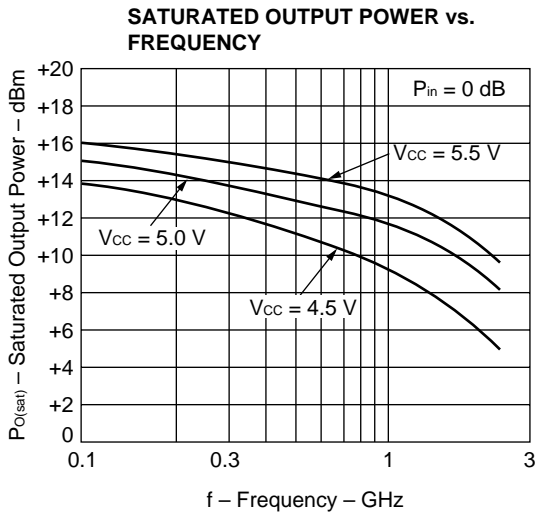
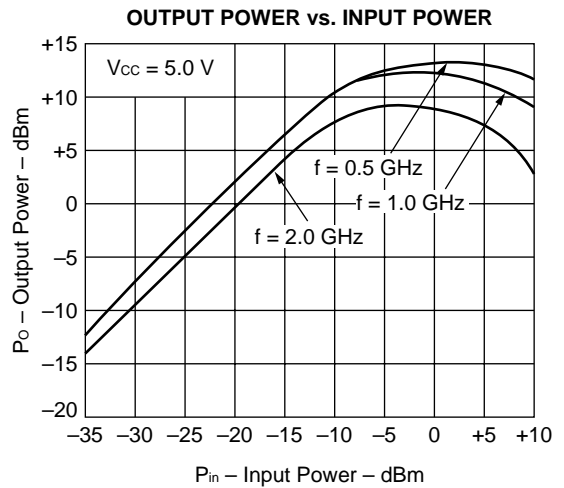
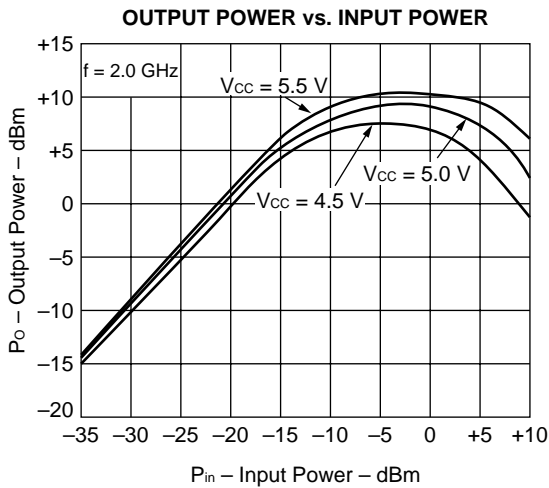
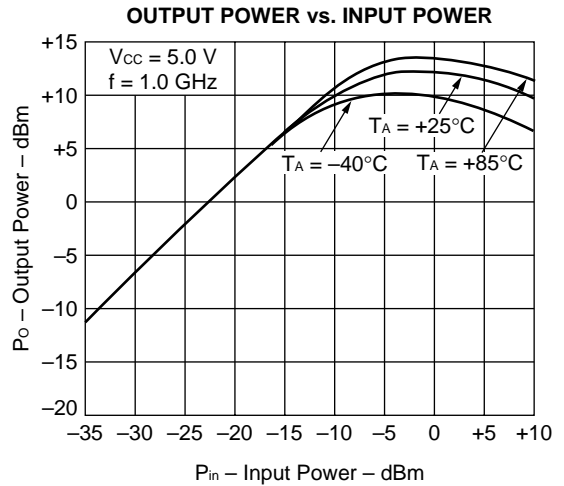
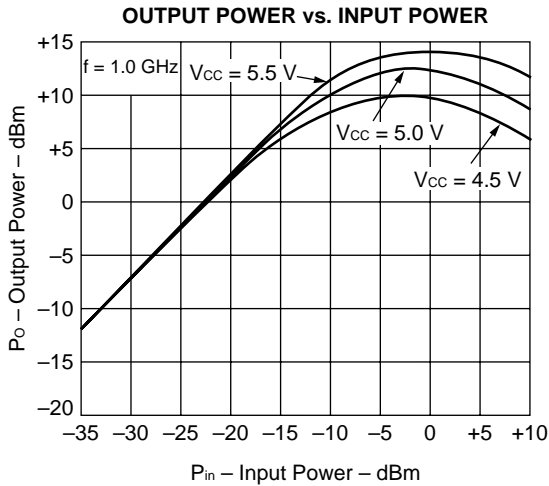

S-PARAMETER ($V_{CC} = V_{out} = 5.0\text{ V}$)

S₁₁-FREQUENCY

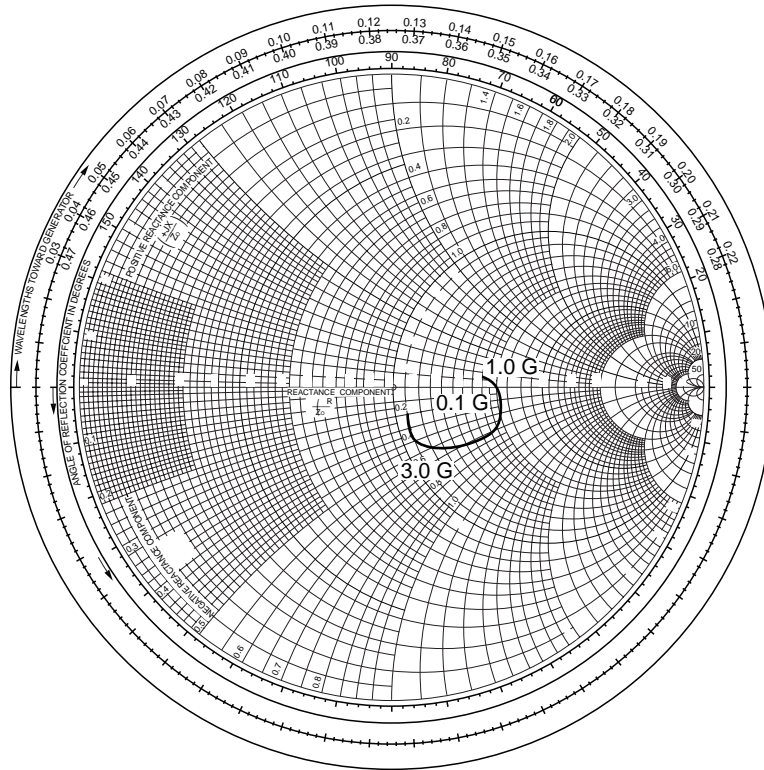

S₂₂-FREQUENCY

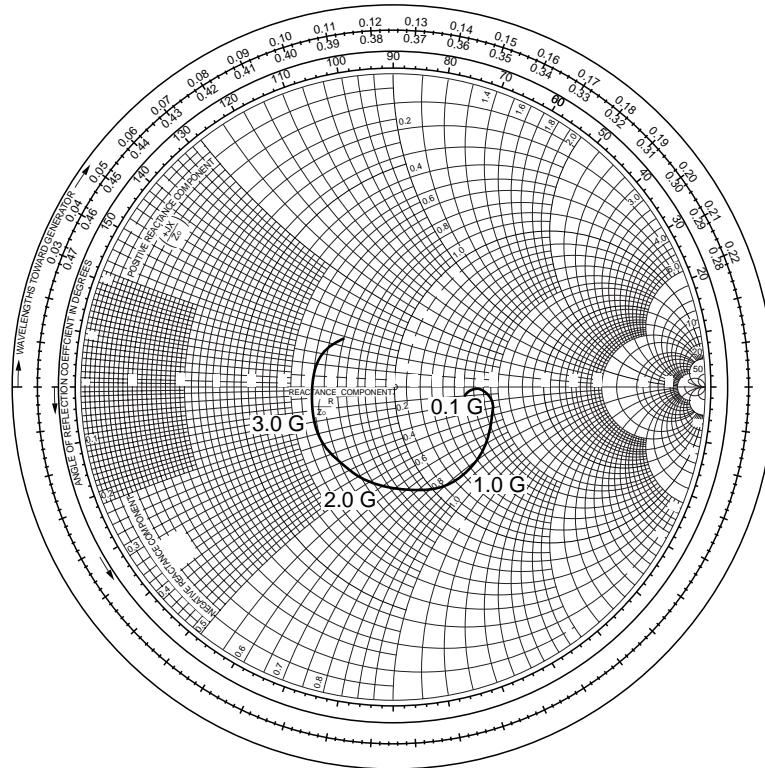

TYPICAL S-PARAMETER VALUES (T_A = +25°C)

μPC2709T

V_{CC} = V_{out} = 5.0 V, I_{CC} = 30 mA

Frequency MHz	S11		S21		S12		S22		K
	MAG	ANG	MAG	ANG	MAG	ANG	MAG	ANG	
100.0000	.258	-4.1	12.706	-3.7	.022	7.5	.234	-4.6	1.66
200.0000	.261	-2.9	12.793	-12.2	.024	3.1	.240	-6.9	1.52
400.0000	.271	-4.6	13.023	-27.0	.025	6.5	.260	-13.5	1.32
600.0000	.275	-8.1	13.305	-41.3	.026	10.5	.288	-22.1	1.29
800.0000	.278	-12.7	13.595	-57.4	.026	11.0	.312	-33.5	1.27
1000.0000	.279	-15.2	13.816	-72.3	.027	15.6	.324	-43.4	1.20
1200.0000	.276	-20.7	13.992	-90.3	.027	17.7	.332	-59.0	1.19
1400.0000	.263	-25.6	13.750	-109.3	.027	19.2	.326	-75.1	1.22
1600.0000	.246	-28.6	13.195	-128.3	.028	20.6	.302	-90.6	1.27
1800.0000	.237	-31.7	12.254	-147.5	.030	27.9	.254	-106.8	1.33
2000.0000	.222	-33.6	10.976	-166.1	.031	33.2	.198	-120.8	1.47
2200.0000	.194	-33.1	9.664	177.5	.033	35.8	.143	-132.5	1.61
2400.0000	.176	-26.8	8.392	162.0	.034	38.5	.089	-144.4	1.81
2500.0000	.173	-23.2	7.771	154.8	.035	39.2	.065	-150.6	1.90

PACKAGE DIMENSIONS

6 pin minimold (Unit: mm)

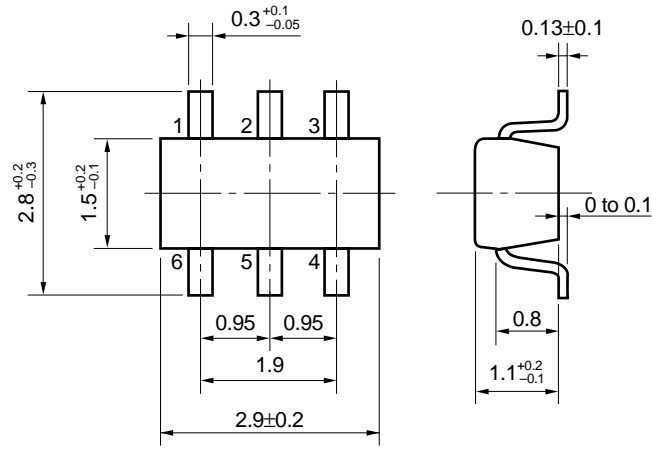

NOTES ON CORRECT USE

- (1) Observe precautions for handling because of electro-static sensitive devices.
- (2) Form a ground pattern as wide as possible to minimize ground impedance (to prevent undesired oscillation).
All the ground pins must be connected together with wide ground pattern to decrease impedance difference.
- (3) The bypass capacitor should be attached to Vcc line.
- (4) The inductor must be attached between Vcc and output pins. The inductance value should be determined in accordance with desired frequency.
- (5) The DC cut capacitor must be attached to input pin.

RECOMMENDED SOLDERING CONDITIONS

This product should be soldered under the following recommended conditions. For soldering methods and conditions other than those recommended below, contact your NEC sales representative.

Soldering Method	Soldering Conditions	Recommended Condition Symbol
Infrared Reflow	Package peak temperature: 235°C or below Time: 30 seconds or less (at 210°C) Count: 3, Exposure limit ^{Note} : None	IR35-00-3
VPS	Package peak temperature: 215°C or below Time: 40 seconds or less (at 200°C) Count: 3, Exposure limit ^{Note} : None	VP15-00-3
Wave Soldering	Soldering bath temperature: 260°C or below Time: 10 seconds or less Count: 1, Exposure limit ^{Note} : None	WS60-00-1
Partial Heating	Pin temperature: 300°C Time: 3 seconds or less (per side of device) Exposure limit ^{Note} : None	_____

Note After opening the dry pack, keep it in a place below 25°C and 65% RH for the allowable storage period.

Caution Do not use different soldering methods together (except for partial heating).

For details of recommended soldering conditions for surface mounting, refer to information document SEMICONDUCTOR DEVICE MOUNTING TECHNOLOGY MANUAL (C10535E).

[MEMO]

[MEMO]

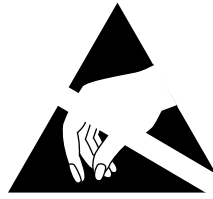

ATTENTION

OBSERVE PRECAUTIONS
FOR HANDLING
ELECTROSTATIC
SENSITIVE
DEVICES

NESAT (NEC Silicon Advanced Technology) is a trademark of NEC Corporation.

- **The information in this document is subject to change without notice. Before using this document, please confirm that this is the latest version.**
 - No part of this document may be copied or reproduced in any form or by any means without the prior written consent of NEC Corporation. NEC Corporation assumes no responsibility for any errors which may appear in this document.
 - NEC Corporation does not assume any liability for infringement of patents, copyrights or other intellectual property rights of third parties by or arising from use of a device described herein or any other liability arising from use of such device. No license, either express, implied or otherwise, is granted under any patents, copyrights or other intellectual property rights of NEC Corporation or others.
 - Descriptions of circuits, software, and other related information in this document are provided for illustrative purposes in semiconductor product operation and application examples. The incorporation of these circuits, software, and information in the design of the customer's equipment shall be done under the full responsibility of the customer. NEC Corporation assumes no responsibility for any losses incurred by the customer or third parties arising from the use of these circuits, software, and information.
 - While NEC Corporation has been making continuous effort to enhance the reliability of its semiconductor devices, the possibility of defects cannot be eliminated entirely. To minimize risks of damage or injury to persons or property arising from a defect in an NEC semiconductor device, customers must incorporate sufficient safety measures in its design, such as redundancy, fire-containment, and anti-failure features.
 - NEC devices are classified into the following three quality grades:
"Standard", "Special", and "Specific". The Specific quality grade applies only to devices developed based on a customer designated "quality assurance program" for a specific application. The recommended applications of a device depend on its quality grade, as indicated below. Customers must check the quality grade of each device before using it in a particular application.
 - Standard: Computers, office equipment, communications equipment, test and measurement equipment, audio and visual equipment, home electronic appliances, machine tools, personal electronic equipment and industrial robots
 - Special: Transportation equipment (automobiles, trains, ships, etc.), traffic control systems, anti-disaster systems, anti-crime systems, safety equipment and medical equipment (not specifically designed for life support)
 - Specific: Aircraft, aerospace equipment, submersible repeaters, nuclear reactor control systems, life support systems or medical equipment for life support, etc.
- The quality grade of NEC devices is "Standard" unless otherwise specified in NEC's Data Sheets or Data Books. If customers intend to use NEC devices for applications other than those specified for Standard quality grade, they should contact an NEC sales representative in advance.