



AO6400
N-Channel Enhancement Mode Field Effect Transistor

General Description

The AO6400 uses advanced trench technology to provide excellent $R_{DS(ON)}$, low gate charge and operation with gate voltages as low as 2.5V. This device is suitable for use as a load switch or in PWM applications.

Features

- V_{DS} (V) = 30V
- I_D = 6.9 A
- $R_{DS(ON)} < 28m\Omega$ ($V_{GS} = 10V$)
- $R_{DS(ON)} < 33m\Omega$ ($V_{GS} = 4.5V$)
- $R_{DS(ON)} < 52m\Omega$ ($V_{GS} = 2.5V$)

TSOP-6
Top View

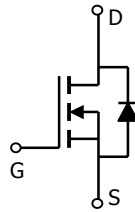
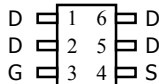

Absolute Maximum Ratings $T_A=25^\circ\text{C}$ unless otherwise noted

Parameter	Symbol	Maximum	Units
Drain-Source Voltage	V_{DS}	30	V
Gate-Source Voltage	V_{GS}	± 12	V
Continuous Drain Current ^A	I_D	$T_A=25^\circ\text{C}$	A
		$T_A=70^\circ\text{C}$	
Pulsed Drain Current ^B	I_{DM}	35	A
Power Dissipation ^A	P_D	$T_A=25^\circ\text{C}$	W
		$T_A=70^\circ\text{C}$	
Junction and Storage Temperature Range	T_J, T_{STG}	-55 to 150	$^\circ\text{C}$

Thermal Characteristics

Parameter	Symbol	Typ	Max	Units
Maximum Junction-to-Ambient ^A	$R_{\theta JA}$	47.5	62.5	$^\circ\text{C/W}$
Maximum Junction-to-Ambient ^A		Steady-State	74	
Maximum Junction-to-Lead ^C	$R_{\theta JL}$	37	50	$^\circ\text{C/W}$

Electrical Characteristics ($T_J=25^\circ\text{C}$ unless otherwise noted)

Symbol	Parameter	Conditions	Min	Typ	Max	Units
STATIC PARAMETERS						
BV_{DSS}	Drain-Source Breakdown Voltage	$I_D=250\mu\text{A}$, $V_{GS}=0\text{V}$	30			V
I_{DSS}	Zero Gate Voltage Drain Current	$V_{DS}=24\text{V}$, $V_{GS}=0\text{V}$ $T_J=55^\circ\text{C}$			1 5	μA
I_{GSS}	Gate-Body leakage current	$V_{DS}=0\text{V}$, $V_{GS}=\pm 12\text{V}$			100	nA
$V_{GS(th)}$	Gate Threshold Voltage	$V_{DS}=V_{GS}$, $I_D=250\mu\text{A}$	0.7	1.1	1.4	V
$I_{D(ON)}$	On state drain current	$V_{GS}=4.5\text{V}$, $V_{DS}=5\text{V}$	35			A
$R_{DS(ON)}$	Static Drain-Source On-Resistance	$V_{GS}=10\text{V}$, $I_D=6.9\text{A}$ $T_J=125^\circ\text{C}$		22.3 31.5	28 39	$\text{m}\Omega$
		$V_{GS}=4.5\text{V}$, $I_D=6\text{A}$		26.8	33	$\text{m}\Omega$
		$V_{GS}=2.5\text{V}$, $I_D=5\text{A}$		42.8	52	$\text{m}\Omega$
g_{FS}	Forward Transconductance	$V_{DS}=5\text{V}$, $I_D=5\text{A}$	10	15		S
V_{SD}	Diode Forward Voltage	$I_S=1\text{A}$, $V_{GS}=0\text{V}$		0.71	1	V
I_S	Maximum Body-Diode Continuous Current				3	A
DYNAMIC PARAMETERS						
C_{iss}	Input Capacitance	$V_{GS}=0\text{V}$, $V_{DS}=15\text{V}$, $f=1\text{MHz}$		823		pF
C_{oss}	Output Capacitance			99		pF
C_{rss}	Reverse Transfer Capacitance			77		pF
R_g	Gate resistance	$V_{GS}=0\text{V}$, $V_{DS}=0\text{V}$, $f=1\text{MHz}$		1.2		Ω
SWITCHING PARAMETERS						
Q_g	Total Gate Charge	$V_{GS}=4.5\text{V}$, $V_{DS}=15\text{V}$, $I_D=5.8\text{A}$		9.6		nC
Q_{gs}	Gate Source Charge			1.65		nC
Q_{gd}	Gate Drain Charge			3		nC
$t_{D(on)}$	Turn-On DelayTime	$V_{GS}=10\text{V}$, $V_{DS}=15\text{V}$, $R_L=2.7\Omega$, $R_{GEN}=6\Omega$		5.5		ns
t_r	Turn-On Rise Time			5.1		ns
$t_{D(off)}$	Turn-Off DelayTime			37		ns
t_f	Turn-Off Fall Time			4.2		ns
t_{rr}	Body Diode Reverse Recovery Time	$I_F=5\text{A}$, $dI/dt=100\text{A}/\mu\text{s}$		16		ns
Q_{rr}	Body Diode Reverse Recovery Charge	$I_F=5\text{A}$, $dI/dt=100\text{A}/\mu\text{s}$		8.9		nC

A: The value of $R_{\theta JA}$ is measured with the device mounted on 1in² FR-4 board with 2oz. Copper, in a still air environment with $T_A=25^\circ\text{C}$. The value in any a given application depends on the user's specific board design. The current rating is based on the $\leq 10\text{s}$ thermal resistance rating.

B: Repetitive rating, pulse width limited by junction temperature.

C. The $R_{\theta JA}$ is the sum of the thermal impedance from junction to lead $R_{\theta JL}$ and lead to ambient.

D. The static characteristics in Figures 1 to 6,12,14 are obtained using 80 μs pulses, duty cycle 0.5% max.

E. These tests are performed with the device mounted on 1 in² FR-4 board with 2oz. Copper, in a still air environment with $T_A=25^\circ\text{C}$. The SOA curve provides a single pulse rating.

TYPICAL ELECTRICAL AND THERMAL CHARACTERISTICS

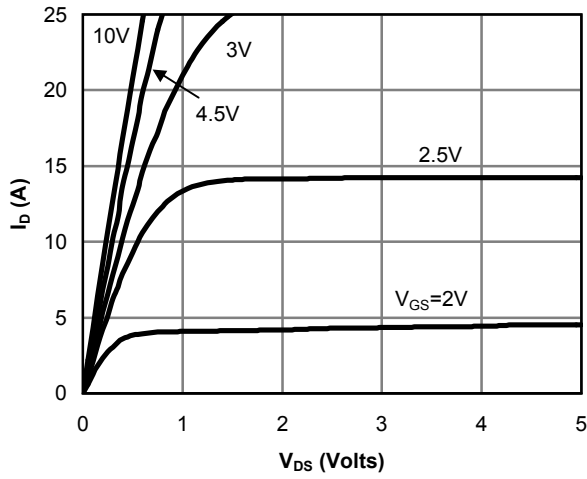

Fig 1: On-Region characteristics

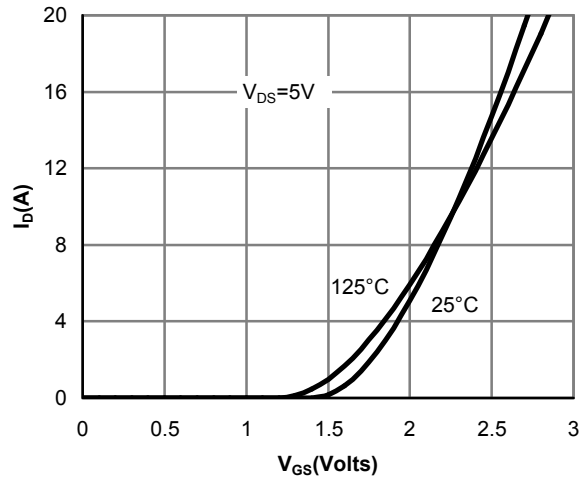

Figure 2: Transfer Characteristics

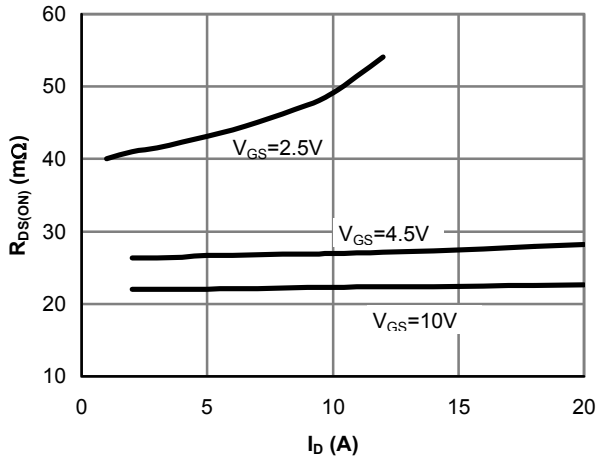

Figure 3: On-Resistance vs. Drain Current and Gate Voltage

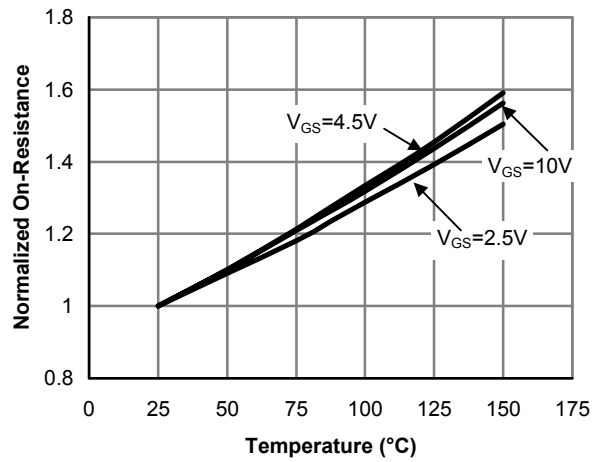

Figure 4: On-Resistance vs. Junction Temperature

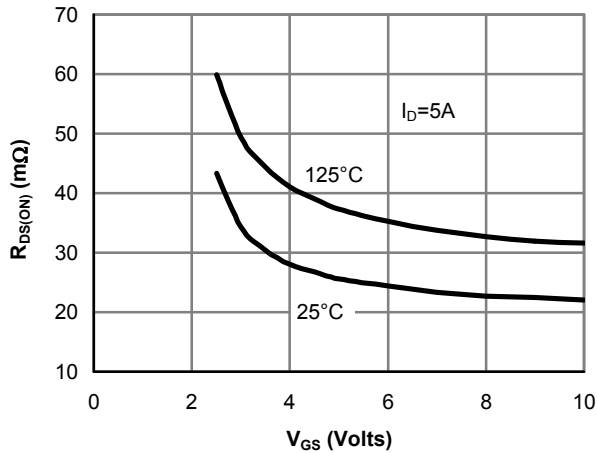

Figure 5: On-Resistance vs. Gate-Source Voltage

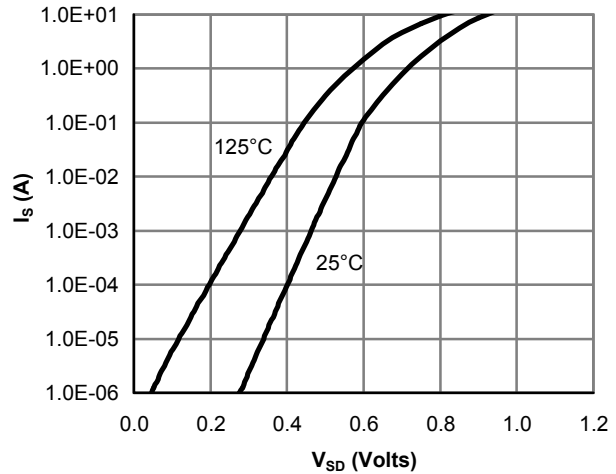

Figure 6: Body-Diode Characteristics

TYPICAL ELECTRICAL AND THERMAL CHARACTERISTICS

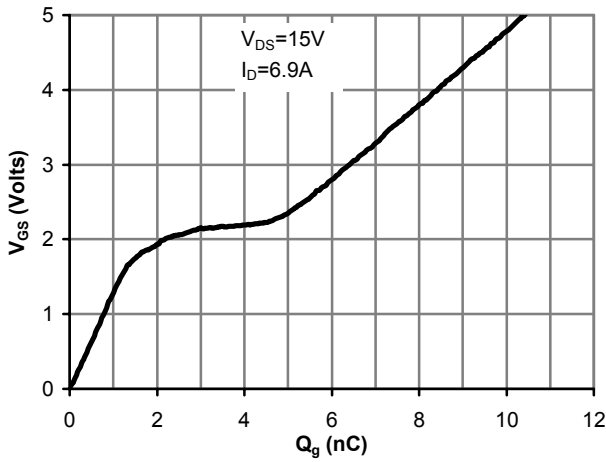

Figure 7: Gate-Charge Characteristics

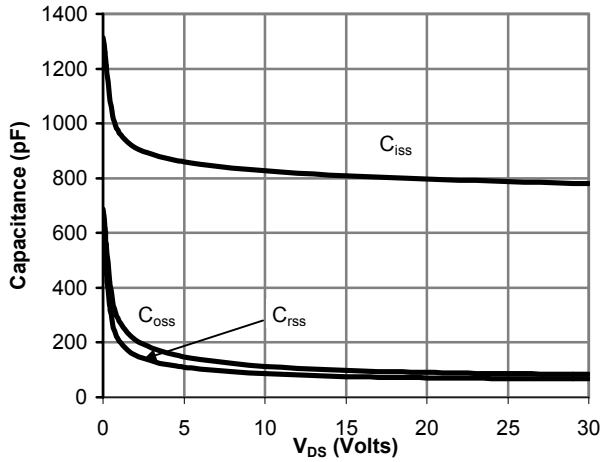

Figure 8: Capacitance Characteristics

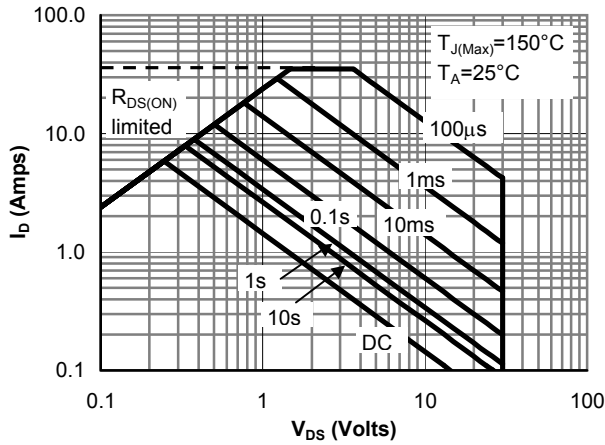

Figure 9: Maximum Forward Biased Safe Operating Area (Note E)

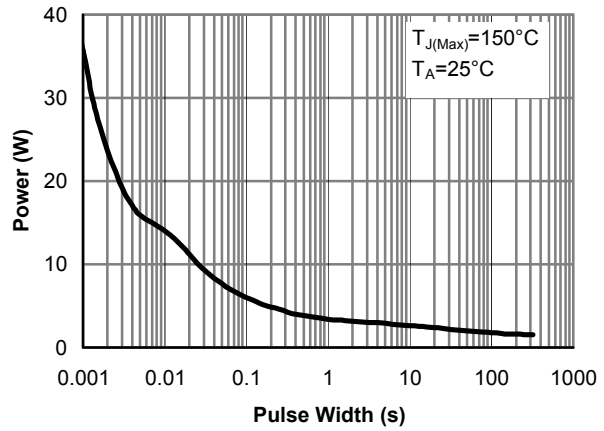

Figure 10: Single Pulse Power Rating Junction-to-Ambient (Note E)

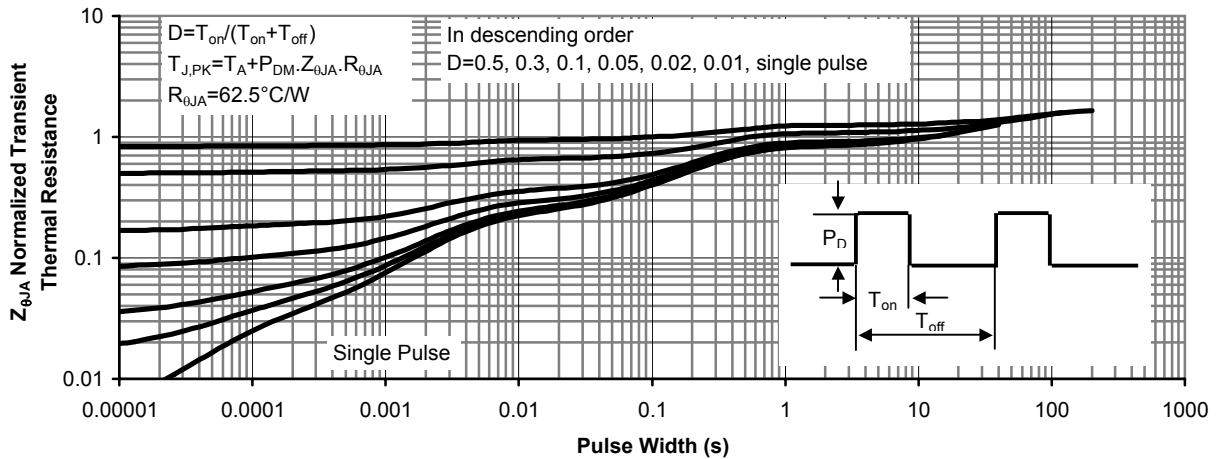
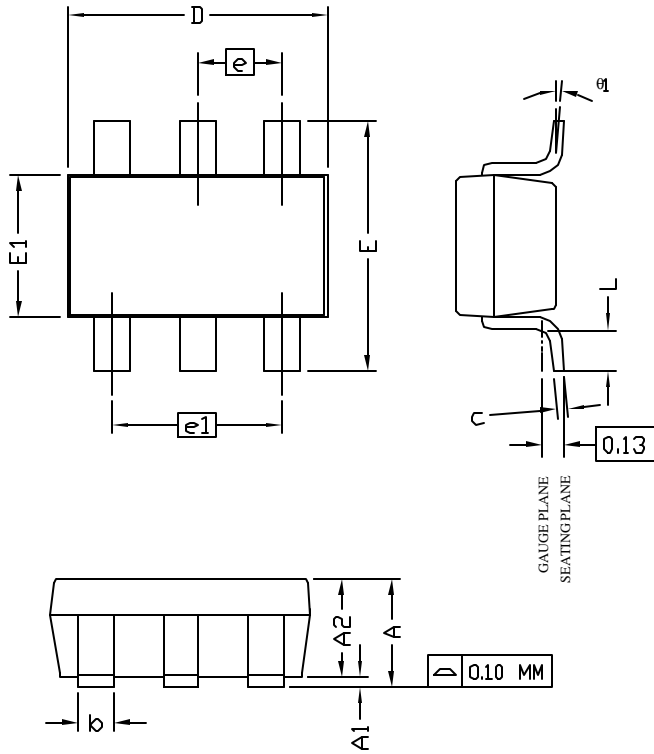

Figure 11: Normalized Maximum Transient Thermal Impedance



ALPHA & OMEGA
SEMICONDUCTOR, INC.

TSOP-6 Package Data



SYMBOLS	DIMENSIONS IN MILLIMETERS		
	MIN	NOM	MAX
A	1.00	—	1.25
A1	0.00	—	0.10
A2	1.00	1.10	1.15
b	0.35	0.40	0.50
c	0.10	0.13	0.20
D	2.70	2.90	3.10
E	2.60	2.80	3.00
E1	1.60	1.80	2.00
e	0.95 BSC		
e1	1.90 BSC		
L	0.37	—	—
$\theta 1$	1°	5°	8°

- NOTE:
- LEAD FINISH: 150 MICRONS (3.8 μ m) MIN. THICKNESS OF Tin/Lead (SOLDER) PLATED ON LEAD
 - TOLERANCE ± 0.100 mm (4 mil) UNLESS OTHERWISE SPECIFIED
 - COPLANARITY : 0.1000 mm
 - DIMENSION L IS MEASURED IN GAGE PLANE

PACKAGE MARKING DESCRIPTION

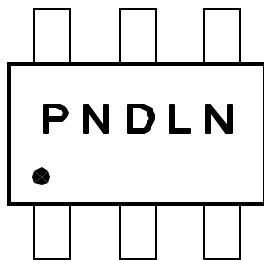

NOTE:
P N - PART NUMBER CODE.
D - YEAR AND WEEK CODE.
L N - ASSEMBLY LOT CODE, FAB AND ASSEMBLY LOCATION CODE.

TSOP-6 PART NO. CODE

PART NO.	CODE
AO6400	D0
AO6401	D1

RECOMMENDED LAND PATTERN

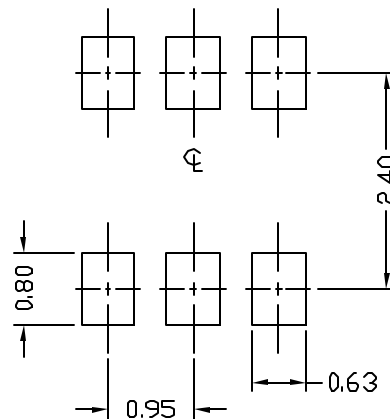



TSOP-6 Carrier Tape

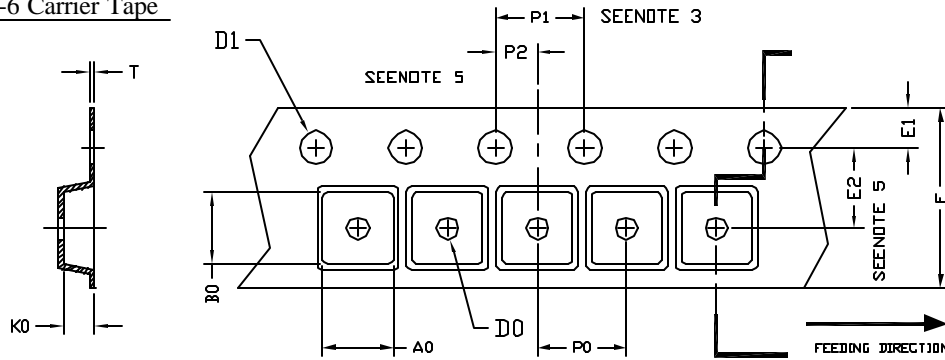

UNIT: MM

PACKAGE	A0	B0	K0	D0	D1	E	E1	E2	P0	P1	P2	T
SDT-23 (8 mm)	3.15 ±0.10	3.27 ±0.10	1.34 ±0.10	1.10 ±0.01	1.30 ±0.10	8.00 ±0.20	1.75 ±0.10	3.50 ±0.05	4.00 ±0.10	4.00 ±0.10	2.00 ±0.10	0.25 ±0.05

TSOP-6 Reel

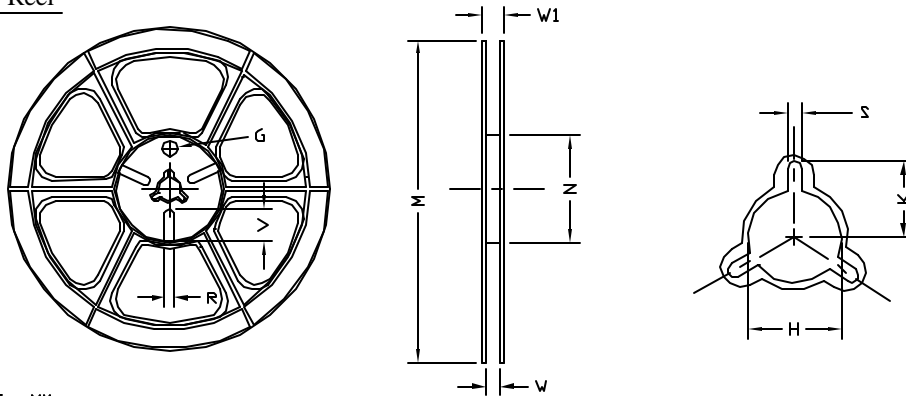

UNIT: MM

TAPE SIZE	REEL SIZE	M	N	W	W1	H	K	S	G	R	V
8 mm	φ180	φ180.00 ±0.50	φ60.50	9.00 ±0.30	11.40 ±1.00	φ13.00 +0.50 -0.20	10.60	2.00 ±0.50	φ9.00	5.00	18.00

TSOP-6 Tape

Leader / Trailer
& Orientation

