

3SK318

Silicon N-Channel Dual Gate MOS FET
UHF RF Amplifier

HITACHI

ADE-208-600(Z)
1st. Edition
February 1998

Features

- Low noise characteristics;
(NF= 1.4 dB typ. at f= 900 MHz)
- Excellent cross modulation characteristics
- Capable low voltage operation; +B= 5V

Outline

CMPAK-4

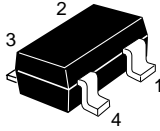

1. Source
2. Gate1
3. Gate2
4. Drain

Note: Marking is "YB-".

Absolute Maximum Ratings (Ta = 25°C)

Item	Symbol	Ratings	Unit
Drain to source voltage	V_{DS}	6	V
Gate1 to source voltage	V_{G1S}	±6	V
Gate2 to source voltage	V_{G2S}	±6	V
Drain current	I_D	20	mA
Channel power dissipation	Pch	100	mW
Channel temperature	Tch	150	°C
Storage temperature	Tstg	-55 to +150	°C

Electrical Characteristics (Ta = 25°C)

Item	Symbol	Min	Typ	Max	Unit	Test Conditions
Drain to source breakdown voltage	$V_{(BR)DSS}$	6	—	—	V	$I_D = 200\mu A, V_{G1S} = V_{G2S} = 0$
Gate1 to source breakdown voltage	$V_{(BR)G1SS}$	±6	—	—	V	$I_{G1} = \pm 10\mu A, V_{G2S} = V_{DS} = 0$
Gate2 to source breakdown voltage	$V_{(BR)G2SS}$	±6	—	—	V	$I_{G2} = \pm 10\mu A, V_{G1S} = V_{DS} = 0$
Gate1 to source cutoff current	I_{G1SS}	—	—	±100	nA	$V_{G1S} = \pm 5V, V_{G2S} = V_{DS} = 0$
Gate2 to source cutoff current	I_{G2SS}	—	—	±100	nA	$V_{G2S} = \pm 5V, V_{G1S} = V_{DS} = 0$
Gate1 to source cutoff voltage	$V_{G1S(off)}$	0.5	0.7	1.0	V	$V_{DS} = 5V, V_{G2S} = 3V$ $I_D = 100\mu A$
Gate2 to source cutoff voltage	$V_{G2S(off)}$	0.5	0.7	1.0	V	$V_{DS} = 5V, V_{G1S} = 3V$ $I_D = 100\mu A$
Drain current	$I_{DS(op)}$	0.5	4	10	mA	$V_{DS} = 3.5V, V_{G1S} = 1.1V$ $V_{G2S} = 3V$
Forward transfer admittance	$ y_{fs} $	18	24	32	mS	$V_{DS} = 3.5V, V_{G2S} = 3V$ $I_D = 10mA, f = 1kHz$
Input capacitance	C_{iss}	1.3	1.6	1.9	pF	$V_{DS} = 3.5V, V_{G2S} = 3V$
Output capacitance	C_{oss}	0.9	1.2	1.5	pF	$I_D = 10mA, f = 1MHz$
Reverse transfer capacitance	C_{rss}	—	0.019	0.03	pF	
Power gain	PG	18	21	—	dB	$V_{DS} = 3.5V, V_{G2S} = 3V$
Noise figure	NF	—	1.4	2.2	dB	$I_D = 10mA, f = 900MHz$

Maximum Channel Power Dissipation Curve

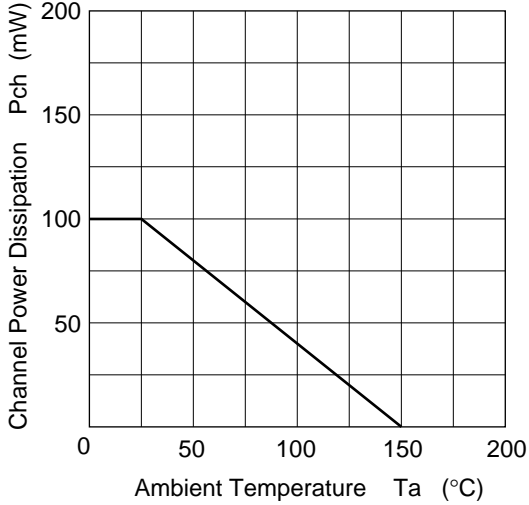

Typical Output Characteristics

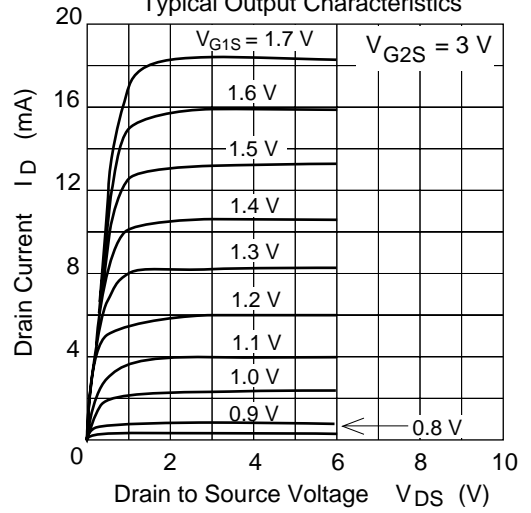

Drain Current vs. Gate1 to Source Voltage

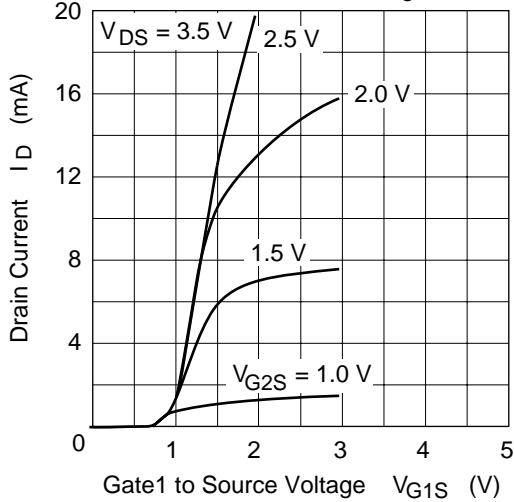

Drain Current vs. Gate2 to Source Voltage

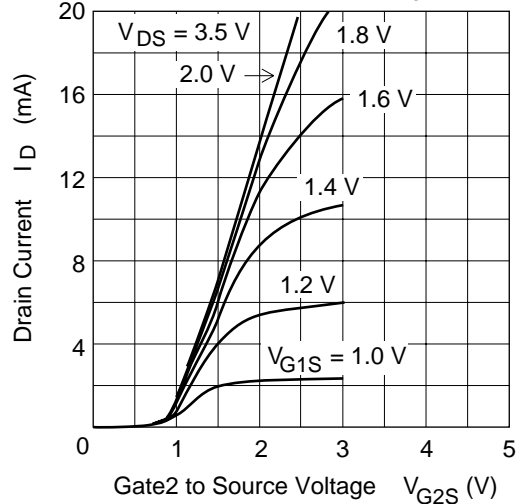

Forward Transfer Admittance vs. Gate1 Voltage

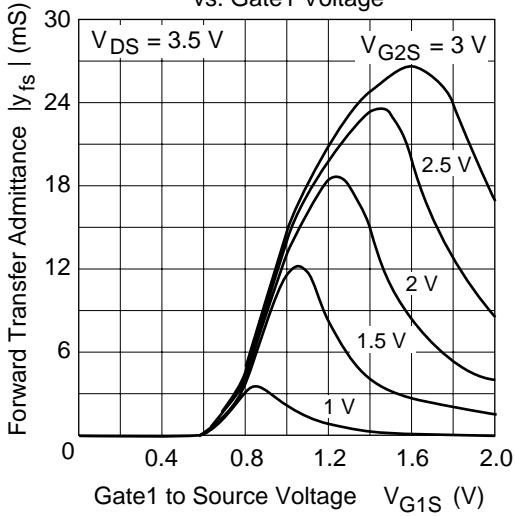

Power Gain vs. Drain Current

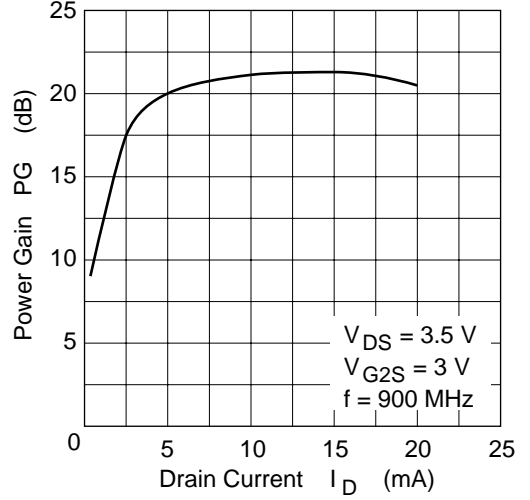

Noise Figure vs. Drain Current

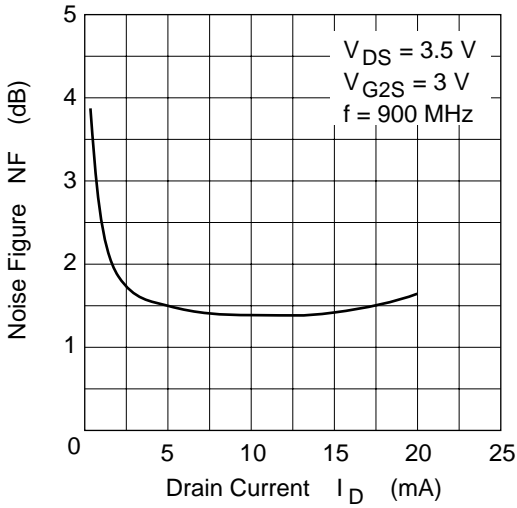

Power Gain vs. Drain to Source Voltage

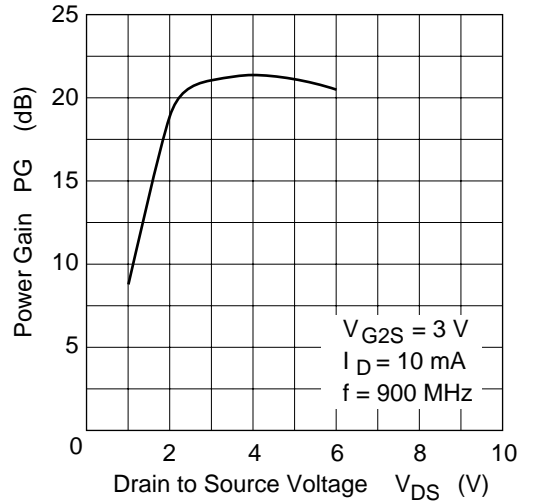

Noise Figure vs. Drain to Source Voltage

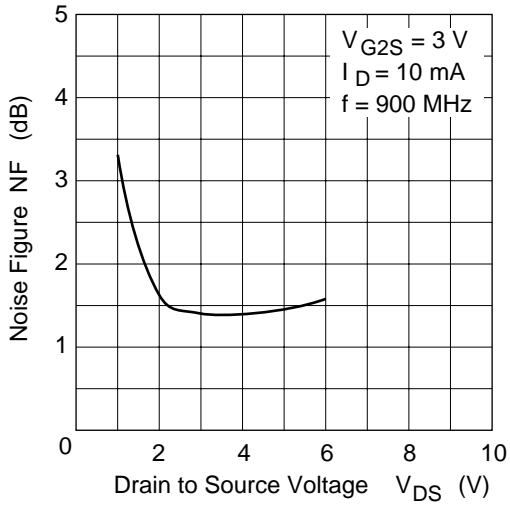

Power Gain vs. Gate2 to Source Voltage

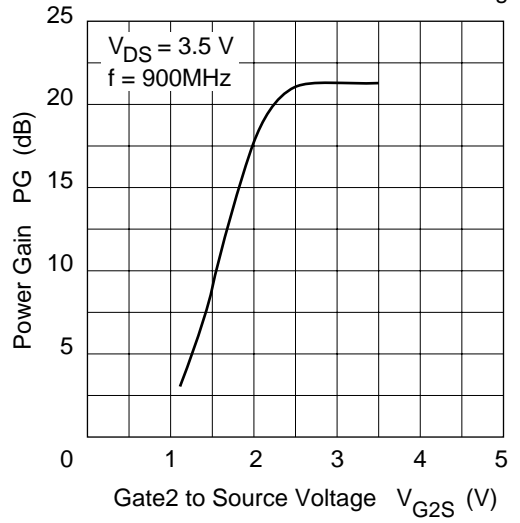

Noise Figure vs. Gate2 to Source Voltage

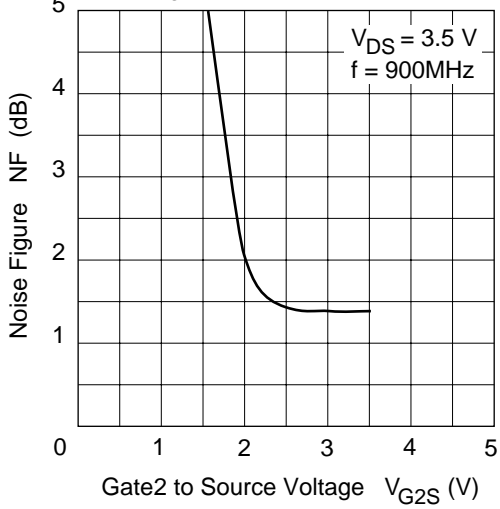

S11 Parameter vs. Frequency

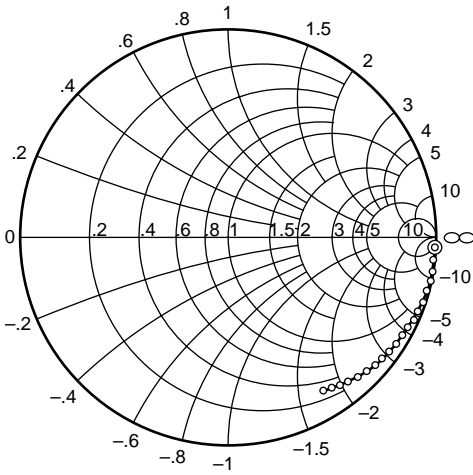

Test Condition : $V_{DS} = 3.5\text{ V}$, $V_{G2S} = 3\text{ V}$
 $I_D = 10\text{ mA}$
 50 to 1000 MHz (50 MHz step)



S21 Parameter vs. Frequency

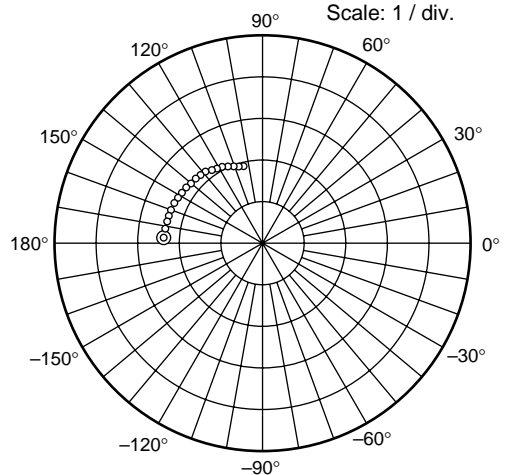

Test Condition : $V_{DS} = 3.5\text{ V}$, $V_{G2S} = 3\text{ V}$
 $I_D = 10\text{ mA}$
 50 to 1000 MHz (50 MHz step)



S12 Parameter vs. Frequency

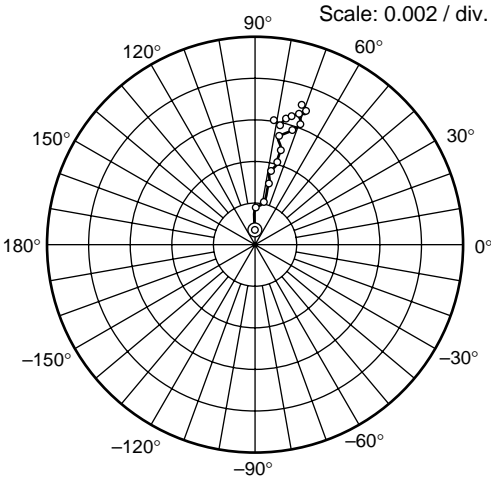

Test Condition : $V_{DS} = 3.5\text{ V}$, $V_{G2S} = 3\text{ V}$
 $I_D = 10\text{ mA}$
 50 to 1000 MHz (50 MHz step)



S22 Parameter vs. Frequency

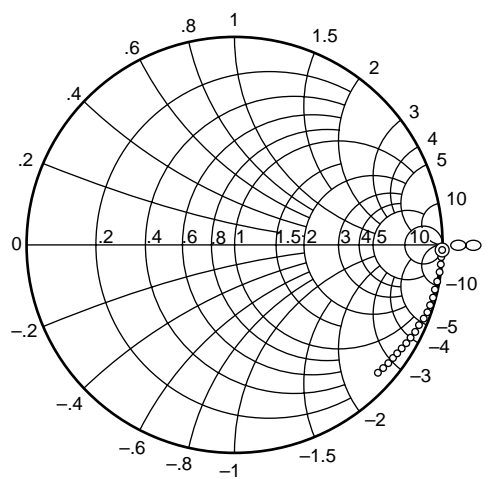

Test Condition : $V_{DS} = 3.5\text{ V}$, $V_{G2S} = 3\text{ V}$
 $I_D = 10\text{ mA}$
 50 to 1000 MHz (50 MHz step)



Sparameter ($V_{DS} = 3.5V$, $V_{G2S} = 3V$, $I_D = 10mA$, $Z_o = 50\Omega$)

f (MHz)	S11		S21		S12		S22	
	MAG	ANG	MAG	ANG	MAG	ANG	MAG	ANG
50	1.000	-2.8	2.41	176.3	0.00068	89.1	0.999	-2.2
100	0.998	-5.8	2.41	171.9	0.00176	88.5	0.996	-4.5
150	0.997	-9.1	2.39	167.6	0.00223	80.7	0.996	-6.7
200	0.994	-12.2	2.38	163.7	0.00303	76.6	0.994	-8.7
250	0.994	-15.1	2.37	159.8	0.00365	79.1	0.991	-11.0
300	0.986	-18.5	2.35	155.5	0.00414	75.4	0.988	-13.2
350	0.978	-21.3	2.30	151.4	0.00484	75.0	0.983	-15.3
400	0.972	-24.1	2.28	147.6	0.00533	78.0	0.980	-17.4
450	0.969	-27.0	2.26	143.6	0.00588	71.6	0.976	-19.6
500	0.954	-29.7	2.23	140.0	0.00617	69.5	0.971	-21.7
550	0.955	-32.8	2.19	135.9	0.00666	71.5	0.966	-23.7
600	0.941	-35.7	2.17	132.2	0.00672	70.6	0.960	-25.6
650	0.932	-38.3	2.14	128.6	0.00694	69.0	0.955	-27.8
700	0.924	-41.3	2.09	125.0	0.00709	71.4	0.948	-29.9
750	0.919	-44.1	2.07	121.5	0.00689	69.0	0.942	-31.8
800	0.905	-46.9	2.03	117.9	0.00699	68.9	0.937	-33.8
850	0.896	-49.2	2.00	114.7	0.00644	74.2	0.930	-35.8
900	0.884	-52.4	1.96	110.4	0.00633	75.5	0.923	-37.6
950	0.880	-54.7	1.93	107.1	0.00585	77.8	0.917	-39.8
1000	0.866	-57.7	1.89	103.8	0.00605	82.1	0.910	-41.9

Package Dimensions

Unit: mm

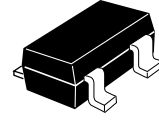
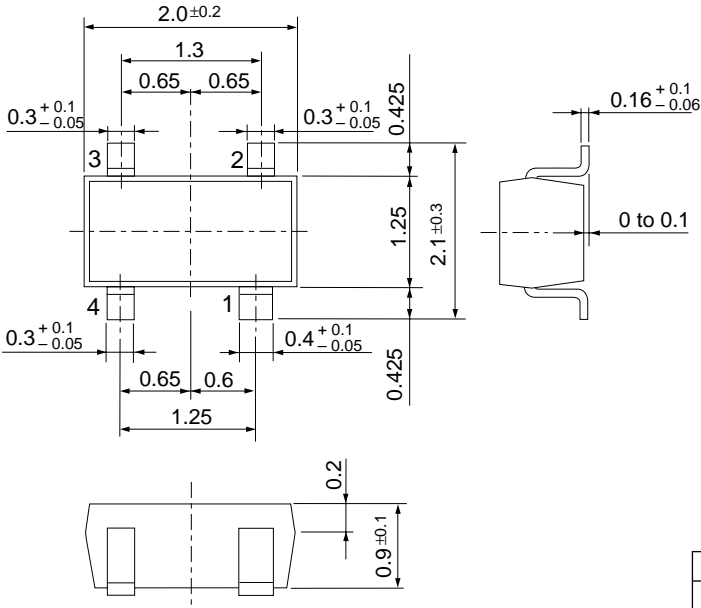

Hitachi Code	CMPAK-4
EIAJ	SC-82AB
JEDEC	—

Cautions

1. Hitachi neither warrants nor grants licenses of any rights of Hitachi's or any third party's patent, copyright, trademark, or other intellectual property rights for information contained in this document. Hitachi bears no responsibility for problems that may arise with third party's rights, including intellectual property rights, in connection with use of the information contained in this document.
2. Products and product specifications may be subject to change without notice. Confirm that you have received the latest product standards or specifications before final design, purchase or use.
3. Hitachi makes every attempt to ensure that its products are of high quality and reliability. However, contact Hitachi's sales office before using the product in an application that demands especially high quality and reliability or where its failure or malfunction may directly threaten human life or cause risk of bodily injury, such as aerospace, aeronautics, nuclear power, combustion control, transportation, traffic, safety equipment or medical equipment for life support.
4. Design your application so that the product is used within the ranges guaranteed by Hitachi particularly for maximum rating, operating supply voltage range, heat radiation characteristics, installation conditions and other characteristics. Hitachi bears no responsibility for failure or damage when used beyond the guaranteed ranges. Even within the guaranteed ranges, consider normally foreseeable failure rates or failure modes in semiconductor devices and employ systemic measures such as fail-safes, so that the equipment incorporating Hitachi product does not cause bodily injury, fire or other consequential damage due to operation of the Hitachi product.
5. This product is not designed to be radiation resistant.
6. No one is permitted to reproduce or duplicate, in any form, the whole or part of this document without written approval from Hitachi.
7. Contact Hitachi's sales office for any questions regarding this document or Hitachi semiconductor products.

HITACHI

Hitachi, Ltd.

Semiconductor & Integrated Circuits.
Nippon Bldg., 2-6-2, Ohte-machi, Chiyoda-ku, Tokyo 100-0004, Japan
Tel: Tokyo (03) 3270-2111 Fax: (03) 3270-5109

URL North America : <http://semiconductor.hitachi.com/>
 Europe : <http://www.hitachi-eu.com/hel/ecg>
 Asia (Singapore) : <http://www.has.hitachi.com.sg/grp3/sicd/index.htm>
 Asia (Taiwan) : http://www.hitachi.com.tw/E/Product/SICD_Frame.htm
 Asia (HongKong) : <http://www.hitachi.com.hk/eng/bo/grp3/index.htm>
 Japan : <http://www.hitachi.co.jp/Sicd/indx.htm>

For further information write to:

Hitachi Semiconductor
(America) Inc.
179 East Tasman Drive,
San Jose, CA 95134
Tel: <1> (408) 433-1990
Fax: <1> (408) 433-0223

Hitachi Europe GmbH
Electronic components Group
Dornacher Straße 3
D-85622 Feldkirchen, Munich
Germany
Tel: <49> (89) 9 9180-0
Fax: <49> (89) 9 29 30 00

Hitachi Europe Ltd.
Electronic Components Group.
Whitebrook Park
Lower Cookham Road
Maidenhead
Berkshire SL6 8YA, United Kingdom
Tel: <44> (1628) 585000
Fax: <44> (1628) 778322

Hitachi Asia Pte. Ltd.
16 Collyer Quay #20-00
Hitachi Tower
Singapore 049318
Tel: 535-2100
Fax: 535-1533

Hitachi Asia Ltd.
Taipei Branch Office
3F, Hung Kuo Building, No.167,
Tun-Hwa North Road, Taipei (105)
Tel: <886> (2) 2718-3666
Fax: <886> (2) 2718-8180

Hitachi Asia (Hong Kong) Ltd.
Group III (Electronic Components)
7/F., North Tower, World Finance Centre,
Harbour City, Canton Road, Tsim Sha Tsui,
Kowloon, Hong Kong
Tel: <852> (2) 735 9218
Fax: <852> (2) 730 0281
Telex: 40815 HITEC HX

Copyright ' Hitachi, Ltd., 1999. All rights reserved. Printed in Japan.

HITACHI