

GM3055 N-CHANNEL ENHANCEMENT MODE POWER MOSFET

Description

The SOT-89 package is universally preferred for all commercial industrial surface mount applications and suited for low voltage applications such as DC/DC converters.

Package Dimensions

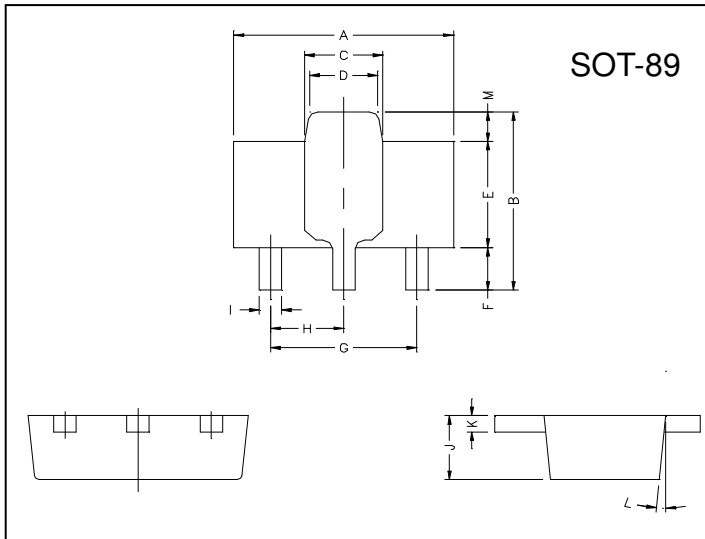

Marking :

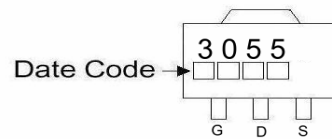

REF.	Millimeter		REF.	Millimeter	
	Min.	Max.		Min.	Max.
A	4.4	4.6	G	3.00	REF.
B	4.05	4.25	H	1.50	REF.
C	1.50	1.70	I	0.40	0.52
D	1.30	1.50	J	1.40	1.60
E	2.40	2.60	K	0.35	0.41
F	0.89	1.20	L	5° TYP.	
			M	0.70 REF.	

Absolute Maximum Ratings at Ta = 25°C

Parameter	Symbol	Ratings	Unit
Operating Junction Temperature Range	Tj	-55 ~ +150	°C
Storage Temperature Range	Tstg	-55 ~ +150	°C
Drain - Source Voltage	Vds	30	V
Gate - Source Voltage	Vgs	±20	V
Continuous Drain Current ,VGS@10V	Id@TC=25°C	15	A
Continuous Drain Current ,VGS@10V	Id@TC=100°C	9	A
Pulsed Drain Current ¹	IdM	50	A
Total Power Dissipation	Pd@TC=25°C	15	W

Thermal Data

Symbol	parameter	Value	Unit
Rthj-case	Thermal Resistance junction-case Max.	3	°C/W
Rthj-amb	Thermal Resistance junction-ambient Max.	42	°C/W

Source - Drain Diode

Symbol	Parameter	Test Conditions	Min.	Typ.	Max.	Units
Is	Continuous source Current (Body Diode)	Vd=Vg=0V, Vs=1.3V	-	-	15	A
ISM	Pulsed Source Current(Body Diode) ¹		-	-	50	A
Vsd	Forward On Voltage ²	Tj=25°C, Is=15A, Vgs=0V	-	-	1.3	V

Notes:

1. Pulse width limited by safe operating area.
2. Pulse width $\leq 300\mu\text{s}$, duty cycle $\leq 2\%$.

Electrical Characteristics @T_j = 25°C (unless otherwise specified)

Symbol	Parameter	Test Conditions	Min.	Typ.	Max.	Unit
BV _{bss}	Drain – Source Breakdown Voltage	V _{GS} =0V, I _D =250 μ A	30	-	-	V
Δ BV _{bss} / Δ T _j	Breakdown Voltage Temperature Coefficient	Reference to 25°C, I _D =1mA	-	0.037	-	V/°C
R _{DS(ON)}	Static Drain-Source On-Resistance	V _{GS} =10V, I _D =8A	-	-	80	m Ω
		V _{GS} =4.5V, I _D =6A	-	-	100	m Ω
V _{GS(th)}	Gate Threshold Voltage	V _{DS} =V _{GS} , I _D =250 μ A	1	-	3	V
I _{DSS}	Drain-Source Leakage Current (T _j =25°C)	V _{DS} =30V, V _{GS} =0V	-	-	25	μ A
	Drain-Source Leakage Current (T _j =150°C)	V _{DS} =24V, V _{GS} =0V	-	-	250	μ A
I _{GSS}	Gate-Source Leakage	V _{GS} = \pm 20V	-	-	\pm 100	nA
Q _g	Total Gate Charge ²	I _D =8A	-	5.4	-	nC
Q _{gs}	Gate-Source Charge	V _{DS} =24V	-	1.3	-	nC
Q _{gd}	Gate-Drain ("Miller)Charge	V _{GS} =5V	-	3.6	-	nC
t _{d(on)}	Turn-on Delay Time ²	V _{DS} =15V	-	3.6	-	nS
t _r	Rise Time	I _D =8A	-	19.8	-	nS
t _{d(off)}	Turn-off Delay Time	R _G =3.4 Ω , V _{GS} =10V	-	13	-	nS
t _f	Fall Time	R _D =1.9 Ω	-	3.2	-	nS
C _{iss}	Input Capacitance	V _{GS} =0V	-	260	-	pf
C _{oss}	Output Capacitance	V _{DS} =25V	-	144	-	pf
C _{rss}	Reverse Transfer Capacitance	f=1.0MHZ	-	13	-	pf

Characteristics Curve

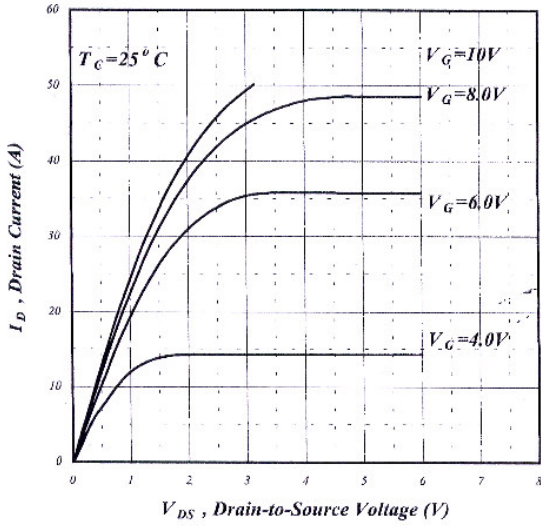

Fig 1. Typical Output Characteristics

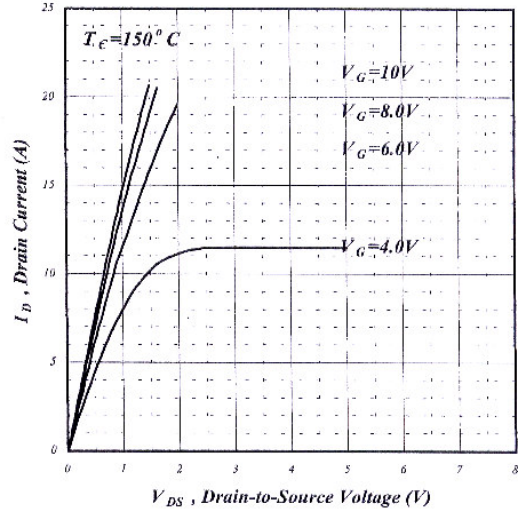

Fig 2. Typical Output Characteristics

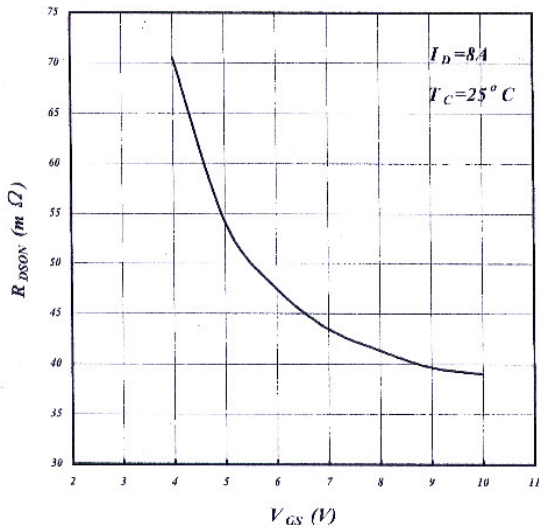

Fig 3. On-Resistance v.s. Gate Voltage

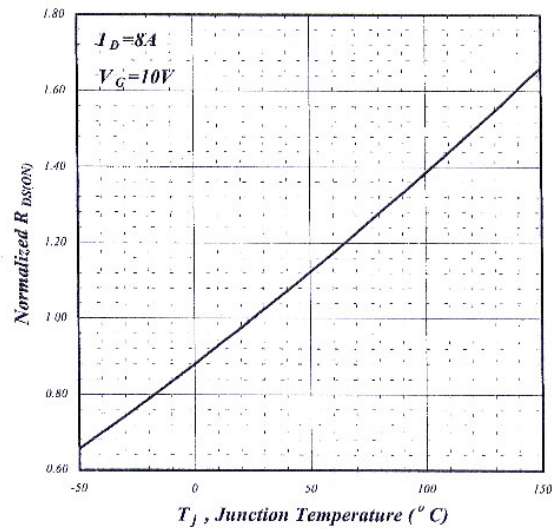

Fig 4. Normalized On-Resistance v.s. Junction Temperature

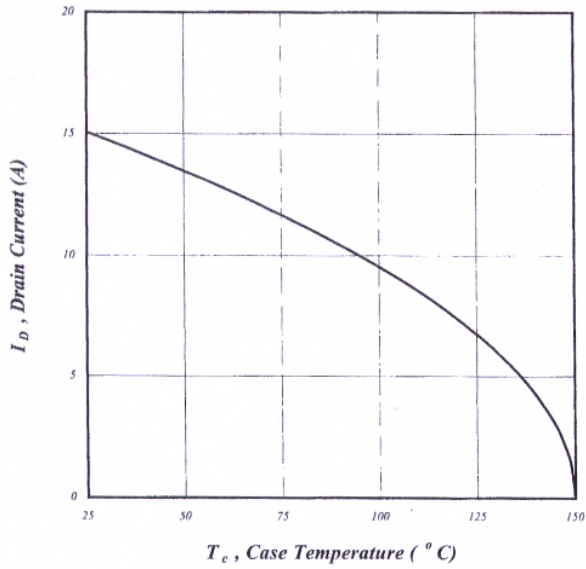

Fig 5. Maximum Drain Current v.s. Case Temperature

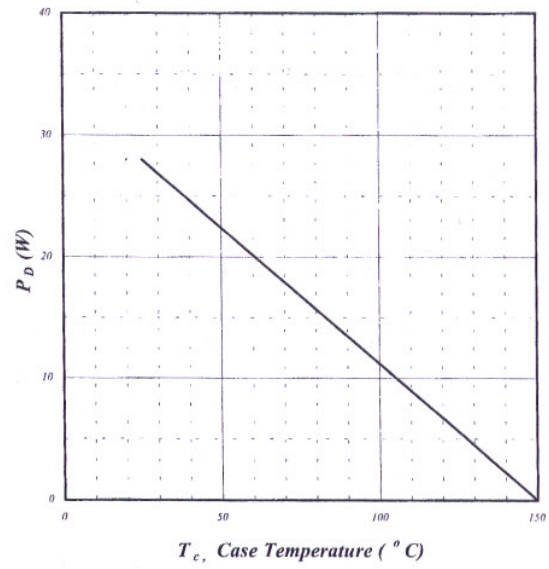

Fig 6. Typical Power Dissipation

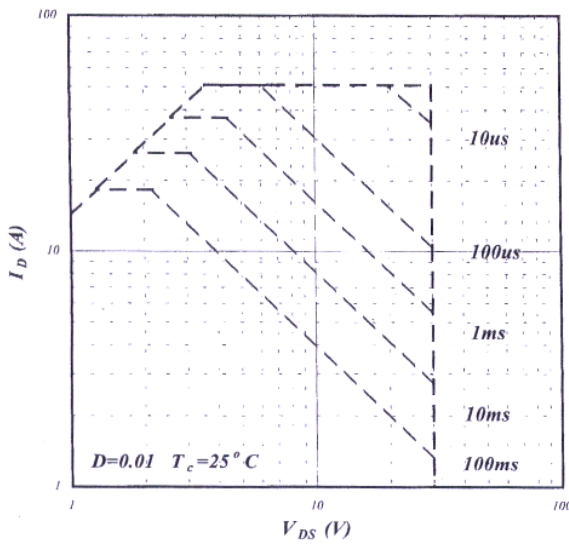

Fig 7. Maximum Safe Operating Area

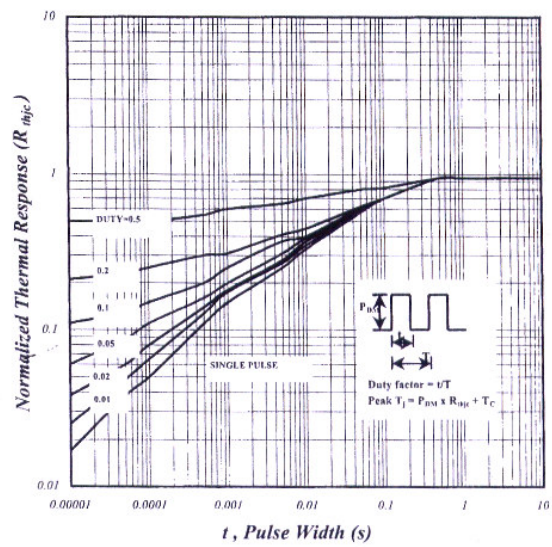
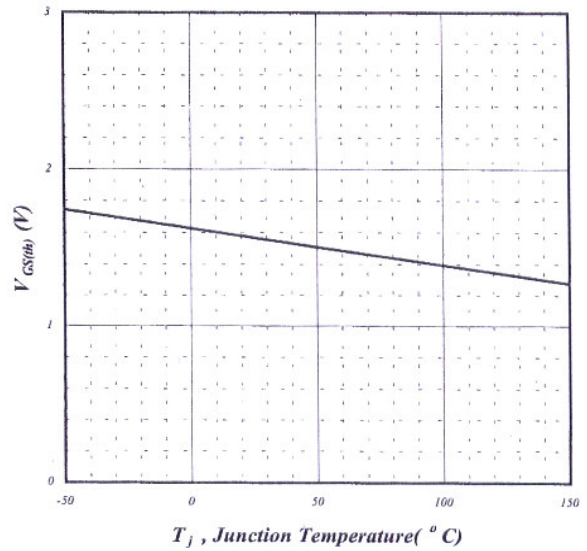
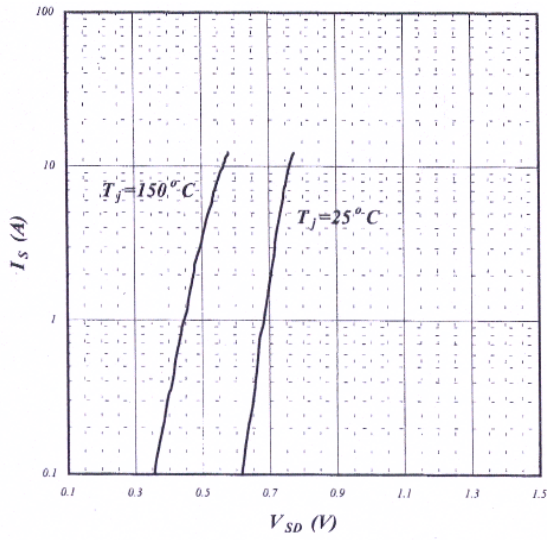
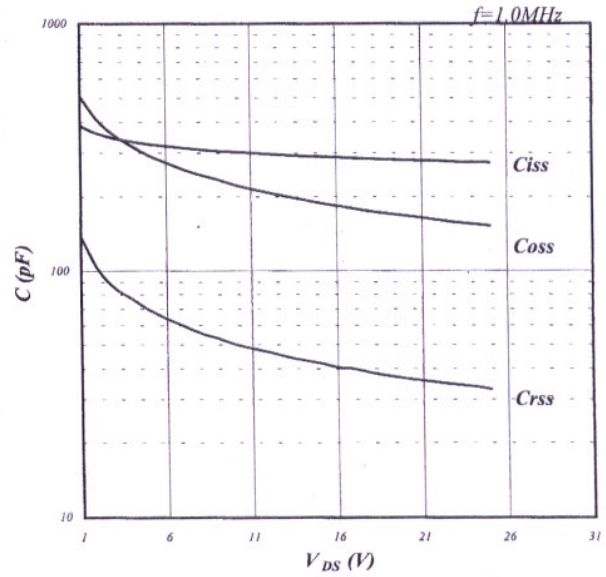
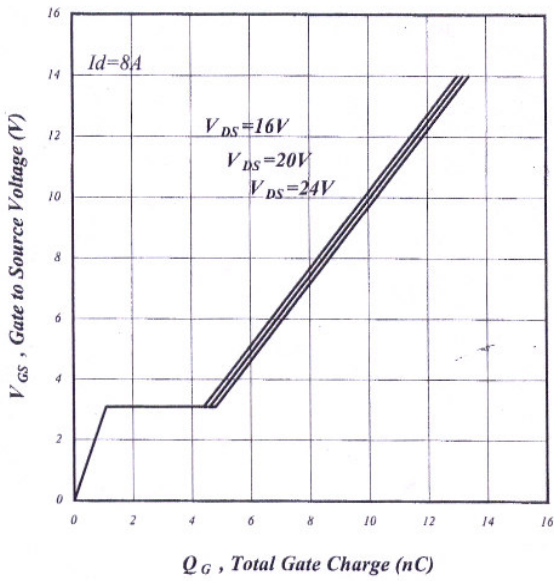

Fig 8. Effective Transient Thermal Impedance



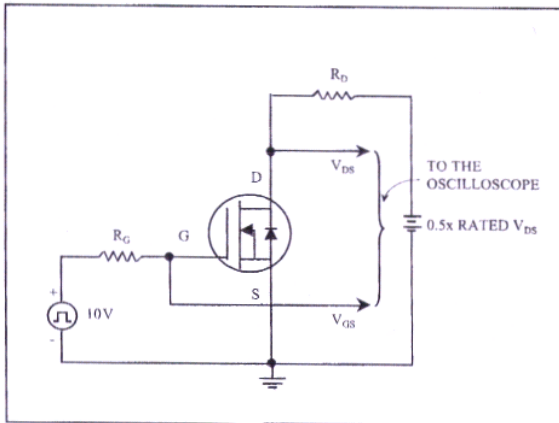

Fig 13. Switching Time Circuit

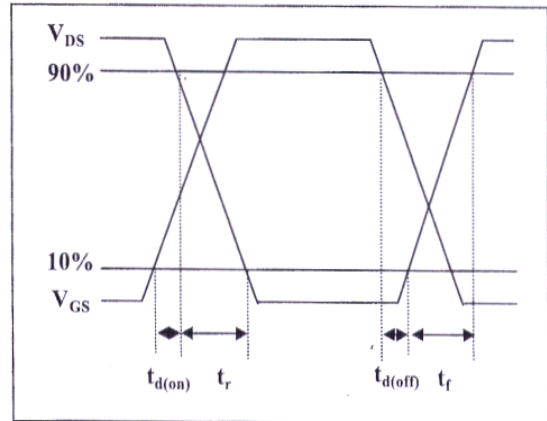

Fig 14. Switching Time Waveform

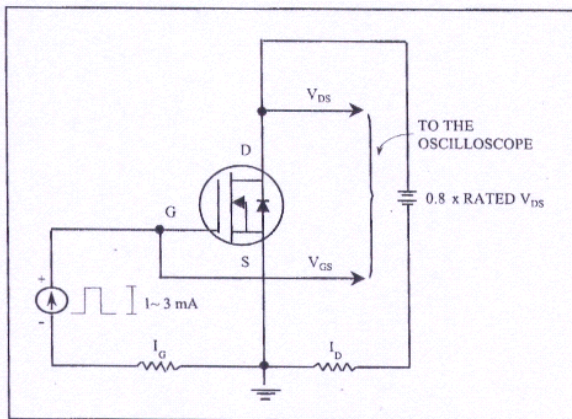

Fig 15. Gate Charge Circuit

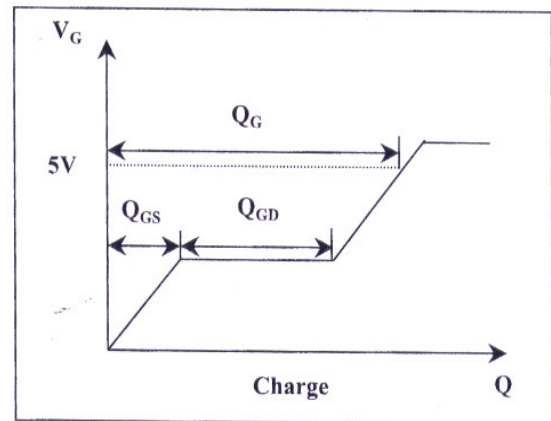

Fig 16. Gate Charge Waveform

Important Notice:

- All rights are reserved. Reproduction in whole or in part is prohibited without the prior written approval of GTM.
- GTM reserves the right to make changes to its products without notice.
- GTM semiconductor products are not warranted to be suitable for use in life-support Applications, or systems.
- GTM assumes no liability for any consequence of customer product design, infringement of patents, or application assistance.

Head Office And Factory:

- **Taiwan:** No. 17-1 Tatung Rd. Fu Kou Hsin-Chu Industrial Park, Hsin-Chu, Taiwan, R. O. C.
TEL : 886-3-597-7061 FAX : 886-3-597-9220, 597-0785
- **China:** (201203) No.255, Jang-Jiang Tsai-Lueng RD. , Pu-Dung-Hsin District, Shang-Hai City, China
TEL : 86-21-5895-7671 ~ 4 FAX : 86-21-38950165