

# AN8000/AN8000M Series

## 3-pin Positive Output Low Dropout Voltage Regulator (50mA Type)

### Overview

The AN8000 series is 3-pin low-dropout fixed positive output monolithic voltage regulators. Since their power consumption can be minimized, they are suitable for battery stabilizing power supply and reference voltage. Thirteen types of output voltage are available ; 2V, 2.5V, 3V, 3.5V (TO-92 only) , 4V, 4.5V, 5V, 6V, 7V, 8V, 8.5V, 9V, and 10V.

### Features

- Input/output voltage difference : 0.3V (max.)
- Output current of up to 50mA
- Low bias current ; 0.6mA (typ.)
- Output voltage ; 2V, 2.5V, 3V, 3.5V (TO-92 only) , 4V, 4.5V, 5V, 6V, 7V, 8V, 8.5V, 9V, and 10V.
- Over-voltage protective circuit built-in.

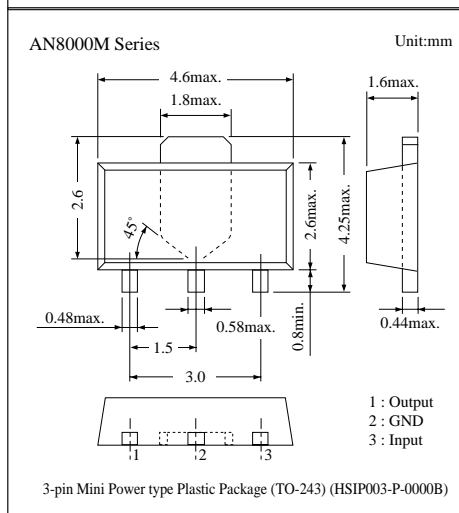
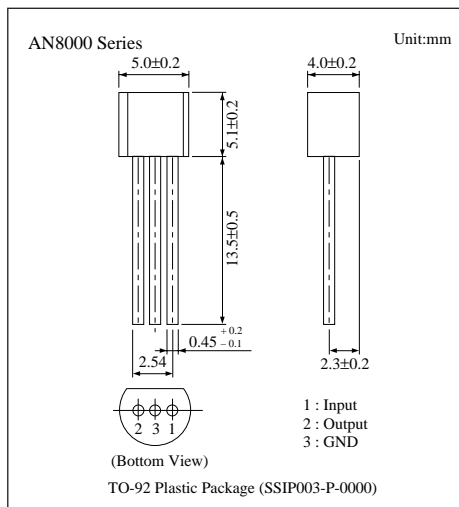

### Block Diagram

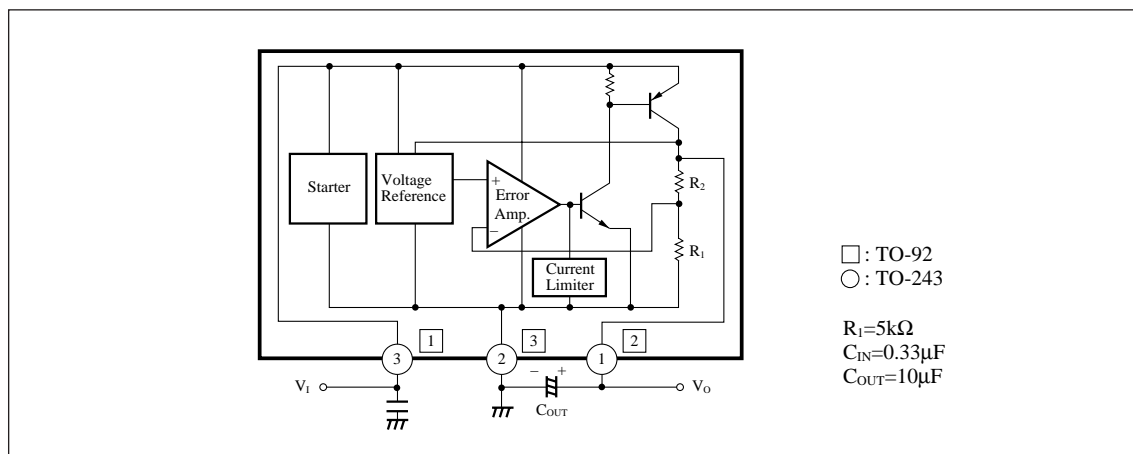

## ■ Absolute Maximum Ratings (Ta=25°C)

Parameter	Symbol	Rating	Unit
Supply voltage	$V_I$	20	V
Supply current	$I_{CC}$	100	mA
Power dissipation	$P_D$	650 *	mW
Operating ambient temperature	$T_{opr}$	-30 to+80	°C
Storage temperature	AN8000 Series	-55 to+150	°C
	AN8000M Series	-55 to+125	

\* Mounting onto the PCB (20 × 20 × 1.7mm glass epoxy copper foil 1 cm<sup>2</sup> or more), for AN8000M Series.

## ■ Electrical Characteristics (Ta=25°C)

### • AN8002/AN8002M (2V Type)

Parameter	Symbol	Condition	min	typ	max	Unit
Output voltage	$V_O$	$T_j=25^\circ\text{C}$	1.92	2	2.08	V
Line regulation	$REG_{IN}$	$V_I=2.5$ to 8V, $T_j=25^\circ\text{C}$	—	2	40	mV
Load regulation	$REG_L$	$I_O=1$ to 40mA, $T_j=25^\circ\text{C}$	—	7	20	mV
		$I_O=1$ to 50mA, $T_j=25^\circ\text{C}$	—	10	25	mV
Minimum I/O voltage difference	$V_{DIF (min.)}$	$V_I=1.9\text{V}$ , $I_O=20\text{mA}$ , $T_j=25^\circ\text{C}$	—	0.06	0.2	V
		$V_I=1.9\text{V}$ , $I_O=50\text{mA}$ , $T_j=25^\circ\text{C}$	—	0.12	0.3	V
Bias current	$I_{bias}$	$I_O=0\text{mA}$ , $T_j=25^\circ\text{C}$	—	0.6	1	mA
Ripple rejection ratio	RR	$V_I=3$ to 5V, $f=120\text{Hz}$	62	74	—	dB
Output noise voltage	$V_{no}$	$f=10\text{Hz}$ to 100kHz	—	60	—	μV
Output voltage temperature coefficient	$\Delta V_O/T_a$	$T_j=-30$ to+125°C	—	0.1	—	mV/°C

Note1) The specified condition  $T_j=25^\circ\text{C}$  means that the test should be conducted with each test time reduced (within 10ms) so that the drift in characteristic value due to a temperature rise at chip junction can be ignored.

Note2) Unless otherwise specified,  $V_I=3\text{V}$ ,  $I_O=20\text{mA}$ ,  $C_O=10\mu\text{F}$

### • AN8025/AN8025M (2.5V Type)

Parameter	Symbol	Condition	min	typ	max	Unit
Output voltage	$V_O$	$T_j=25^\circ\text{C}$	2.4	2.5	2.6	V
Line regulation	$REG_{IN}$	$V_I=3$ to 8.5V, $T_j=25^\circ\text{C}$	—	2.5	50	mV
Load regulation	$REG_L$	$I_O=1$ to 40mA, $T_j=25^\circ\text{C}$	—	8	20	mV
		$I_O=1$ to 50mA, $T_j=25^\circ\text{C}$	—	12.5	25	mV
Minimum I/O voltage difference	$V_{DIF (min.)}$	$V_I=2.4\text{V}$ , $I_O=20\text{mA}$ , $T_j=25^\circ\text{C}$	—	0.07	0.2	V
		$V_I=2.4\text{V}$ , $I_O=50\text{mA}$ , $T_j=25^\circ\text{C}$	—	0.12	0.3	V
Bias current	$I_{bias}$	$I_O=0\text{mA}$ , $T_j=25^\circ\text{C}$	—	0.6	1	mA
Ripple rejection ratio	RR	$V_I=3.5$ to 5.5V, $f=120\text{Hz}$	60	72	—	dB
Output noise voltage	$V_{no}$	$f=10\text{Hz}$ to 100kHz	—	65	—	μV
Output voltage temperature coefficient	$\Delta V_O/T_a$	$T_j=-30$ to+125°C	—	0.13	—	mV/°C

Note1) The specified condition  $T_j=25^\circ\text{C}$  means that the test should be conducted with each test time reduced (within 10ms) so that the drift in characteristic value due to a temperature rise at chip junction can be ignored.

Note2) Unless otherwise specified,  $V_I=3.5\text{V}$ ,  $I_O=20\text{mA}$ ,  $C_O=10\mu\text{F}$

## ■ Electrical Characteristics (Ta=25°C)

### • AN8003/AN8003M (3V Type)

Parameter	Symbol	Condition	min	typ	max	Unit
Output voltage	$V_O$	$T_j=25^\circ\text{C}$	2.88	3	3.12	V
Line regulation	$\text{REG}_{\text{IN}}$	$V_I=3.5$ to 9V, $T_j=25^\circ\text{C}$	—	3	50	mV
Load regulation	$\text{REG}_{\text{L}}$	$I_O=1$ to 40mA, $T_j=25^\circ\text{C}$	—	9	25	mV
		$I_O=1$ to 50mA, $T_j=25^\circ\text{C}$	—	15	30	mV
Minimum I/O voltage difference	$V_{\text{DIF (min.)}}$	$V_I=2.9\text{V}$ , $I_O=20\text{mA}$ , $T_j=25^\circ\text{C}$	—	0.07	0.2	V
		$V_I=2.9\text{V}$ , $I_O=50\text{mA}$ , $T_j=25^\circ\text{C}$	—	0.12	0.3	V
Bias current	$I_{\text{bias}}$	$I_O=0\text{mA}$ , $T_j=25^\circ\text{C}$	—	0.6	1	mA
Ripple rejection ratio	RR	$V_I=4$ to 6V, $f=120\text{Hz}$	58	70	—	dB
Output noise voltage	$V_{\text{no}}$	$f=10\text{Hz}$ to 100kHz	—	70	—	$\mu\text{V}$
Output voltage temperature coefficient	$\Delta V_O/T_a$	$T_j=-30$ to $+125^\circ\text{C}$	—	0.15	—	$\text{mV}/^\circ\text{C}$

Note1) The specified condition  $T_j=25^\circ\text{C}$  means that the test should be conducted with each test time reduced (within 10ms) so that the drift in characteristic value due to a temperature rise at chip junction can be ignored.

Note2) Unless otherwise specified,  $V_I=4\text{V}$ ,  $I_O=20\text{mA}$ ,  $C_O=10\mu\text{F}$

### • AN8035/AN8035M (3.5V Type)

Parameter	Symbol	Condition	min	typ	max	Unit
Output voltage	$V_O$	$T_j=25^\circ\text{C}$	3.36	3.5	3.64	V
Line regulation	$\text{REG}_{\text{IN}}$	$V_I=4$ to 9.5V, $T_j=25^\circ\text{C}$	—	3.5	50	mV
Load regulation	$\text{REG}_{\text{L}}$	$I_O=1$ to 40mA, $T_j=25^\circ\text{C}$	—	10	30	mV
		$I_O=1$ to 50mA, $T_j=25^\circ\text{C}$	—	20	40	mV
Minimum I/O voltage difference	$V_{\text{DIF (min.)}}$	$V_I=3.4\text{V}$ , $I_O=20\text{mA}$ , $T_j=25^\circ\text{C}$	—	0.07	0.2	V
		$V_I=3.4\text{V}$ , $I_O=50\text{mA}$ , $T_j=25^\circ\text{C}$	—	0.12	0.3	V
Bias current	$I_{\text{bias}}$	$I_O=0\text{mA}$ , $T_j=25^\circ\text{C}$	—	0.6	1	mA
Ripple rejection ratio	RR	$V_I=4.5$ to 6.5V, $f=120\text{Hz}$	57	69	—	dB
Output noise voltage	$V_{\text{no}}$	$f=10\text{Hz}$ to 100kHz	—	75	—	$\mu\text{V}$
Output voltage temperature coefficient	$\Delta V_O/T_a$	$T_j=-30$ to $+125^\circ\text{C}$	—	0.2	—	$\text{mV}/^\circ\text{C}$

Note1) The specified condition  $T_j=25^\circ\text{C}$  means that the test should be conducted with each test time reduced (within 10ms) so that the drift in characteristic value due to a temperature rise at chip junction can be ignored.

Note2) Unless otherwise specified,  $V_I=4.5\text{V}$ ,  $I_O=20\text{mA}$ ,  $C_O=10\mu\text{F}$

### • AN8004/AN8004M (4V Type)

Parameter	Symbol	Condition	min	typ	max	Unit
Output voltage	$V_O$	$T_j=25^\circ\text{C}$	3.84	4	4.16	V
Line regulation	$\text{REG}_{\text{IN}}$	$V_I=4.5$ to 10V, $T_j=25^\circ\text{C}$	—	3.5	50	mV
Load regulation	$\text{REG}_{\text{L}}$	$I_O=1$ to 40mA, $T_j=25^\circ\text{C}$	—	10	30	mV
		$I_O=1$ to 50mA, $T_j=25^\circ\text{C}$	—	20	40	mV
Minimum I/O voltage difference	$V_{\text{DIF (min.)}}$	$V_I=3.8\text{V}$ , $I_O=20\text{mA}$ , $T_j=25^\circ\text{C}$	—	0.07	0.2	V
		$V_I=3.8\text{V}$ , $I_O=50\text{mA}$ , $T_j=25^\circ\text{C}$	—	0.12	0.3	V
Bias current	$I_{\text{bias}}$	$I_O=0\text{mA}$ , $T_j=25^\circ\text{C}$	—	0.6	1	mA
Ripple rejection ratio	RR	$V_I=5$ to 7V, $f=120\text{Hz}$	56	67	—	dB
Output noise voltage	$V_{\text{no}}$	$f=10\text{Hz}$ to 100kHz	—	80	—	$\mu\text{V}$
Output voltage temperature coefficient	$\Delta V_O/T_a$	$T_j=-30$ to $+125^\circ\text{C}$	—	0.2	—	$\text{mV}/^\circ\text{C}$

Note1) The specified condition  $T_j=25^\circ\text{C}$  means that the test should be conducted with each test time reduced (within 10ms) so that the drift in characteristic value due to a temperature rise at chip junction can be ignored.

Note2) Unless otherwise specified,  $V_I=5\text{V}$ ,  $I_O=20\text{mA}$ ,  $C_O=10\mu\text{F}$

## ■ Electrical Characteristics (Ta=25°C)

### • AN8045/AN8045M (4.5V Type)

Parameter	Symbol	Condition	min	typ	max	Unit
Output voltage	$V_O$	$T_j=25^\circ\text{C}$	4.32	4.5	4.68	V
Line regulation	$\text{REG}_{\text{IN}}$	$V_I=5$ to $10.5\text{V}$ , $T_j=25^\circ\text{C}$	—	4	50	mV
Load regulation	$\text{REG}_{\text{L}}$	$I_O=1$ to $40\text{mA}$ , $T_j=25^\circ\text{C}$	—	11	35	mV
		$I_O=1$ to $50\text{mA}$ , $T_j=25^\circ\text{C}$	—	23	45	mV
Minimum I/O voltage difference	$V_{\text{DIF (min.)}}$	$V_I=4.3\text{V}$ , $I_O=20\text{mA}$ , $T_j=25^\circ\text{C}$	—	0.07	0.2	V
		$V_I=4.3\text{V}$ , $I_O=50\text{mA}$ , $T_j=25^\circ\text{C}$	—	0.12	0.3	V
Bias current	$I_{\text{bias}}$	$I_O=0\text{mA}$ , $T_j=25^\circ\text{C}$	—	0.7	1	mA
Ripple rejection ratio	RR	$V_I=5.5$ to $7.5\text{V}$ , $f=120\text{Hz}$	54	66	—	dB
Output noise voltage	$V_{\text{no}}$	$f=10\text{Hz}$ to $100\text{kHz}$	—	85	—	$\mu\text{V}$
Output voltage temperature coefficient	$\Delta V_O/T_a$	$T_j=-30$ to $+125^\circ\text{C}$	—	0.23	—	$\text{mV}/^\circ\text{C}$

Note1) The specified condition  $T_j=25^\circ\text{C}$  means that the test should be conducted with each test time reduced (within 10ms) so that the drift in characteristic value due to a temperature rise at chip junction can be ignored.

Note2) Unless otherwise specified,  $V_I=5.5\text{V}$ ,  $I_O=20\text{mA}$ ,  $C_O=10\mu\text{F}$

### • AN8005/AN8005M (5V Type)

Parameter	Symbol	Condition	min	typ	max	Unit
Output voltage	$V_O$	$T_j=25^\circ\text{C}$	4.8	5	5.2	V
Line regulation	$\text{REG}_{\text{IN}}$	$V_I=5.5$ to $11\text{V}$ , $T_j=25^\circ\text{C}$	—	4.5	50	mV
Load regulation	$\text{REG}_{\text{L}}$	$I_O=1$ to $40\text{mA}$ , $T_j=25^\circ\text{C}$	—	12	40	mV
		$I_O=1$ to $50\text{mA}$ , $T_j=25^\circ\text{C}$	—	25	50	mV
Minimum I/O voltage difference	$V_{\text{DIF (min.)}}$	$V_I=4.8\text{V}$ , $I_O=20\text{mA}$ , $T_j=25^\circ\text{C}$	—	0.07	0.2	V
		$V_I=4.8\text{V}$ , $I_O=50\text{mA}$ , $T_j=25^\circ\text{C}$	—	0.12	0.3	V
Bias current	$I_{\text{bias}}$	$I_O=0\text{mA}$ , $T_j=25^\circ\text{C}$	—	0.7	1	mA
Ripple rejection ratio	RR	$V_I=6$ to $8\text{V}$ , $f=120\text{Hz}$	52	64	—	dB
Output noise voltage	$V_{\text{no}}$	$f=10\text{Hz}$ to $100\text{kHz}$	—	95	—	$\mu\text{V}$
Output voltage temperature coefficient	$\Delta V_O/T_a$	$T_j=-30$ to $+125^\circ\text{C}$	—	0.25	—	$\text{mV}/^\circ\text{C}$

Note1) The specified condition  $T_j=25^\circ\text{C}$  means that the test should be conducted with each test time reduced (within 10ms) so that the drift in characteristic value due to a temperature rise at chip junction can be ignored.

Note2) Unless otherwise specified,  $V_I=6\text{V}$ ,  $I_O=20\text{mA}$ ,  $C_O=10\mu\text{F}$

### • AN8006/AN8006M (6V Type)

Parameter	Symbol	Condition	min	typ	max	Unit
Output voltage	$V_O$	$T_j=25^\circ\text{C}$	5.76	6	6.24	V
Line regulation	$\text{REG}_{\text{IN}}$	$V_I=6.5$ to $12\text{V}$ , $T_j=25^\circ\text{C}$	—	5.5	60	mV
Load regulation	$\text{REG}_{\text{L}}$	$I_O=1$ to $40\text{mA}$ , $T_j=25^\circ\text{C}$	—	13	45	mV
		$I_O=1$ to $50\text{mA}$ , $T_j=25^\circ\text{C}$	—	28	55	mV
Minimum I/O voltage difference	$V_{\text{DIF (min.)}}$	$V_I=5.8\text{V}$ , $I_O=20\text{mA}$ , $T_j=25^\circ\text{C}$	—	0.07	0.2	V
		$V_I=5.8\text{V}$ , $I_O=50\text{mA}$ , $T_j=25^\circ\text{C}$	—	0.13	0.3	V
Bias current	$I_{\text{bias}}$	$I_O=0\text{mA}$ , $T_j=25^\circ\text{C}$	—	0.7	1.2	mA
Ripple rejection ratio	RR	$V_I=7$ to $9\text{V}$ , $f=120\text{Hz}$	51	63	—	dB
Output noise voltage	$V_{\text{no}}$	$f=10\text{Hz}$ to $100\text{kHz}$	—	105	—	$\mu\text{V}$
Output voltage temperature coefficient	$\Delta V_O/T_a$	$T_j=-30$ to $+125^\circ\text{C}$	—	0.3	—	$\text{mV}/^\circ\text{C}$

Note1) The specified condition  $T_j=25^\circ\text{C}$  means that the test should be conducted with each test time reduced (within 10ms) so that the drift in characteristic value due to a temperature rise at chip junction can be ignored.

Note2) Unless otherwise specified,  $V_I=7\text{V}$ ,  $I_O=20\text{mA}$ ,  $C_O=10\mu\text{F}$

## ■ Electrical Characteristics (Ta=25°C)

### • AN8007/AN8007M (7V Type)

Parameter	Symbol	Condition	min	typ	max	Unit
Output voltage	$V_O$	$T_j=25^\circ\text{C}$	6.72	7	7.28	V
Line regulation	$\text{REG}_{\text{IN}}$	$V_I=7.5$ to 13V, $T_j=25^\circ\text{C}$	—	6.5	70	mV
Load regulation	$\text{REG}_{\text{L}}$	$I_O=1$ to 40mA, $T_j=25^\circ\text{C}$	—	14	50	mV
		$I_O=1$ to 50mA, $T_j=25^\circ\text{C}$	—	31	60	mV
Minimum I/O voltage difference	$V_{\text{DIF (min.)}}$	$V_I=6.8\text{V}$ , $I_O=20\text{mA}$ , $T_j=25^\circ\text{C}$	—	0.07	0.2	V
		$V_I=6.8\text{V}$ , $I_O=50\text{mA}$ , $T_j=25^\circ\text{C}$	—	0.13	0.3	V
Bias current	$I_{\text{bias}}$	$I_O=0\text{mA}$ , $T_j=25^\circ\text{C}$	—	0.7	1.3	mA
Ripple rejection ratio	RR	$V_I=8$ to 10V, $f=120\text{Hz}$	50	62	—	dB
Output noise voltage	$V_{\text{no}}$	$f=10\text{Hz}$ to 100kHz	—	120	—	$\mu\text{V}$
Output voltage temperature coefficient	$\Delta V_O/T_a$	$T_j=-30$ to $+125^\circ\text{C}$	—	0.35	—	$\text{mV}/^\circ\text{C}$

Note1) The specified condition  $T_j=25^\circ\text{C}$  means that the test should be conducted with each test time reduced (within 10ms) so that the drift in characteristic value due to a temperature rise at chip junction can be ignored.

Note2) Unless otherwise specified,  $V_I=8\text{V}$ ,  $I_O=20\text{mA}$ ,  $C_O=10\mu\text{F}$

### • AN8008/AN8008M (8V Type)

Parameter	Symbol	Condition	min	typ	max	Unit
Output voltage	$V_O$	$T_j=25^\circ\text{C}$	7.68	8	8.32	V
Line regulation	$\text{REG}_{\text{IN}}$	$V_I=8.5$ to 14V, $T_j=25^\circ\text{C}$	—	7.5	80	mV
Load regulation	$\text{REG}_{\text{L}}$	$I_O=1$ to 40mA, $T_j=25^\circ\text{C}$	—	15	55	mV
		$I_O=1$ to 50mA, $T_j=25^\circ\text{C}$	—	34	65	mV
Minimum I/O voltage difference	$V_{\text{DIF (min.)}}$	$V_I=7.8\text{V}$ , $I_O=20\text{mA}$ , $T_j=25^\circ\text{C}$	—	0.07	0.2	V
		$V_I=7.8\text{V}$ , $I_O=50\text{mA}$ , $T_j=25^\circ\text{C}$	—	0.14	0.3	V
Bias current	$I_{\text{bias}}$	$I_O=0\text{mA}$ , $T_j=25^\circ\text{C}$	—	0.7	1.3	mA
Ripple rejection ratio	RR	$V_I=9$ to 11V, $f=120\text{Hz}$	49	61	—	dB
Output noise voltage	$V_{\text{no}}$	$f=10\text{Hz}$ to 100kHz	—	135	—	$\mu\text{V}$
Output voltage temperature coefficient	$\Delta V_O/T_a$	$T_j=-30$ to $+125^\circ\text{C}$	—	0.4	—	$\text{mV}/^\circ\text{C}$

Note1) The specified condition  $T_j=25^\circ\text{C}$  means that the test should be conducted with each test time reduced (within 10ms) so that the drift in characteristic value due to a temperature rise at chip junction can be ignored.

Note2) Unless otherwise specified,  $V_I=9\text{V}$ ,  $I_O=20\text{mA}$ ,  $C_O=10\mu\text{F}$

### • AN8085/AN8085M (8.5V Type)

Parameter	Symbol	Condition	min	typ	max	Unit
Output voltage	$V_O$	$T_j=25^\circ\text{C}$	8.16	8.50	8.84	V
Line regulation	$\text{REG}_{\text{IN}}$	$V_I=9$ to 14.5V, $T_j=25^\circ\text{C}$	—	8.3	90	mV
Load regulation	$\text{REG}_{\text{L}}$	$I_O=1$ to 40mA, $T_j=25^\circ\text{C}$	—	16	60	mV
		$I_O=1$ to 50mA, $T_j=25^\circ\text{C}$	—	36	70	mV
Minimum I/O voltage difference	$V_{\text{DIF (min.)}}$	$V_I=8.3\text{V}$ , $I_O=20\text{mA}$ , $T_j=25^\circ\text{C}$	—	0.07	0.2	V
		$V_I=8.3\text{V}$ , $I_O=50\text{mA}$ , $T_j=25^\circ\text{C}$	—	0.14	0.3	V
Bias current	$I_{\text{bias}}$	$I_O=0\text{mA}$ , $T_j=25^\circ\text{C}$	—	0.8	1.4	mA
Ripple rejection ratio	RR	$V_I=9.5$ to 11.5V, $f=120\text{Hz}$	48	60	—	dB
Output noise voltage	$V_{\text{no}}$	$f=10\text{Hz}$ to 100kHz	—	140	—	$\mu\text{V}$
Output voltage temperature coefficient	$\Delta V_O/T_a$	$T_j=-30$ to $+125^\circ\text{C}$	—	0.43	—	$\text{mV}/^\circ\text{C}$

Note1) The specified condition  $T_j=25^\circ\text{C}$  means that the test should be conducted with each test time reduced (within 10ms) so that the drift in characteristic value due to a temperature rise at chip junction can be ignored.

Note2) Unless otherwise specified,  $V_I=9.5\text{V}$ ,  $I_O=20\text{mA}$ ,  $C_O=10\mu\text{F}$

## ■ Electrical Characteristics (Ta=25°C)

### • AN8009/AN8009M (9V Type)

Parameter	Symbol	Condition	min	typ	max	Unit
Output voltage	$V_O$	$T_j=25^\circ\text{C}$	8.64	9	9.36	V
Line regulation	$\text{REG}_{\text{IN}}$	$V_I=9.5$ to $15\text{V}$ , $T_j=25^\circ\text{C}$	—	9	100	mV
Load regulation	$\text{REG}_{\text{L}}$	$I_O=1$ to $40\text{mA}$ , $T_j=25^\circ\text{C}$	—	17	70	mV
		$I_O=1$ to $50\text{mA}$ , $T_j=25^\circ\text{C}$	—	37	75	mV
Minimum I/O voltage difference	$V_{\text{DIF (min.)}}$	$V_I=8.8\text{V}$ , $I_O=20\text{mA}$ , $T_j=25^\circ\text{C}$	—	0.07	0.2	V
		$V_I=8.8\text{V}$ , $I_O=50\text{mA}$ , $T_j=25^\circ\text{C}$	—	0.14	0.3	V
Bias current	$I_{\text{bias}}$	$I_O=0\text{mA}$ , $T_j=25^\circ\text{C}$	—	0.8	1.4	mA
Ripple rejection ratio	RR	$V_I=10$ to $12\text{V}$ , $f=120\text{Hz}$	47	59	—	dB
Output noise voltage	$V_{\text{no}}$	$f=10\text{Hz}$ to $100\text{kHz}$	—	150	—	$\mu\text{V}$
Output voltage temperature coefficient	$\Delta V_O/T_a$	$T_j=-30$ to $+125^\circ\text{C}$	—	0.45	—	$\text{mV}/^\circ\text{C}$

Note1) The specified condition  $T_j=25^\circ\text{C}$  means that the test should be conducted with each test time reduced (within 10ms) so that the drift in characteristic value due to a temperature rise at chip junction can be ignored.

Note2) Unless otherwise specified,  $V_I=10\text{V}$ ,  $I_O=20\text{mA}$ ,  $C_O=10\mu\text{F}$

### • AN8010/AN8010M (10V Type)

Parameter	Symbol	Condition	min	typ	max	Unit
Output voltage	$V_O$	$T_j=25^\circ\text{C}$	9.6	10	10.4	V
Line regulation	$\text{REG}_{\text{IN}}$	$V_I=10.5$ to $16\text{V}$ , $T_j=25^\circ\text{C}$	—	10	100	mV
Load regulation	$\text{REG}_{\text{L}}$	$I_O=1$ to $40\text{mA}$ , $T_j=25^\circ\text{C}$	—	18	75	mV
		$I_O=1$ to $50\text{mA}$ , $T_j=25^\circ\text{C}$	—	40	85	mV
Minimum I/O voltage difference	$V_{\text{DIF (min.)}}$	$V_I=9.8\text{V}$ , $I_O=20\text{mA}$ , $T_j=25^\circ\text{C}$	—	0.07	0.2	V
		$V_I=9.8\text{V}$ , $I_O=50\text{mA}$ , $T_j=25^\circ\text{C}$	—	0.14	0.3	V
Bias current	$I_{\text{bias}}$	$I_O=0\text{mA}$ , $T_j=25^\circ\text{C}$	—	0.8	1.4	mA
Ripple rejection ratio	RR	$V_I=11$ to $13\text{V}$ , $f=120\text{Hz}$	46	58	—	dB
Output noise voltage	$V_{\text{no}}$	$f=10\text{Hz}$ to $100\text{kHz}$	—	165	—	$\mu\text{V}$
Output voltage temperature coefficient	$\Delta V_O/T_a$	$T_j=-30$ to $+125^\circ\text{C}$	—	0.5	—	$\text{mV}/^\circ\text{C}$

Note1) The specified condition  $T_j=25^\circ\text{C}$  means that the test should be conducted with each test time reduced (within 10ms) so that the drift in characteristic value due to a temperature rise at chip junction can be ignored.

Note2) Unless otherwise specified,  $V_I=11\text{V}$ ,  $I_O=20\text{mA}$ ,  $C_O=10\mu\text{F}$

## ■ Application Circuit

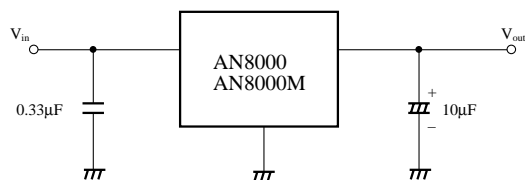

- The AN8000/AN8000M series has IC internal gain increased in order to improve performance. When the power line on the output side is long, use a capacitor of  $10\mu\text{F}$ .  
For the capacitor on the output side, attach it as close to the IC as possible.
- When using at a low temperature, it is recommended to use the capacitors with low internal impedance (for example, tantalum capacitor) for output capacitors.

## ■ Characteristic Curve

$P_D - T_a$  (AN8000 Series)

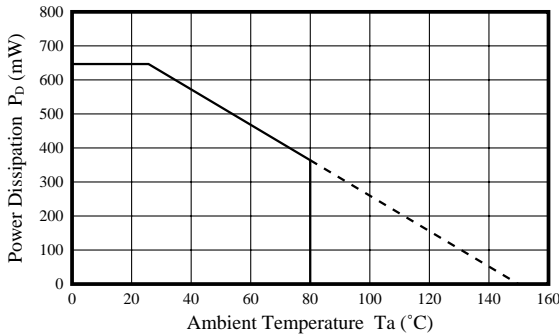

$P_D - T_a$  (AN8000M Series)

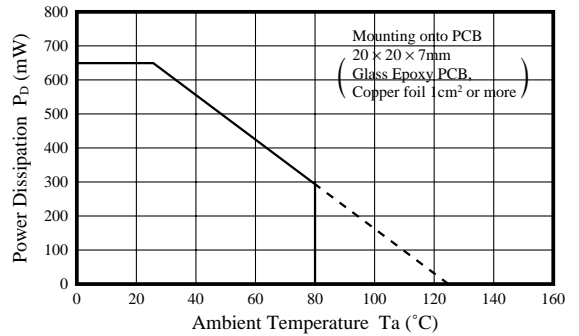

RR - f

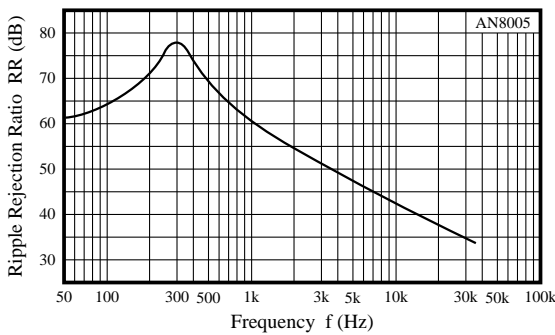

$V_O - V_I$

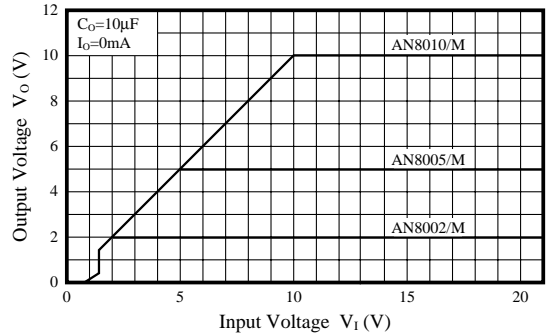

$V_O - I_O$

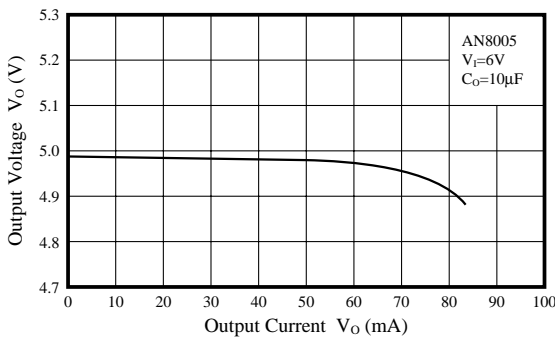

$V_O - T_a$

