

D1FK70

700V 0.8A

特長

- 小型SMD
- 高耐圧
- 低ノイズ
- $V_{RM} = 700V$

Feature

- Small SMD
- High Voltage
- Low Noise
- $V_{RM} = 700V$

用途

- スイッチング電源
- DC/DC コンバータ
- フライホール
- 家電、OA、照明
- 通信、FA

Main Use

- Switching Regulator
- DC/DC Converter
- Fly Wheel
- Home Appliance, Office Automation, Lighting
- Communication, Factory Automation

■ 外観図 OUTLINE

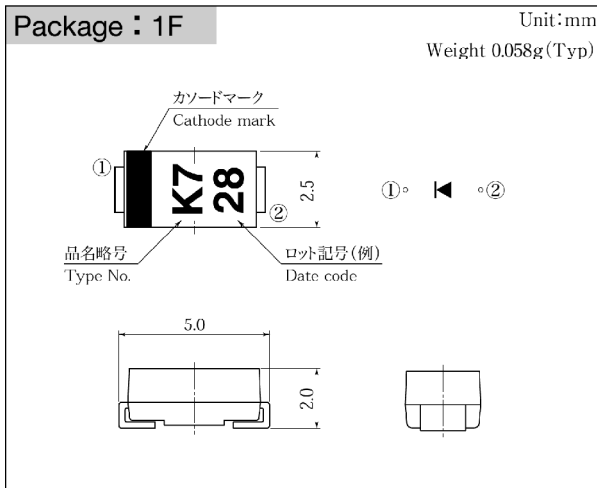

外形図については新電元Webサイト又は〈ダイオードカタログ・技術資料編〉を参照下さい。捺印表示については捺印仕様をご確認下さい。

For details of the outline dimensions, refer to our web site or the diode technical data book. As for the marking, refer to the specification "Marking, Terminal Connection".

■ 定格表 RATINGS

● 絶対最大定格 Absolute Maximum Ratings (指定のない場合 $T_l = 25^\circ C$)

項目 Item	記号 Symbol	条件 Conditions	品名 Type No.	D1FK70	単位 Unit
保存温度 Storage Temperature	T_{stg}			-55~150	$^\circ C$
接合部温度 Operation Junction Temperature	T_j			150	$^\circ C$
せん頭逆電圧 Maximum Reverse Voltage	V_{RM}			700	V
出力電流 Average Rectified Forward Current	I_o	50Hz 正弦波, 抵抗負荷 50Hz sine wave, Resistance load	$T_a = 32^\circ C$ アルミナ基板実装 On alumina substrate	0.8	A
			$T_a = 33^\circ C$ プリント基板実装 On glass-epoxy substrate	0.6	
せん頭サージ順電流 Peak Surge Forward Current	I_{FSM}	50Hz 正弦波, 非繰り返し1サイクルせん頭値, $T_j = 25^\circ C$ 50Hz sine wave, Non-repetitive 1 cycle peak value, $T_j = 25^\circ C$		25	A

● 電氣的・熱的特性 Electrical Characteristics (指定のない場合 $T_l = 25^\circ C$)

順電圧 Forward Voltage	V_F	$I_F = 0.8A$, パルス測定 Pulse measurement		MAX 1.3	V
逆電流 Reverse Current	I_R	$V_R = V_{RM}$, パルス測定 Pulse measurement		MAX 10	μA
逆回復時間 Reverse Recovery Time	t_{rr}	$I_F = 0.5A, I_R = 1A$		MAX 400	ns
接合容量 Junction Capacitance	C_j	$f = 1MHz, V_R = 10V$		TYP 7	pF
熱抵抗 Thermal Resistance	θ_{jl}	接合部・リード間 Junction to lead		MAX 23	$^\circ C/W$
	θ_{ja}	接合部・周囲間 Junction to ambient	アルミナ基板実装 On alumina substrate プリント基板実装 On glass-epoxy substrate	MAX 108 MAX 157	

★記載内容は製品改良のためにお断りなしに変更することがあります。

★All specifications are subject to change without notice.

■特性図 CHARACTERISTIC DIAGRAMS

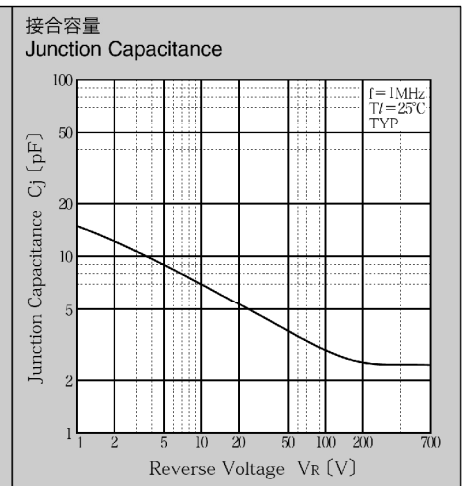
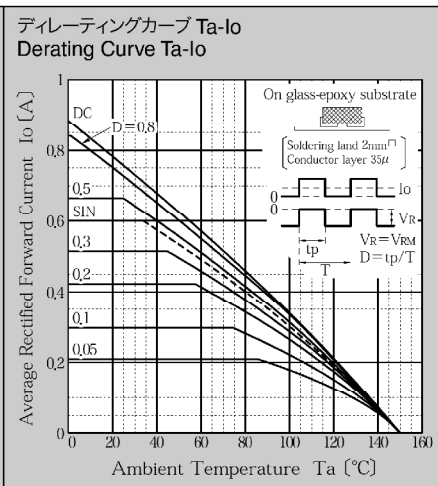
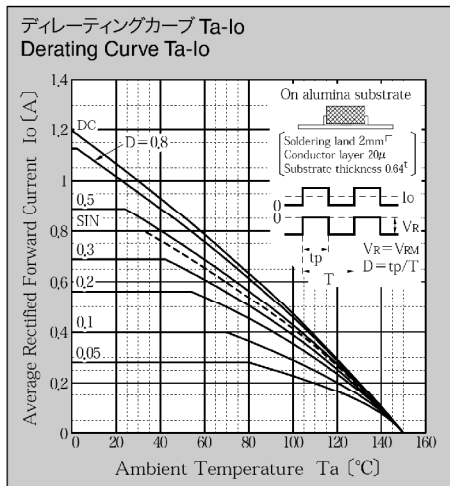
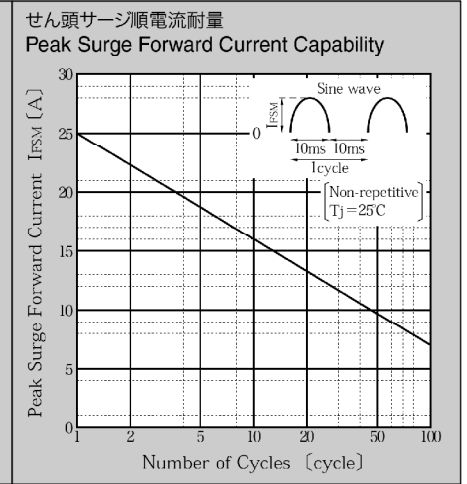
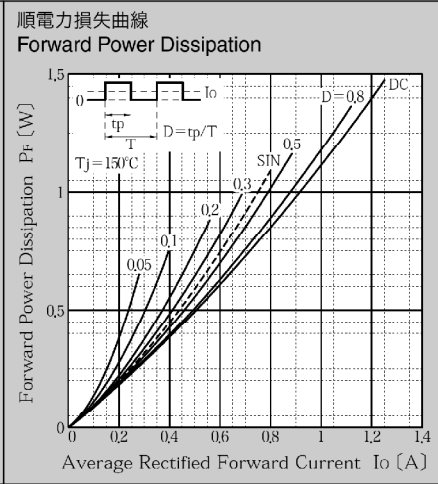
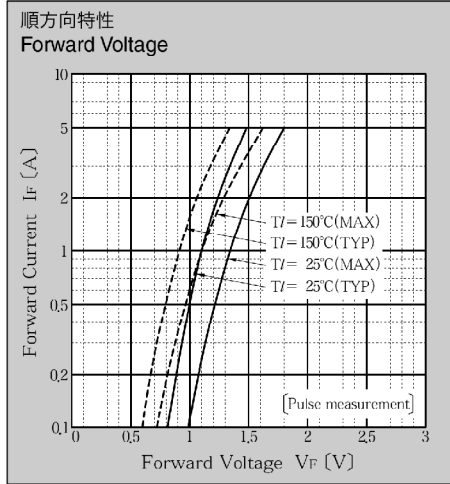

* Sine waveは50Hzで測定しています。
* 50Hz sine wave is used for measurements.
* 半導体製品の特性は一般的にバラツキを持っています。
Typicalは統計的な実力を表しています。
* Semiconductor products generally have characteristic variation.
Typical is a statistical average of the device's ability.