

SIPMOS® Small-Signal Transistor

- N channel
- Enhancement mode
- Logic Level
- $V_{GS(th)} = 0.8...2.0V$

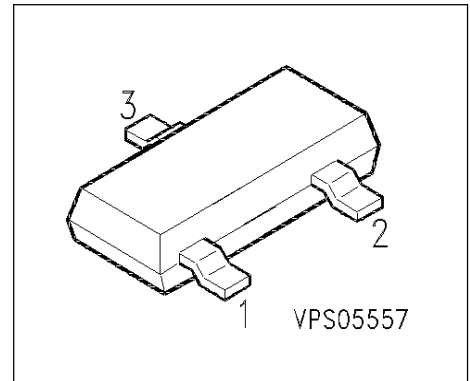

Pin 1	Pin 2	Pin 3
G	S	D

Type	V_{DS}	I_D	$R_{DS(on)}$	Package	Marking
SN 7002	60 V	0.19 A	5 Ω	SOT-23	sSG

Type	Ordering Code	Tape and Reel Information
SN 7002	Q67000-S063	E6327

Maximum Ratings

Parameter	Symbol	Values	Unit
Drain source voltage	V_{DS}	60	V
Drain-gate voltage $R_{GS} = 20 \text{ k}\Omega$	V_{DGR}	60	
Gate source voltage	V_{GS}	± 14	
Gate-source peak voltage, aperiodic	V_{gs}	± 20	
Continuous drain current $T_A = 25 \text{ }^\circ\text{C}$	I_D	0.19	A
DC drain current, pulsed $T_A = 25 \text{ }^\circ\text{C}$	I_{Dpuls}	0.76	
Power dissipation $T_A = 25 \text{ }^\circ\text{C}$	P_{tot}	0.36	W

Maximum Ratings

Parameter	Symbol	Values	Unit
Chip or operating temperature	T_j	-55 ... + 150	°C
Storage temperature	T_{stg}	-55 ... + 150	
Thermal resistance, chip to ambient air	R_{thJA}	≤ 350	K/W
Thermal resistance, chip-substrate- reverse side ¹⁾	R_{thJSR}	≤ 285	
DIN humidity category, DIN 40 040		E	
IEC climatic category, DIN IEC 68-1		55 / 150 / 56	

1) For package mounted on aluminium 15 mm x 16.7 mm x 0.7 mm

Electrical Characteristics, at $T_j = 25^\circ\text{C}$, unless otherwise specified

Parameter	Symbol	Values			Unit
		min.	typ.	max.	

Static Characteristics

Drain- source breakdown voltage $V_{GS} = 0\text{ V}, I_D = 0.25\text{ mA}, T_j = 25\text{ }^\circ\text{C}$	$V_{(BR)DSS}$	60	-	-	V
Gate threshold voltage $V_{GS} = V_{DS}, I_D = 1\text{ mA}$	$V_{GS(th)}$	0.8	1.4	2	
Zero gate voltage drain current $V_{DS} = 60\text{ V}, V_{GS} = 0\text{ V}, T_j = 25\text{ }^\circ\text{C}$ $V_{DS} = 60\text{ V}, V_{GS} = 0\text{ V}, T_j = 125\text{ }^\circ\text{C}$	I_{DSS}	-	0.1	1	μA
Gate-source leakage current $V_{GS} = 20\text{ V}, V_{DS} = 0\text{ V}$	I_{GSS}	-	1	10	
Drain-Source on-state resistance $V_{GS} = 10\text{ V}, I_D = 0.5\text{ A}$ $V_{GS} = 4.5\text{ V}, I_D = 0.05\text{ A}$	$R_{DS(on)}$	-	2	5	Ω
		-	3	7.5	

Electrical Characteristics, at $T_j = 25^\circ\text{C}$, unless otherwise specified

Parameter	Symbol	Values			Unit
		min.	typ.	max.	

Dynamic Characteristics

Transconductance $V_{DS} \geq 2 * I_D * R_{DS(on)max}, I_D = 0.2 \text{ A}$	g_{fs}	0.1	0.2	-	S
Input capacitance $V_{GS} = 0 \text{ V}, V_{DS} = 25 \text{ V}, f = 1 \text{ MHz}$	C_{iss}	-	60	80	pF
Output capacitance $V_{GS} = 0 \text{ V}, V_{DS} = 25 \text{ V}, f = 1 \text{ MHz}$	C_{oss}	-	15	25	
Reverse transfer capacitance $V_{GS} = 0 \text{ V}, V_{DS} = 25 \text{ V}, f = 1 \text{ MHz}$	C_{rss}	-	15	25	
Turn-on delay time $V_{DD} = 30 \text{ V}, V_{GS} = 10 \text{ V}, I_D = 0.29 \text{ A}$ $R_{GS} = 50 \Omega$	$t_{d(on)}$	-	5	8	ns
Rise time $V_{DD} = 30 \text{ V}, V_{GS} = 10 \text{ V}, I_D = 0.29 \text{ A}$ $R_{GS} = 50 \Omega$	t_r	-	5	8	
Turn-off delay time $V_{DD} = 30 \text{ V}, V_{GS} = 10 \text{ V}, I_D = 0.29 \text{ A}$ $R_{GS} = 50 \Omega$	$t_{d(off)}$	-	12	16	
Fall time $V_{DD} = 30 \text{ V}, V_{GS} = 10 \text{ V}, I_D = 0.29 \text{ A}$ $R_{GS} = 50 \Omega$	t_f	-	13	17	

Electrical Characteristics, at $T_j = 25^\circ\text{C}$, unless otherwise specified

Parameter	Symbol	Values			Unit
		min.	typ.	max.	
Reverse Diode					
Inverse diode continuous forward current $T_A = 25^\circ\text{C}$	I_S	-	-	0.19	A
Inverse diode direct current, pulsed $T_A = 25^\circ\text{C}$	I_{SM}	-	-	0.76	
Inverse diode forward voltage $V_{GS} = 0\text{ V}, I_F = 0.5\text{ A}, T_j = 25^\circ\text{C}$	V_{SD}	-	1	1.2	V

Power dissipation

$$P_{\text{tot}} = f(T_A)$$

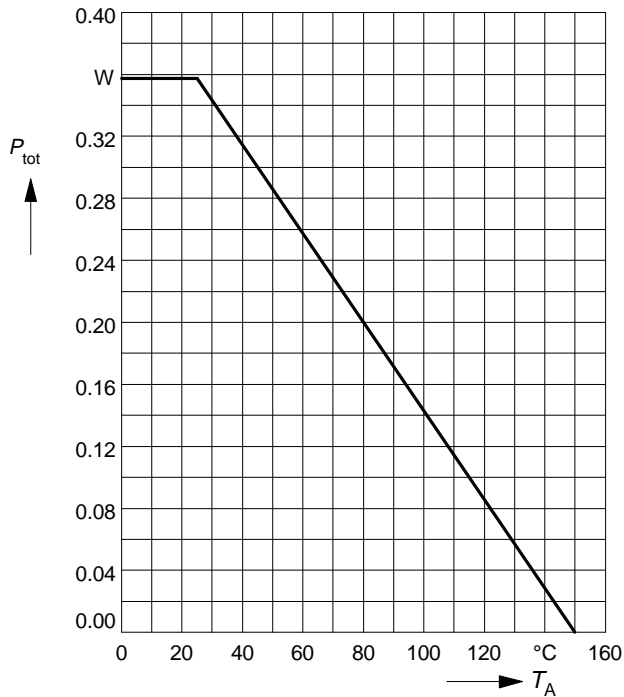

Drain current

$$I_D = f(T_A)$$

parameter: $V_{\text{GS}} \geq 10 \text{ V}$

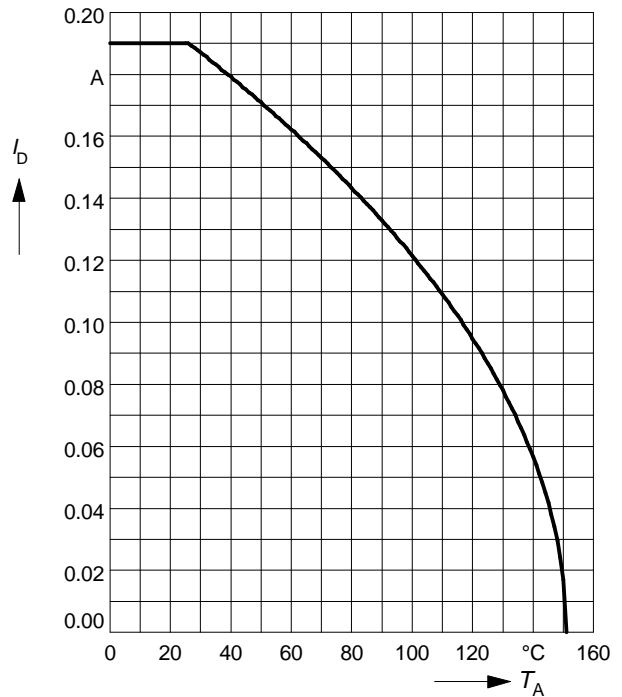

Safe operating area $I_D = f(V_{\text{DS}})$

parameter: $D = 0.01$, $T_C = 25^\circ\text{C}$

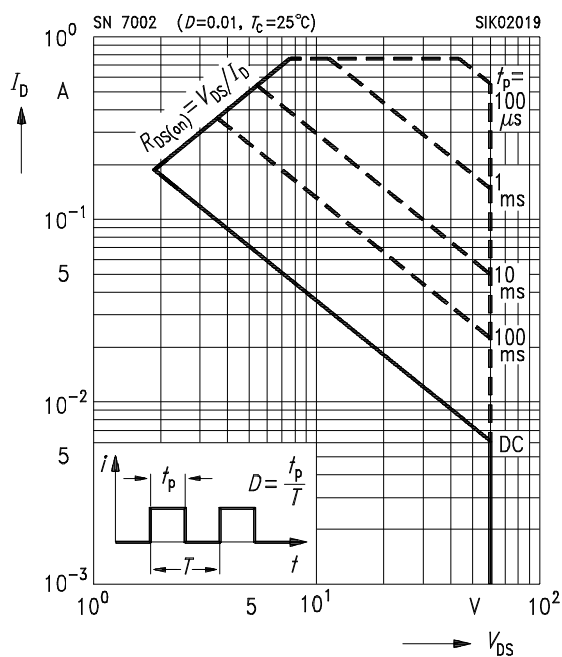

Drain-source breakdown voltage

$$V_{(\text{BR})\text{DSS}} = f(T_j)$$

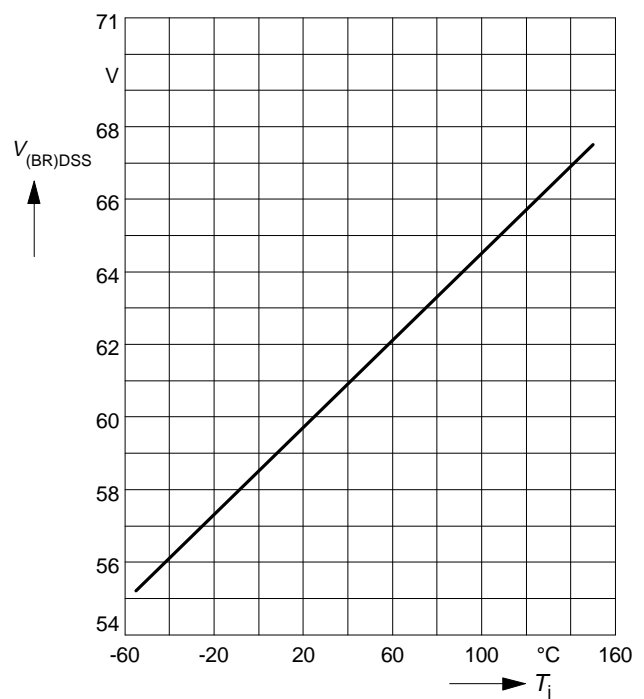

Typ. output characteristics

$$I_D = f(V_{DS})$$

parameter: $t_p = 80 \mu s$, $T_j = 25^\circ C$

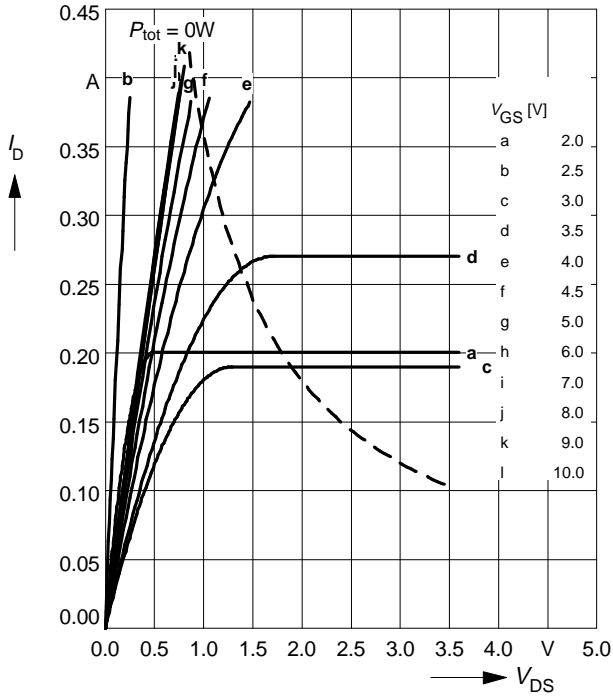

Typ. drain-source on-resistance

$$R_{DS(on)} = f(I_D)$$

parameter: $t_p = 80 \mu s$, $T_j = 25^\circ C$

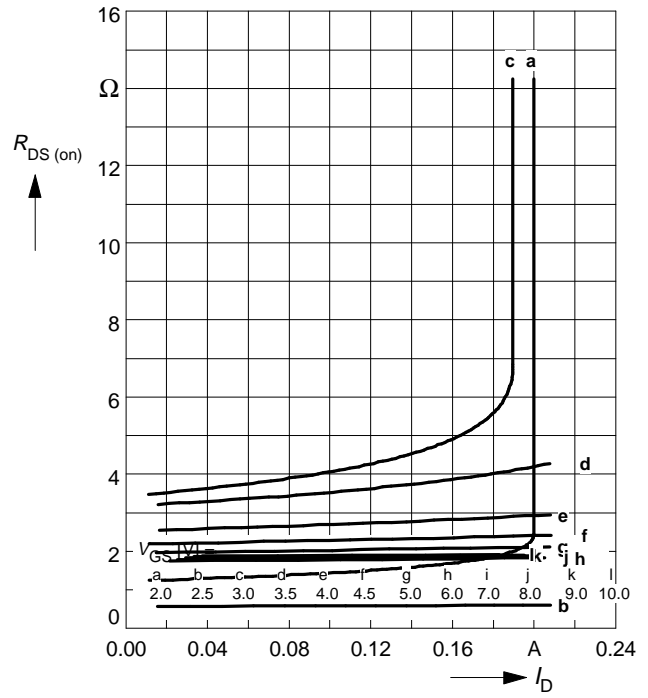

Typ. transfer characteristics $I_D = f(V_{GS})$

parameter: $t_p = 80 \mu s$

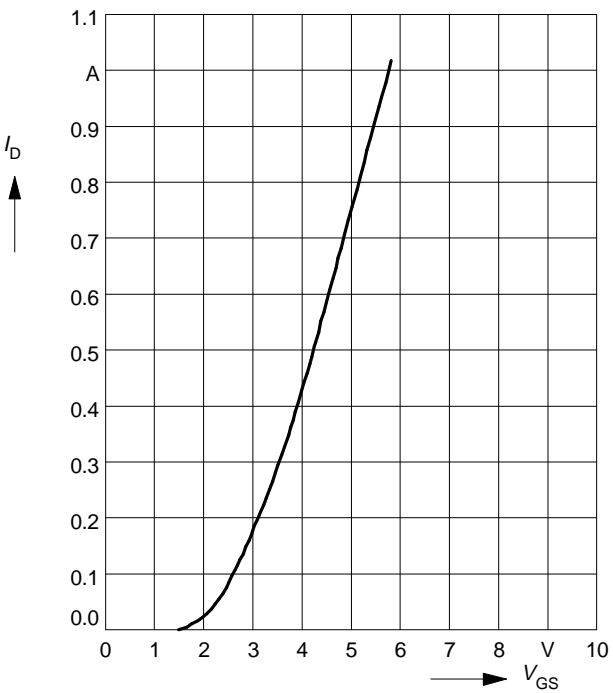

Typ. forward transconductance $g_{fs} = f(I_D)$

parameter: $t_p = 80 \mu s$

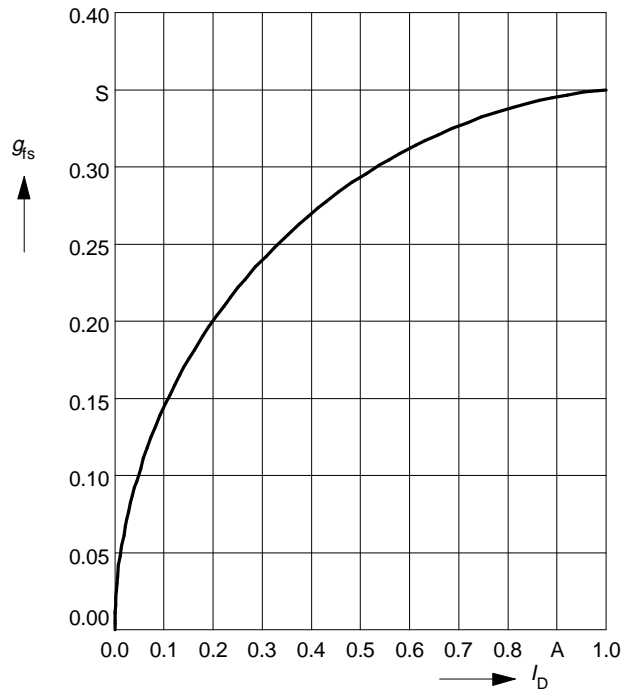

Drain-source on-resistance

$$R_{DS(on)} = f(T_j)$$

parameter: $I_D = 0.5 \text{ A}$, $V_{GS} = 10 \text{ V}$

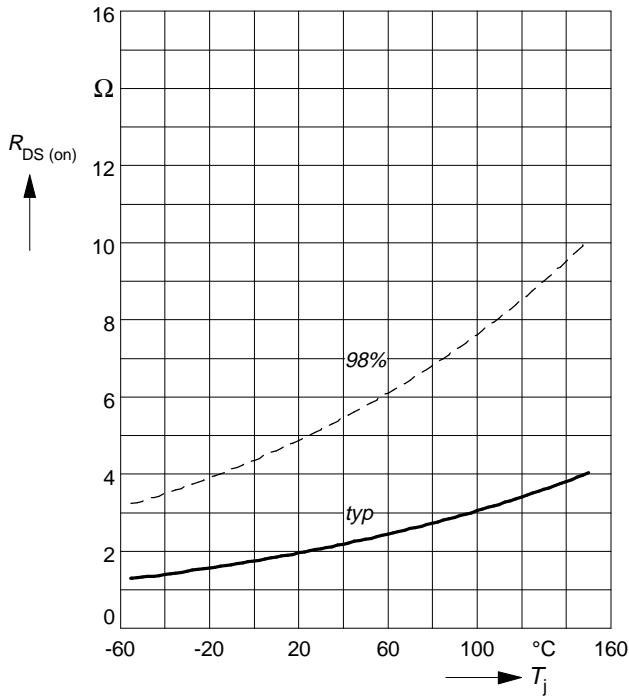

Gate threshold voltage

$$V_{GS(th)} = f(T_j)$$

parameter: $V_{GS} = V_{DS}$, $I_D = 1 \text{ mA}$

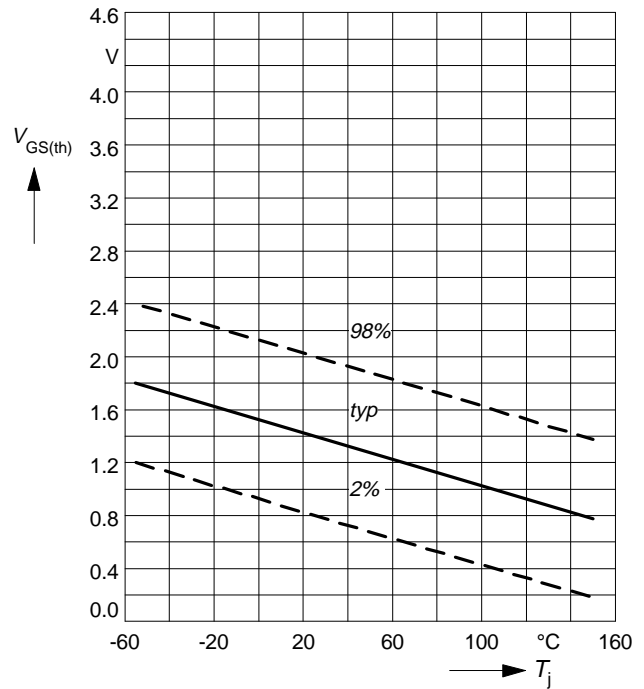

Typ. capacitances

$$C = f(V_{DS})$$

parameter: $V_{GS} = 0 \text{ V}$, $f = 1 \text{ MHz}$

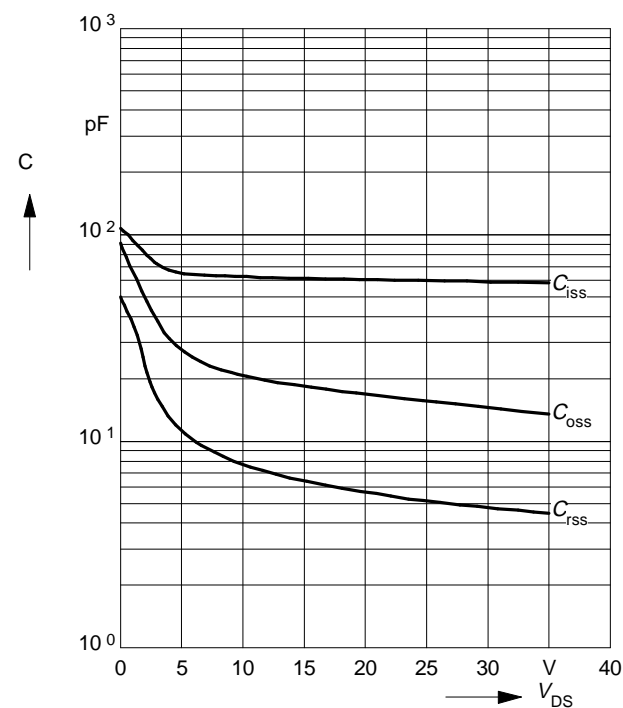

Forward characteristics of reverse diode

$$I_F = f(V_{SD})$$

parameter: T_j , $t_p = 80 \mu\text{s}$

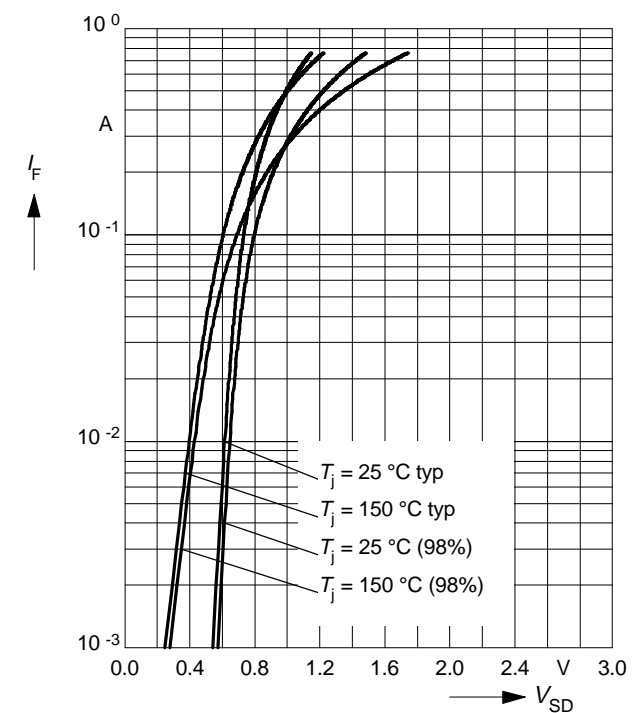

Package outlines

SOT-23

Dimensions in mm

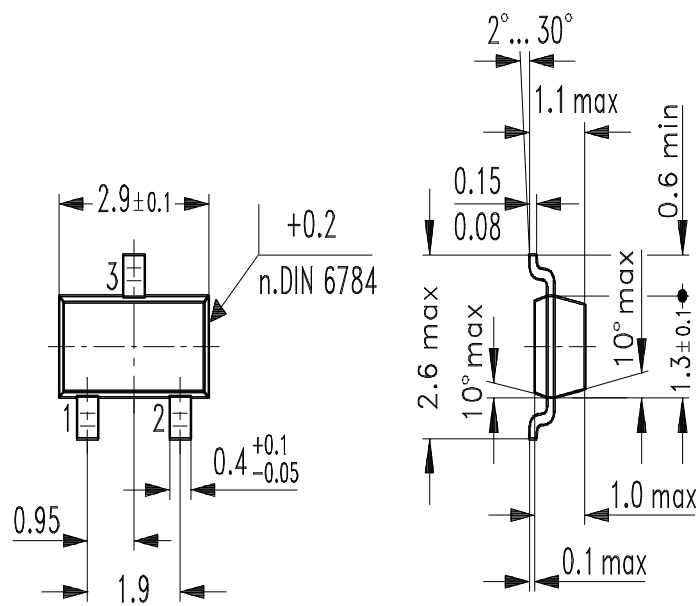

GPS05557