

# IRLR8103VPbF

- N-Channel Application-Specific MOSFETs
- Ideal for CPU Core DC-DC Converters
- Low Conduction Losses
- Low Switching Losses
- Minimizes Parallel MOSFETs for high current applications
- 100%  $R_G$  Tested
- Lead-Free

### Description

This new device employs advanced HEXFET Power MOSFET technology to achieve an unprecedented balance of on-resistance and gate charge. The reduced conduction and switching losses make it ideal for high efficiency DC-DC converters that power the latest generation of microprocessors.

The IRLR8103V has been optimized for all parameters that are critical in synchronous buck converters including  $R_{DS(on)}$ , gate charge and  $C_{dv}/dt$ -induced turn-on immunity. The IRLR8103V offers an extremely low combination of  $Q_{sw}$  &  $R_{DS(on)}$  for reduced losses in both control and synchronous FET applications.

The package is designed for vapor phase, infra-red, convection, or wave soldering techniques. Power dissipation of greater than 2W is possible in a typical PCB mount application.

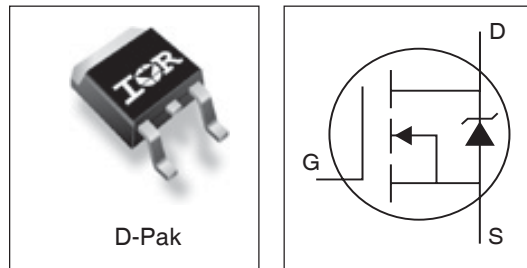

### DEVICE CHARACTERISTICS<sup>⑤</sup>

	<b>IRLR8103V</b>
$R_{DS(on)}$	7.9 m $\Omega$
$Q_G$	27 nC
$Q_{SW}$	12 nC
$Q_{OSS}$	29nC

### Absolute Maximum Ratings

Parameter		Symbol	IRLR8103V	Units
Drain-Source Voltage		$V_{DS}$	30	V
Gate-Source Voltage		$V_{GS}$	$\pm 20$	
Continuous Drain or Source Current ( $V_{GS} > 10V$ )	TC = 25°C	$I_D$	91	A
	TC = 90°C		63	
Pulsed Drain Current <sup>①</sup>		$I_{DM}$	363	
Power Dissipation <sup>③</sup>	TC = 25°C	$P_D$	115	W
	TC = 90°C		60	
Junction & Storage Temperature Range		$T_J, T_{STG}$	-55 to 150	°C
Continuous Source Current (Body Diode)		$I_S$	91	A
Pulsed Source Current <sup>①</sup>		$I_{SM}$	363	

### Thermal Resistance

Parameter	Symbol	Typ.	Max.	Units
Maximum Junction-to-Ambient <sup>③⑥</sup>	$R_{\theta JA}$	—	50	°C/W
Maximum Junction-to-Case <sup>⑥</sup>	$R_{\theta JC}$	—	1.09	

## Electrical Characteristics

Parameter	Symbol	Min	Typ	Max	Units	Conditions
Drain-to-Source Breakdown Voltage	$V_{DSS}$	30	—	—	V	$V_{GS} = 0V, I_D = 250\mu A$
Static Drain-Source On-Resistance	$R_{DS(on)}$	—	6.9	9.0	m $\Omega$	$V_{GS} = 10V, I_D = 15A$ ②
		—	7.9	10.5		$V_{GS} = 4.5V, I_D = 15A$ ②
Gate Threshold Voltage	$V_{GS(th)}$	1.0	—	3.0	V	$V_{DS} = V_{GS}, I_D = 250\mu A$
Drain-to-Source Leakage Current	$I_{DSS}$	—	—	50	$\mu A$	$V_{DS} = 30V, V_{GS} = 0V$
		—	—	20	$\mu A$	$V_{DS} = 24V, V_{GS} = 0$
		—	—	100		$V_{DS} = 24V, V_{GS} = 0, T_J = 100^\circ C$
Gate-Source Leakage Current	$I_{GSS}$	—	—	$\pm 100$	nA	$V_{GS} = \pm 20V$
Total Gate Charge, Control FET	$Q_G$	—	27	—	nC	$V_{GS} = 5V, I_D = 15A, V_{DS} = 16V$
Total Gate Charge, Synch FET	$Q_G$	—	23	—		$V_{GS} = 5V, V_{DS} < 100mV$
Pre-Vth Gate-Source Charge	$Q_{GS1}$	—	4.7	—		$V_{DS} = 16V, I_D = 15A$
Post-Vth Gate-Source Charge	$Q_{GS2}$	—	2.0	—		
Gate to Drain Charge	$Q_{GD}$	—	9.7	—		
Switch Charge ( $Q_{gs2} + Q_{gd}$ )	$Q_{SW}$	—	12	—		
Output Charge	$Q_{OSS}$	—	29	—		
Gate Resistance	$R_G$	0.8	—	3.1		$\Omega$
Turn-On Delay Time	$t_{d(on)}$	—	10	—	ns	$V_{DD} = 16V$
Rise Time	$t_r$	—	9	—		$I_D = 15A$
Turn-Off Delay Time	$t_{d(off)}$	—	24	—		$V_{GS} = 5.0V$
Fall Time	$t_f$	—	18	—		Clamped Inductive Load
Input Capacitance	$C_{iss}$	—	2672	—	pF	$V_{GS} = 16V, V_{GS}=0$
Output Capacitance	$C_{oss}$	—	1064	—		
Reverse Transfer Capacitance	$C_{rss}$	—	109	—		

## Source-Drain Rating & Characteristics

Parameter	Symbol	Min	Typ	Max	Units	Conditions
Diode Forward Voltage	$V_{SD}$	—	0.9	1.3	V	$I_S = 15A$ ②, $V_{GS} = 0V$
Reverse Recovery Charge ④	$Q_{rr}$	—	103	—	nC	$di/dt \sim 700A/\mu s$ $V_{DS} = 16V, V_{GS} = 0V, I_F = 15A$
Reverse Recovery Charge (with Parallel Schottky) ④	$Q_{rr(s)}$	—	96	—	nC	$di/dt = 700A/\mu s$ , (with 10BQ040) $V_{DS} = 16V, V_{GS} = 0V, I_F = 15A$

### Notes:

- ① Repetitive rating; pulse width limited by max. junction temperature.
- ② Pulse width  $\leq 400 \mu s$ ; duty cycle  $\leq 2\%$ .
- ③ When mounted on 1 inch square copper board,  $t < 10$  sec.
- ④ Typ = measured -  $Q_{oss}$
- ⑤ Typical values of  $R_{DS(on)}$  measured at  $V_{GS} = 4.5V$ ,  $Q_G$ ,  $Q_{SW}$  and  $Q_{OSS}$  measured at  $V_{GS} = 5.0V$ ,  $I_F = 15A$ .

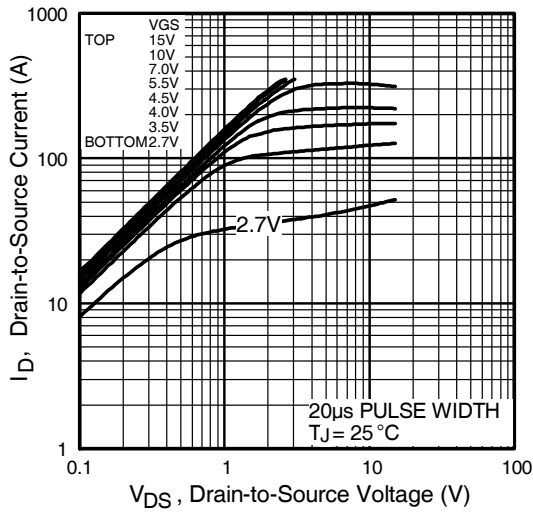

**Fig 1.** Typical Output Characteristics

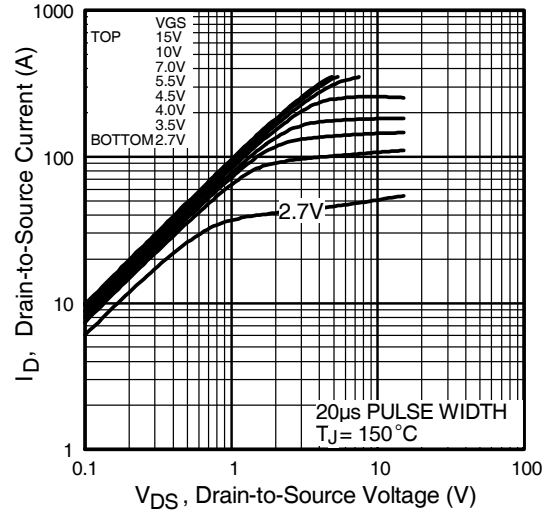

**Fig 2.** Typical Output Characteristics

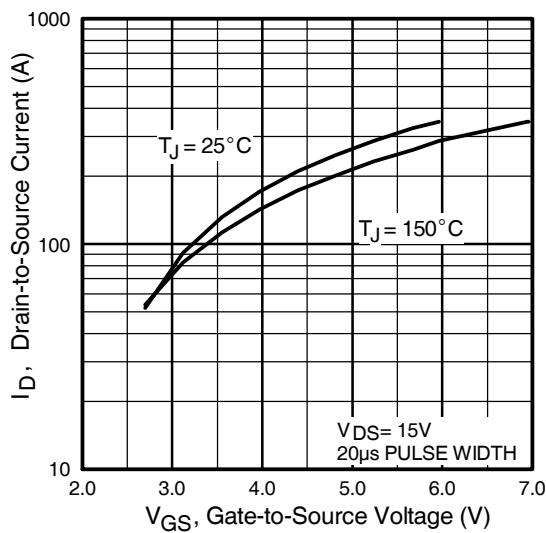

**Fig 3.** Typical Transfer Characteristics

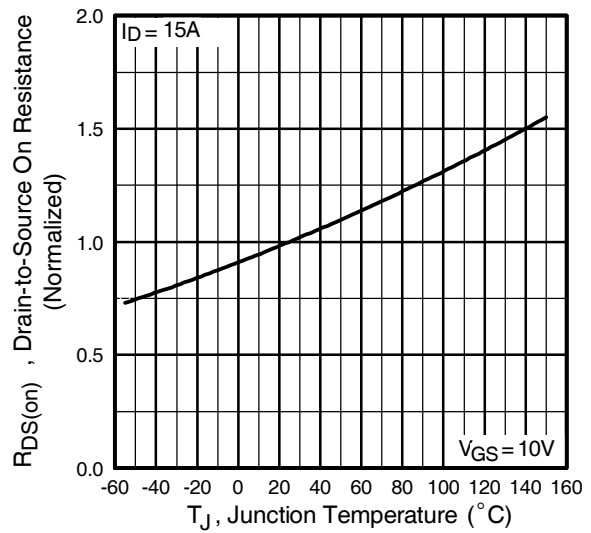

**Fig 4.** Normalized On-Resistance Vs. Temperature

# IRLR8103VPbF

International  
**IR** Rectifier

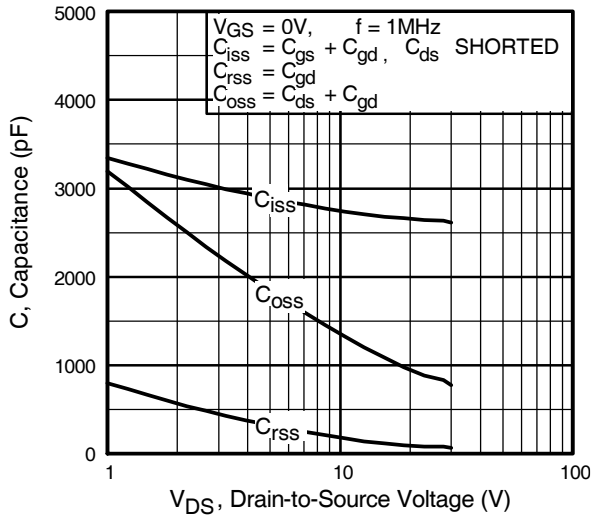

**Fig 5.** Typical Capacitance Vs. Drain-to-Source Voltage

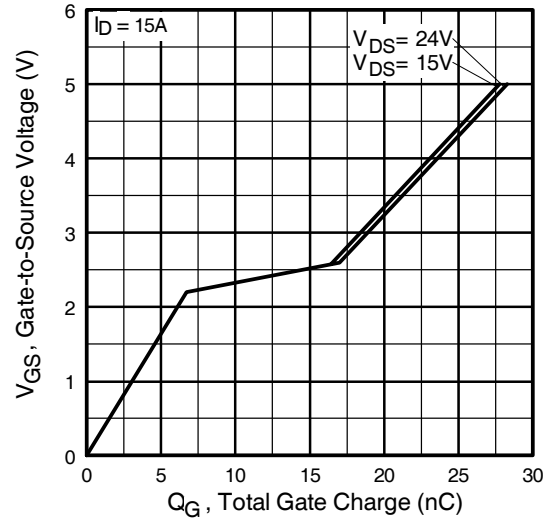

**Fig 6.** Typical Gate Charge Vs. Gate-to-Source Voltage

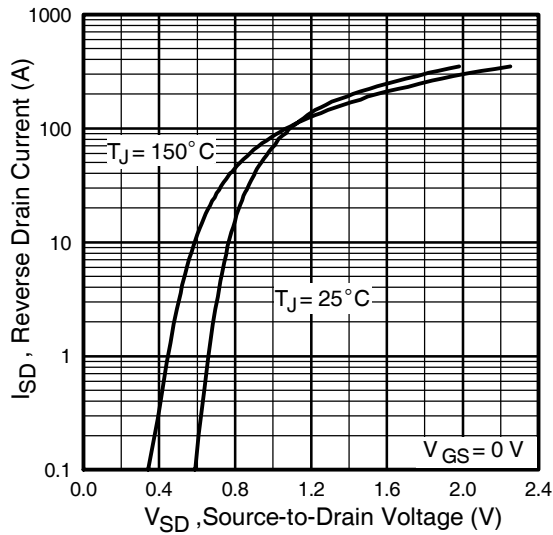

**Fig 7.** Typical Source-Drain Diode Forward Voltage

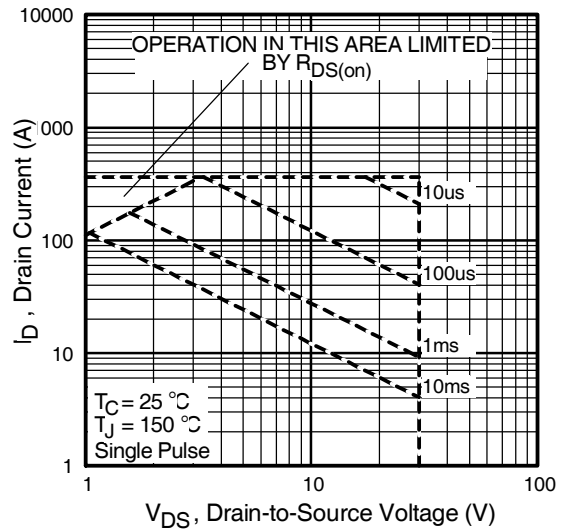

**Fig 8.** Maximum Safe Operating Area

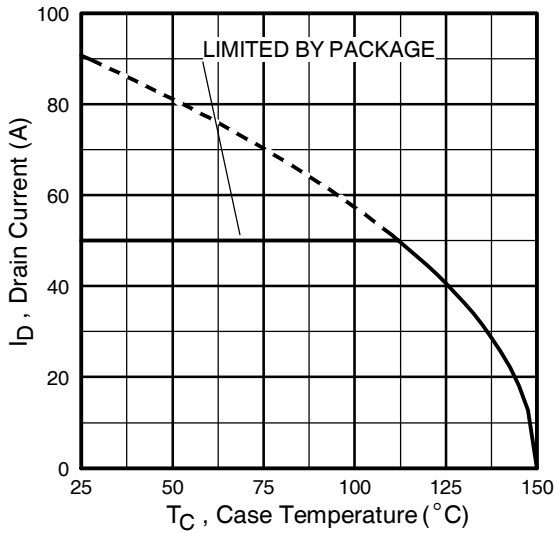

**Fig 9. Maximum Drain Current Vs. Case Temperature**

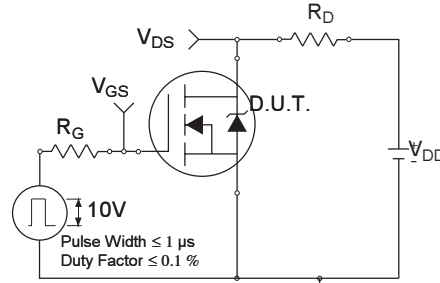

**Fig 10a. Switching Time Test Circuit**



**Fig 10b. Switching Time Waveforms**

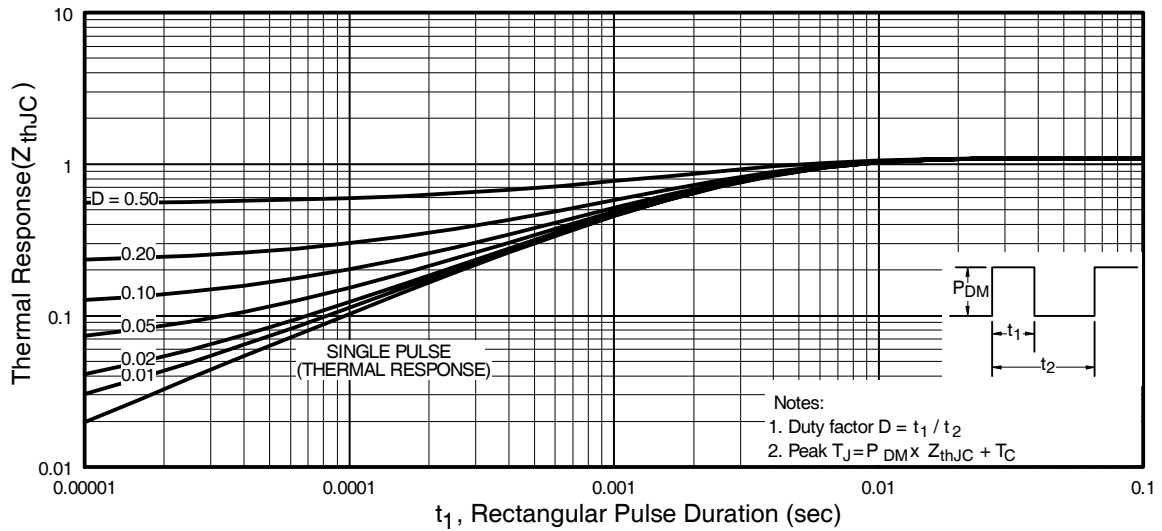

**Fig 11. Maximum Effective Transient Thermal Impedance, Junction-to-Case**

# IRLR8103VPbF

International  
**IR** Rectifier

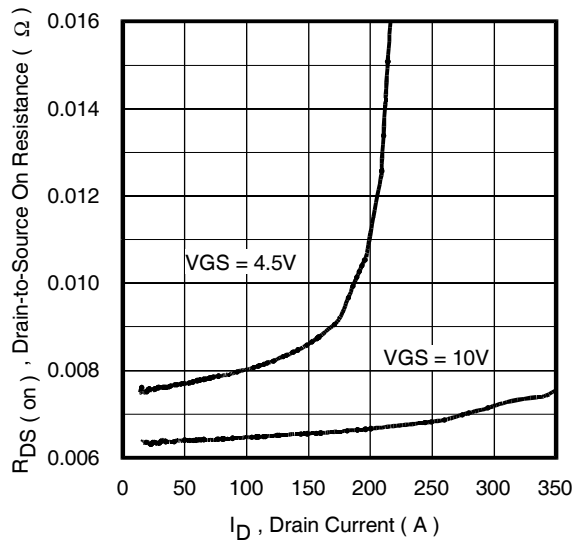

**Fig 12.** On-Resistance Vs. Drain Current

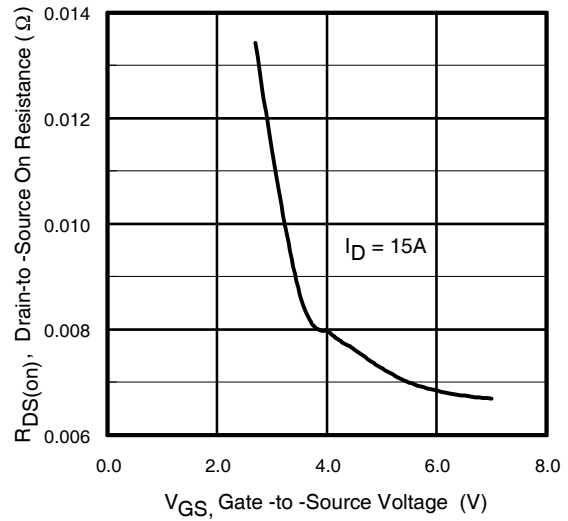

**Fig 13.** On-Resistance Vs. Gate Voltage

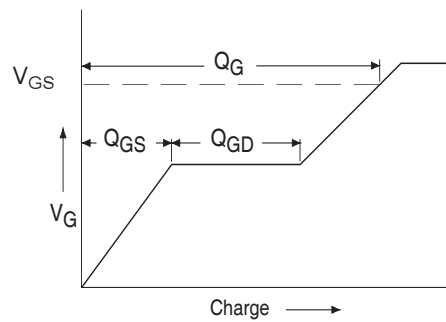
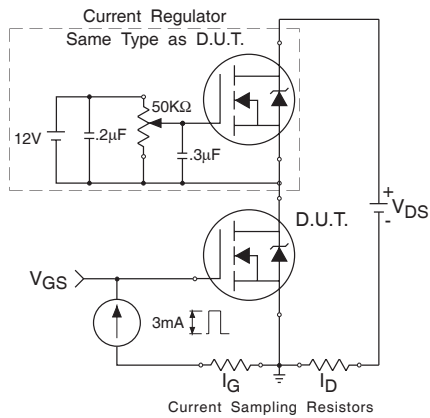

**Fig 14a&b.** Basic Gate Charge Test Circuit and Waveform

## D-Pak (TO-252AA) Package Outline

Dimensions are shown in millimeters (inches)

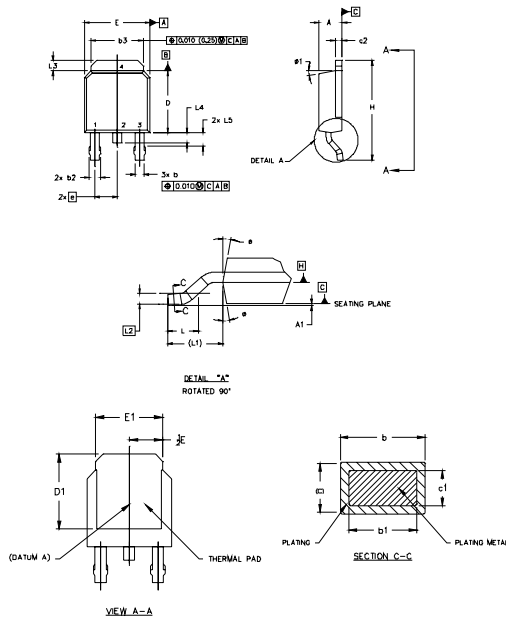

NOTES:

- 1.0 DIMENSIONING AND TOLERANCING PER ASME Y14.5 M- 1994.
- 2.0 DIMENSIONS ARE SHOWN IN INCHES [MILLIMETERS].
- 3.0 LEAD DIMENSION UNCONTROLLED IN L5.
- 4.0 DIMENSION D1 AND E1 ESTABLISH A MINIMUM MOUNTING SURFACE FOR THERMAL PAD.
- 5.0 SECTION C-C DIMENSIONS APPLY TO THE FLAT SECTION OF THE LEAD BETWEEN .005 (0.127) AND .010 (0.254) FROM THE LEAD TIP.
- 6.0 DIMENSION D & E DO NOT INCLUDE MOLD FLASH. MOLD FLASH SHALL NOT EXCEED .005" (0.127) PER SIDE. THESE DIMENSIONS ARE MEASURED AT THE OUTERMOST EXTREMES OF THE PLASTIC BODY.
- 7.0 OUTLINE CONFORMS TO JEDEC OUTLINE TO-252AA.

SYMBOL	DIMENSIONS				NOTES
	MILLIMETERS		INCHES		
	MIN.	MAX.	MIN.	MAX.	
A	2.18	2.39	.086	.094	
A1		0.13		.005	
b	0.84	0.98	.033	.039	5
b1	0.84	0.79	.033	.031	5
b2	0.76	1.14	.030	.045	
b3	4.93	5.46	.193	.215	
c	0.48	0.61	.018	.024	5
c1	0.41	0.56	.016	.022	5
c2	0.96	0.98	.038	.039	5
D	0.97	0.22	.239	.249	6
D1	0.21	-	.005	-	4
E	6.35	6.13	.250	.245	6
E1	4.32	-	.170	-	4
e	2.29		.090 BSC		
H	6.48	10.41	.250	.410	
L	1.40	1.76	.055	.070	
L1	2.74 REF.		.108 REF.		
L2	0.50 BSC		.020 BSC		
L3	0.88	1.27	.035	.050	
L4		1.02		.040	
L5	1.14	1.52	.045	.060	3
#	0"	10"	0"	10"	
#1	0"	10"	0"	10"	

LEAD ASSIGNMENTS

- 1- GATE
- 2- DRAIN
- 3- SOURCE
- 4- DRAIN

IRFES. COPACK

- 1- GATE
- 2- COLLECTOR
- 3- EMITTER
- 4- COLLECTOR

## D-Pak (TO-252AA) Part Marking Information

EXAMPLE: THIS IS AN IRFR120  
WITH ASSEMBLY  
LOT CODE 1234  
ASSEMBLED ON WW 16, 1999  
IN THE ASSEMBLY LINE "A"

Note: "P" in assembly line position  
indicates "Lead-Free"

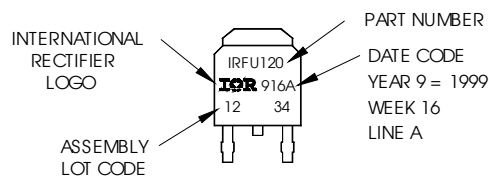

OR

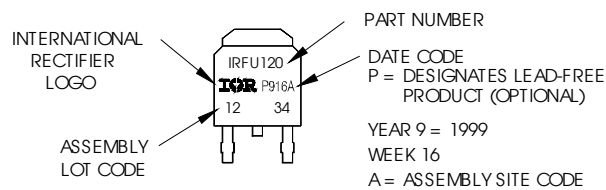

# IRLR8103VPbF

International  
**IR** Rectifier

## D-Pak (TO-252AA) Tape & Reel Information

Dimensions are shown in millimeters (inches)

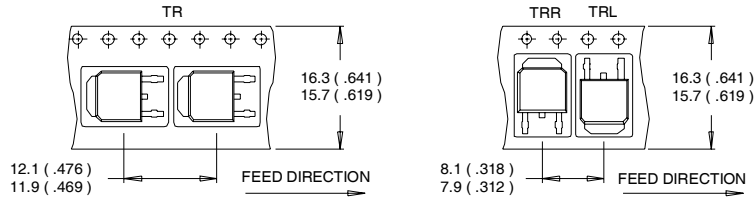

- NOTES :
1. CONTROLLING DIMENSION : MILLIMETER.
  2. ALL DIMENSIONS ARE SHOWN IN MILLIMETERS ( INCHES ).
  3. OUTLINE CONFORMS TO EIA-481 & EIA-541.

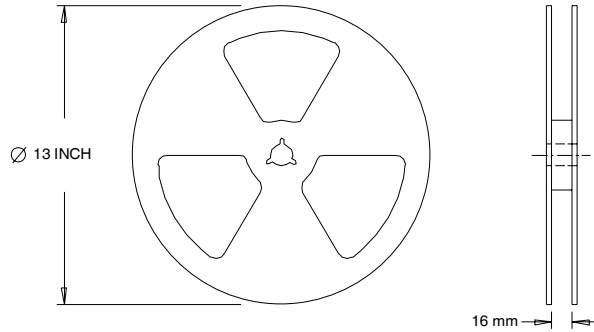

- NOTES :
1. OUTLINE CONFORMS TO EIA-481.

Data and specifications subject to change without notice.

International  
**IR** Rectifier

IR WORLD HEADQUARTERS: 233 Kansas St., El Segundo, California 90245, USA Tel: (310) 252-7105  
TAC Fax: (310) 252-7903

Visit us at [www.irf.com](http://www.irf.com) for sales contact information.12/04

[www.irf.com](http://www.irf.com)