

ADJUSTABLE PRECISION ZENER SHUNT REGULATOR

ZH431

Issue 2 - February 1998

DEVICE DESCRIPTION

The ZH431 is a three terminal adjustable shunt regulator offering excellent temperature stability and output current handling capability up to 30mA. The output voltage may be set to any chosen voltage between 2.5 and 36 volts by selection of two external divider resistors.

The devices can be used as a replacement for zener diodes in many applications requiring an improvement in zener performance. They are also ideal for use in the feedback circuits of off line SMPUs as well as many general purpose regulator and reference applications where initial accuracy and low temperature coefficient are key requirements.

Note:

ZH431 is not recommended for new designs.
Refer to ZR431

FEATURES

- Surface mount SO8, SOT223, SOT23 and SOT89 packages
- TO92 package
- 2% and 1% tolerance
- Maximum temperature coefficient 55 ppm/°C
- Temperature compensated for operation over the full temperature range
- Programmable output voltage
- 50µA to 30mA current sink capability
- Low output noise

APPLICATIONS

- Shunt regulator
- Series regulator
- Voltage monitor
- Over voltage/ under voltage protection
- Switch mode power supplies

SCHEMATIC DIAGRAM

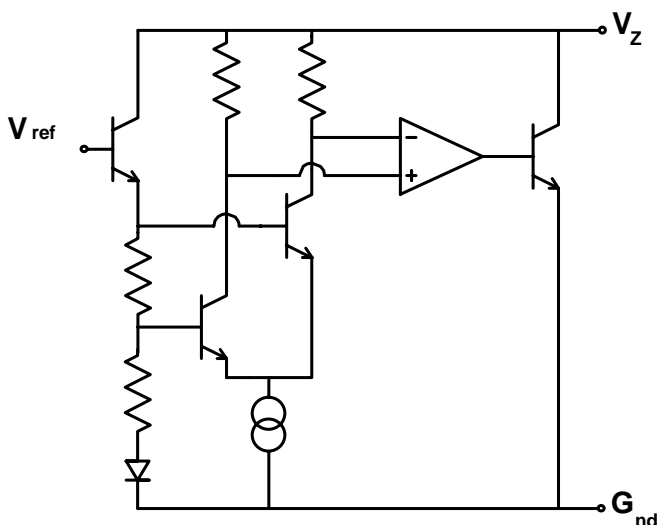

ZH431

ABSOLUTE MAXIMUM RATING

Cathode Voltage (V _Z)	40V
Cathode Current	50mA
Operating Temperature	-40 to 85°C
Storage Temperature	-55 to 125°C

Power Dissipation (T_{amb}=25°C, T_{jmax}=150°C)

SOT23	330mW
T092	780mW
SOT223	2W
SO8	780mW
SOT89	1.5W

Recommended Operating Conditions

	Min	Max
Cathode Voltage	V _{ref}	36V
Cathode Current	50μA	30mA

ELECTRICAL CHARACTERISTICS TEST CONDITIONS (Unless otherwise stated): T_{amb}=25°C

PARAMETER	SYMBOL	VALUE			UNITS	CONDITIONS
		MIN	TYP	MAX		
Reference Voltage	2% V _{ref} 1%	2.45	2.50	2.55	V	I _L =10mA (Fig1), V _Z =V _{ref}
Deviation of Reference Input Voltage over Temperature	V _{dev}		8.0	17	mV	I _L =10mA, V _Z =V _{ref} T _a =full range (Fig1)
Ratio of the change in Reference Voltage to the Change in Cathode Voltage	$\frac{\Delta V_{ref}}{\Delta V_Z}$		-0.7	-2.7	mV/V	V _Z from V _{ref} to 10V I _Z =10mA (Fig2)
			-0.6	-2.0	mV/V	V _Z from 10V to 36V I _Z =10mA (Fig2)
Reference Input Current	I _{ref}		0.15	1.0	μA	R1=10k, R2=O/C, I _L =10mA (Fig2)
Deviation of Reference Input Current over Temperature	ΔI _{ref}		0.06	0.2	μA	R1=10k, R2=O/C, I _L =10mA T _a =full range (Fig2)
Minimum Cathode Current for Regulation	I _{Zmin}		21	50	μA	V _Z =V _{ref} (Fig1)
Dynamic Output Impedance	R _Z			0.75	Ω	V _Z =V _{ref} (Fig1), f=0Hz

Deviation of reference input voltage, V_{dev}, is defined as the maximum variation of the reference input voltage over the full temperature range.

The average temperature coefficient of the reference input voltage, V_{ref} is defined as:

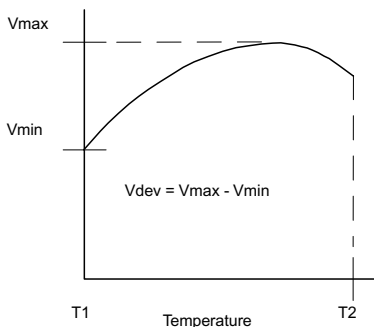

$$V_{ref} \text{ (ppm/}^\circ\text{C)} = \frac{V_{dev} \times 1000000}{V_{ref} (T_1 - T_2)}$$

The dynamic output impedance, R_Z, is defined as:

$$R_Z = \frac{\Delta V_Z}{\Delta I_Z}$$

When the device is programmed with two external resistors, R₁ and R₂, (fig 2), the dynamic output impedance of the overall circuit, R', is defined as:

$$R' = R_Z \left(1 + \frac{R_1}{R_2}\right)$$

ZH431

TYPICAL CHARACTERISTICS

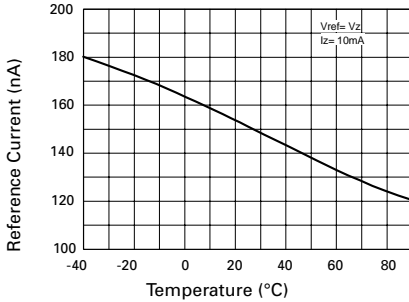

Reference Current v Temperature

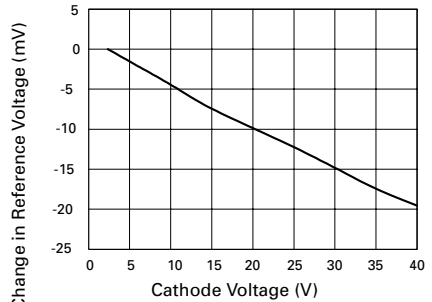

Change in Vref v Cathode Voltage

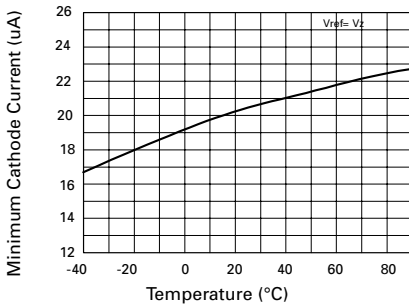

Cathode Current v Temperature

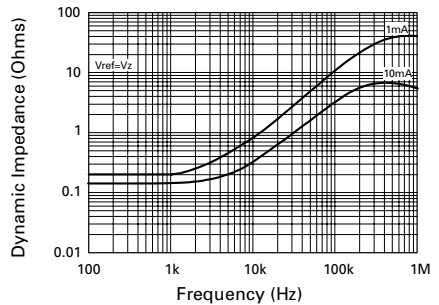

Dynamic Impedance v Frequency

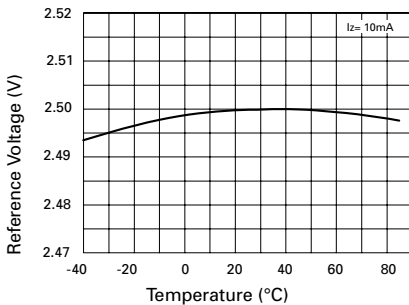

Reference Voltage v Temperature

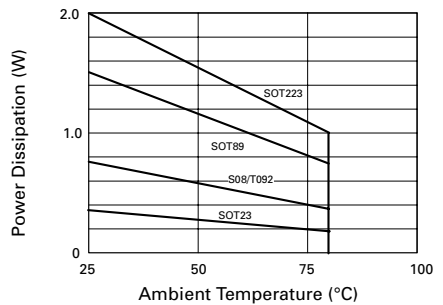

Power Dissipation Derating

ZH431

TYPICAL CHARACTERISTICS

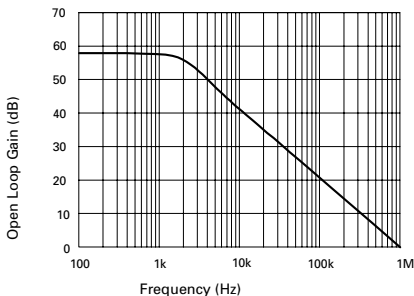

Gain v Frequency

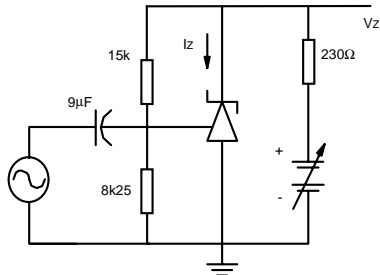

$I_z = 10\text{mA}$, $T_A = 25^\circ\text{C}$

Test Circuit for Open Loop Voltage Gain

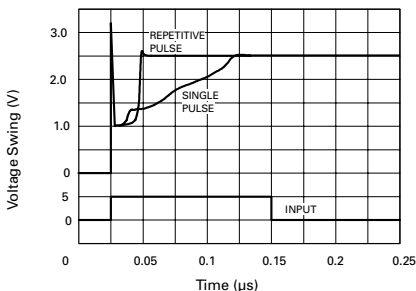

Pulse Response

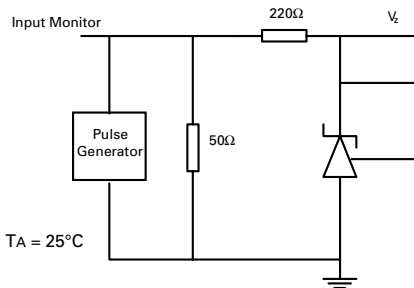

Test Circuit for Pulse Response

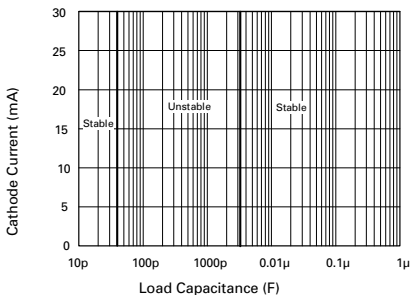

Stability Boundary Conditions

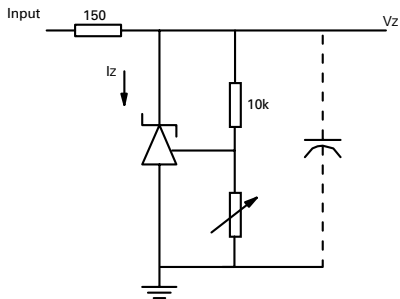

$V_{\text{ref}} < V_Z < 40$, $I_z = 10\text{mA}$, $T_A = 25^\circ\text{C}$

Test Circuit for Stability Boundary Conditions

DC TEST CIRCUITS

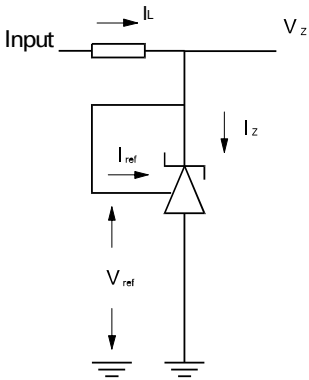

Fig 1 – Test Circuit for $V_z = V_{ref}$

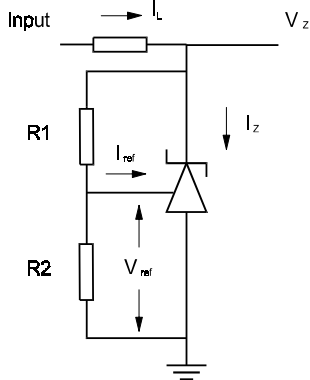
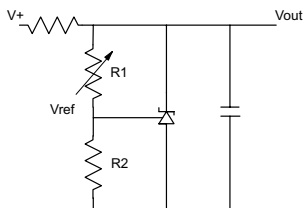

Fig 2 – Test Circuit for $V_z > V_{ref}$

ZH431

APPLICATION CIRCUITS



$$V_{out} = \left(1 + \frac{R1}{R2}\right) V_{ref}$$

SHUNT REGULATOR

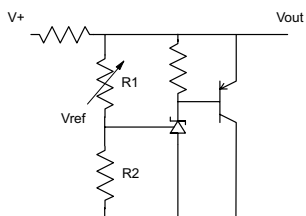

$$V_{out} = \left(1 + \frac{R1}{R2}\right) V_{ref}$$

HIGHER CURRENT SHUNT REGULATOR

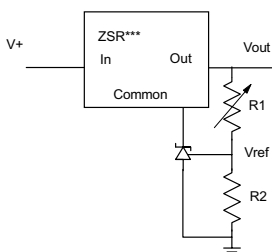

$$V_{out_MIN} = V_{ref} + V_{reg}$$

$$V_{out} = \left(1 + \frac{R1}{R2}\right) V_{ref}$$

OUTPUT CONTROL OF A THREE TERMINAL FIXED REGULATOR

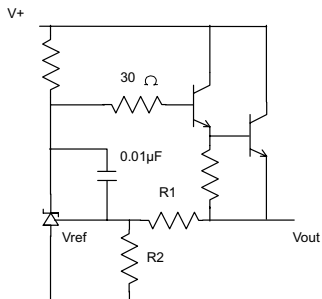

$$V_{out} = \left(1 + \frac{R1}{R2}\right) V_{ref}$$

SERIES REGULATOR

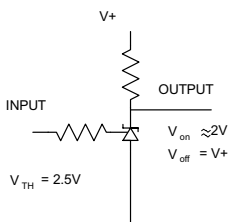

SINGLE SUPPLY COMPARATOR WITH TEMPERATURE COMPENSATED THRESHOLD

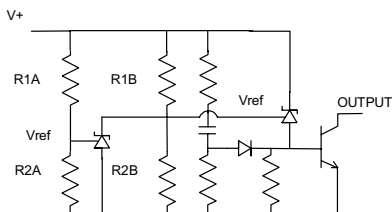

$$\text{Low limit} = \left(1 + \frac{R1B}{R2B}\right) V_{ref}$$

$$\text{High limit} = \left(1 + \frac{R1A}{R2A}\right) V_{ref}$$

OVER VOLTAGE / UNDER VOLTAGE PROTECTION CIRCUIT

ZH431

CONNECTION DIAGRAMS

SO8 Package Suffix – N8

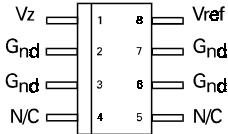

Top View

SOT223 Package Suffix – G

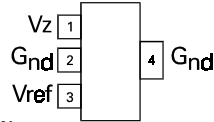

Top View –
Pin 4 floating or connected to pin 2

SOT23 Package Suffix – F

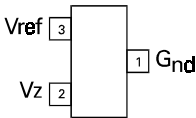

Top View

TO92 Package Suffix – C

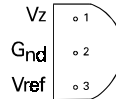

Bottom View

ORDERING INFORMATION

Part Number	Package	Tol. %	Part Mark
ZH431C01	TO92	1.0	ZH43101
ZH431C02	TO92	2.0	ZH43102
ZH431G01	SOT223	1.0	ZH43101
ZH431G02	SOT223	2.0	ZH43102
ZH431F01	SOT23	1.0	43H
ZH431F02	SOT23	2.0	43G
ZH431Z01	SOT89	1.0	43H
ZH431Z02	SOT89	2.0	43G
ZH431N801	SO8	1.0	ZH43101
ZH431N802	SO8	2.0	ZH43102

SOT89 Package Suffix – Z

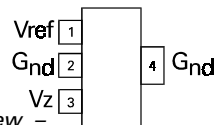

Top View –
Pin 4 floating or connected to pin 2