



Reset Circuit with Manual Reset

Description

The EM6325 is an ultra-low current reset circuit available in a large variety of configurations and very small packages for maximum flexibility in all end-applications up to 125°C and using power supplies between 1.5V and 5.5V.

This circuit monitors the supply voltage of any electronic system, and generates the appropriate reset signal after a fixed reset timeout period. The threshold defines the minimum allowed voltage which guarantees the good functionality of the system. When V_{DD} rises above V_{TH} , the output remains active for an additional delay time. This allows the system to stabilize before getting fully active.

This circuit features a Manual Reset: an input that asserts reset when pulled low (\overline{MR} with internal pull-up).

Small SC70-4L, SC70-5L and SOT23-5L packages as well as ultra-low supply current of 2.9µA make the EM6325 an ideal choice for portable and battery-operated devices.

Typical Application

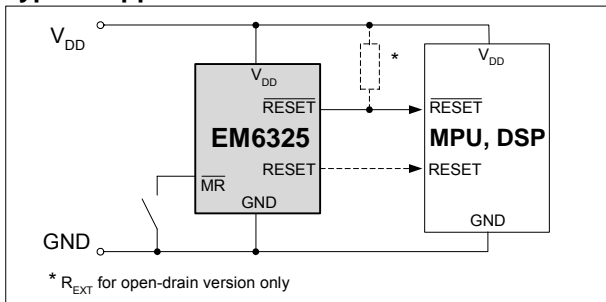

Block Diagram

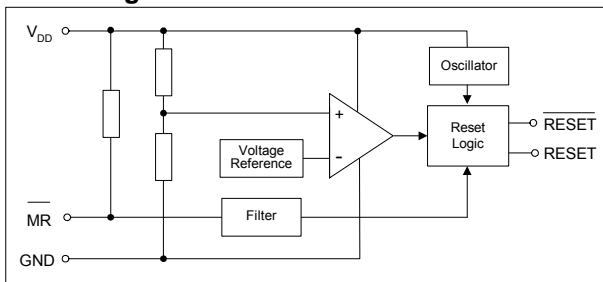

Features

- Manual reset function
- 200ms reset timeout period (1.6ms, 25ms, 1600ms on request)
- Ultra-low supply current of 2.9µA ($V_{DD}=3.3V$)
- Operating temperature range: -40°C to +125°C
- ±1.5% reset threshold accuracy
- 11 reset threshold voltages V_{TH} : 4.63V, 4.4V, 3.08V, 2.93V, 2.63V, 2.2V, 1.8V, 1.66V, 1.57V, 1.38V, 1.31V
- 3 reset output options:
 - Active-low \overline{RESETE} push-pull
 - Active-low \overline{RESETE} open-drain
 - Active-high RESETE push-pull
- Immune to short negative V_{DD} transients
- Guaranteed Reset valid down to 0.9V
- Threshold hysteresis: 2.1% of V_{TH}
- Very small SOT23-5L, SC70-5L and SC70-4L

Applications

- Computers
- Servers and workstations
- Modems
- Wireless communication
- Metering
- Playstations
- PDA , Webpad
- Automotive systems

Pin Configuration (top view)

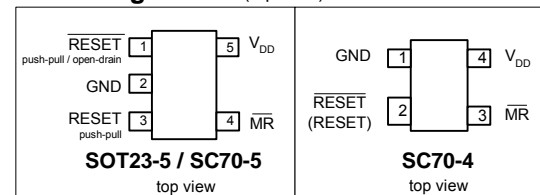

Pin Description

Pin		Name	Function
SOT23-5L / SC70-5L	SC70-4L		
1	2	\overline{RESETE}	Active-low \overline{RESETE} output. \overline{RESETE} remains low for the reset timeout period and then goes high after all reset conditions are deasserted or after \overline{MR} goes from low to high
2	1	GND	Ground
3	2	RESETE	Active-high RESETE output. RESETE remains high for the reset timeout period and then goes low after all reset conditions are deasserted or after \overline{MR} goes from low to high
4	3	\overline{MR}	Manual Reset input with an internal pull-up 15kΩ resistor. Reset remains active as long as \overline{MR} is low and for t_{POR} after \overline{MR} returns high. \overline{MR} can be driven with a CMOS output or shorted to ground with a switch
5	4	V_{DD}	Supply Voltage (5.5V max.)



Ordering Information

EM6325 C X SP5B - 2.9 +	
<p>Delay (t_{POR}): C = 200ms B = 25ms A = 1.6ms D = 1600ms</p>	<p>RoHS Compliance: + = lead-free/green mold compliant [blank] = leaded</p>
<p>Reset Output Type: X = Active-low /RES push-pull Active-high RES push-pull Y = Active-low /RES open-drain Active-high RES push-pull Z = Active-high RES push-pull</p>	<p>Reset Threshold Voltage (V_{TH}): 1.3 = 1.31V 2.6 = 2.63V 1.4 = 1.38V 2.9 = 2.93V 1.6 = 1.57V 3.1 = 3.08V 1.7 = 1.66V 4.4 = 4.40V 1.8 = 1.80V 4.6 = 4.63V 2.2 = 2.20V</p>
<p>Package: SP5B = SOT23-5, Tape&Reel 3000 pcs SC5B = SC70-5, Tape&Reel 3000 pcs SC4B = SC70-4, Tape&Reel 3000 pcs</p>	

Top Marking

Package top marking below is for most parts in leaded package (first letter is "A"). For lead-free/green mold (RoHS) parts, the first letter of top marking begins with letter "B" instead of letter "A". The underscore "_" refers to the four-letter code for the package (eg. SP5B, SC4B, ...).

Part Number	Top Marking	Part Number	Top Marking	Part Number	Top Marking	Part Number	Top Marking
EM6325AX -1.3	ANAA	EM6325BX -1.3	ANBA	EM6325CX -1.3	ANCA	EM6325DX -1.3	ANDA
EM6325AX -1.4	ANAB	EM6325BX -1.4	ANBB	EM6325CX -1.4	ANCB	EM6325DX -1.4	ANDB
EM6325AX -1.6	ANAC	EM6325BX -1.6	ANBC	EM6325CX -1.6	ANCC	EM6325DX -1.6	ANDC
EM6325AX -1.7	ANAD	EM6325BX -1.7	ANBD	EM6325CX -1.7	ANCD	EM6325DX -1.7	ANDD
EM6325AX -1.8	ANAE	EM6325BX -1.8	ANBE	EM6325CX -1.8	ANCE	EM6325DX -1.8	ANDE
EM6325AX -2.2	ANAF	EM6325BX -2.2	ANBF	EM6325CX -2.2	ANCF	EM6325DX -2.2	ANDF
EM6325AX -2.6	ANAG	EM6325BX -2.6	ANBG	EM6325CX -2.6	ANCG	EM6325DX -2.6	ANDG
EM6325AX -2.9	ANAH	EM6325BX -2.9	ANBH	EM6325CX -2.9	ANCH	EM6325DX -2.9	ANDH
EM6325AX -3.1	ANAJ	EM6325BX -3.1	ANBJ	EM6325CX -3.1	AN CJ	EM6325DX -3.1	ANDJ
EM6325AX -4.4	ANAK	EM6325BX -4.4	ANBK	EM6325CX -4.4	ANCK	EM6325DX -4.4	ANDK
EM6325AX -4.6	ANAL	EM6325BX -4.6	ANBL	EM6325CX -4.6	ANCL	EM6325DX -4.6	ANDL
EM6325AY -1.3	ANAM	EM6325BY -1.3	ANBM	EM6325CY -1.3	ANCM	EM6325DY -1.3	ANDM
EM6325AY -1.4	ANAN	EM6325BY -1.4	ANBN	EM6325CY -1.4	ANCN	EM6325DY -1.4	ANDN
EM6325AY -1.6	ANAP	EM6325BY -1.6	ANBP	EM6325CY -1.6	ANCP	EM6325DY -1.6	ANDP
EM6325AY -1.7	ANAQ	EM6325BY -1.7	ANBQ	EM6325CY -1.7	AN CQ	EM6325DY -1.7	ANDQ
EM6325AY -1.8	ANAR	EM6325BY -1.8	ANBR	EM6325CY -1.8	ANCR	EM6325DY -1.8	ANDR
EM6325AY -2.2	ANAS	EM6325BY -2.2	ANBS	EM6325CY -2.2	ANCS	EM6325DY -2.2	ANDS
EM6325AY -2.6	ANAT	EM6325BY -2.6	ANBT	EM6325CY -2.6	ANCT	EM6325DY -2.6	ANDT
EM6325AY -2.9	ANAU	EM6325BY -2.9	ANBU	EM6325CY -2.9	ANCU	EM6325DY -2.9	ANDU
EM6325AY -3.1	ANAV	EM6325BY -3.1	ANBV	EM6325CY -3.1	ANCV	EM6325DY -3.1	ANDV
EM6325AY -4.4	ANAW	EM6325BY -4.4	ANBW	EM6325CY -4.4	ANCW	EM6325DY -4.4	ANDW
EM6325AY -4.6	ANAX	EM6325BY -4.6	ANBX	EM6325CY -4.6	ANCX	EM6325DY -4.6	ANDX

Standard Versions, Samples

Sample stock is generally held on **standard versions** (below) only. Non standard versions have a 30,000 pieces minimum order quantity. Please contact factory for other versions not shown here and for availability of non standard versions.

EM6325AXSC4B-2.9
EM6325CXSC5B-2.9
EM6325CXSP5B-1.3
EM6325CXSP5B-2.6
EM6325CXSP5B-2.9
EM6325CXSP5B-3.1
EM6325CYSP5B-2.9
EM6325CYSP5B-4.6
EM6325DXSC4B-2.6
EM6325CXSP5B-4.6



Absolute Maximum Ratings

Parameter	Symbol	Conditions
Voltage at V_{DD} to GND	V_{DD}	-0.3V to +6V
Minimum voltage at any signal pin	V_{MIN}	GND - 0.3V
Maximum voltage at any signal pin	V_{MAX}	$V_{DD} + 0.3V$
Electrostatic discharge max. to MIL-STD-883C method 3015.7 with ref. to V_{SS}	V_{ESD}	2000V
Max. soldering conditions	T_{MAX}	250°C x 10s
Storage Temperature Range	T_{STG}	-65°C to +150°C

Stresses above these listed maximum ratings may cause permanent damages to the device. Exposure beyond specified operating conditions may affect device reliability or cause malfunction.

Handling Procedures

This device has built-in protection against high static voltages or electric fields; however, anti-static precautions must be taken as for any other CMOS component. Unless otherwise specified, proper operation can only occur when all terminal voltages are kept within the voltage range. Unused inputs must always be tied to a defined logic voltage level.

Operating Conditions

Parameter	Symbol	Min	Max	Unit
Supply voltage	V_{DD}	0.9	5.5	V
Operating Temperature	T_A	-40	+125	°C

Electrical Characteristics

Unless otherwise specified: $V_{DD} = 0.9V$ to $5.5V$, $T_A = -40°C$ to $+125°C$ (note 1).

Parameter	Symbol	Conditions	Min	Typ	Max	Unit		
Supply current (note 2)	I_{DD}	$V_{DD} = 1.5V$	+25°C	-	2.3	4.6		
			-40°C to +125°C	-		7		
		$V_{DD} = 3.3V$	+25°C	-	2.9	5.5		
			-40°C to +125°C	-		8.3		
		$V_{DD} = 5.0V$	+25°C	-	3.4	6.3		
			-40°C to +125°C	-		9.6		
Threshold voltage (note 3)	V_{TH}	EM6325 – 1.3	+25°C	1.290	1.31	1.330		
			-40°C to +85°C	1.245		1.382		
			-40°C to +125°C	1.221		1.387		
		EM6325 – 1.4	+25°C	1.359	1.38	1.401		
			-40°C to +85°C	1.311		1.456		
			-40°C to +125°C	1.286		1.461		
		EM6325 – 1.6	+25°C	1.546	1.57	1.594		
			-40°C to +85°C	1.492		1.656		
			-40°C to +125°C	1.463		1.663		
		EM6325 – 1.7	+25°C	1.635	1.66	1.685		
			-40°C to +85°C	1.577		1.751		
			-40°C to +125°C	1.547		1.758		
		EM6325 – 1.8	+25°C	1.773	1.80	1.827		
			-40°C to +85°C	1.710		1.899		
			-40°C to +125°C	1.678		1.906		
		EM6325 – 2.2	+25°C	2.167	2.20	2.233		
			-40°C to +85°C	2.090		2.321		
			-40°C to +125°C	2.050		2.330		
		EM6325 – 2.6	+25°C	2.591	2.63	2.669		
			-40°C to +85°C	2.499		2.775		
			-40°C to +125°C	2.451		2.785		
		EM6325 – 2.9	+25°C	2.886	2.93	2.974		
			-40°C to +85°C	2.784		3.091		
			-40°C to +125°C	2.731		3.103		
		EM6325 – 3.1	+25°C	3.034	3.08	3.126		
			-40°C to +85°C	2.926		3.249		
			-40°C to +125°C	2.871		3.262		
		EM6325 – 4.4	+25°C	4.334	4.40	4.466		
			-40°C to +85°C	4.180		4.642		
			-40°C to +125°C	4.101		4.660		
		EM6325 – 4.6	+25°C	4.561	4.63	4.699		
			-40°C to +85°C	4.399		4.885		
			-40°C to +125°C	4.315		4.903		
		Threshold hysteresis	V_{HYS}	$T_A = +25°C$	-	$2.1\% \cdot V_{TH}$	-	V

Note 1: Production tested at +25°C only. Over temperature limits are guaranteed by design, not production tested.

Note 3: Threshold voltage is specified for V_{DD} falling.



Electrical Characteristics (continued)

Unless otherwise specified: $V_{DD} = 0.9V$ to $5.5V$, $T_A = -40^\circ C$ to $+125^\circ C$ (note 1).

Parameter	Symbol	Conditions		Min	Typ	Max	Unit
Reset timeout period	t_{POR}	(note 2 and 4) V_{DD} from 0V to $V_{TH(typ)}+15\%$ $T_A = +25^\circ C$	EM6325C	155	200	224	ms
			EM6325A	0.7	1.6	3.8	
			EM6325B	19.4	25	28	
			EM6325D	1240	1600	1792	
Propagation delay time V_{DD} to \overline{RESET} (RESET) delay	t_p	V_{DD} drops from $V_{TH(typ)}+0.2V$ to $V_{TH(typ)}-0.2V$ (note 2). $T_A = +25^\circ C$		2	130	255	μs
Open-drain \overline{RESET} output Voltage	V_{OL}	$V_{DD} > 1V$	$I_{OL} = 100\mu A$	-	-	0.3	V
		$V_{DD} > 2.5V$	$I_{OL} = 1.5mA$	-	-	0.3	
		$V_{DD} > 5V$	$I_{OL} = 3mA$	-	-	0.35	
Push-pull \overline{RESET} / \overline{RESET} Output voltage	V_{OL}	$V_{DD} > 1V$	$I_{OL} = 100\mu A$	-	-	0.3	V
		$V_{DD} > 2.5V$	$I_{OL} = 1.5mA$	-	-	0.3	
		$V_{DD} > 5V$	$I_{OL} = 3mA$	-	-	0.35	
	V_{OH}	$V_{DD} > 1V$	$I_{OH} = -30\mu A$	0.8	-	-	
		$V_{DD} > 2.5V$	$I_{OH} = -1.5mA$	2	-	-	
		$V_{DD} > 5V$	$I_{OH} = -3mA$	4	-	-	
Output leakage current	I_{LEAK}	Only for EM6325_Y (open-drain)		-	-	0.5	μA
MANUAL RESET (MR)							
\overline{MR} Input low	$V_{MRT\ low}$	$T_A = +25^\circ C$				$0.3 \cdot V_{DD}$	V
\overline{MR} Input high	$V_{MRT\ high}$			$0.7 \cdot V_{DD}$			V
\overline{MR} to Reset delay	t_{MD}				0.3		μs
Pulse width at MR (note 5)	t_{PMD}			1			μs
\overline{MR} Internal Pull-up resistor	R_{MR}	$T_A = -40^\circ C$ to $+125^\circ C$		4.8	15	31	$k\Omega$

Note 1: Production tested at $+25^\circ C$ only. Over temperature limits are guaranteed by design, not production tested.

Note 2: \overline{RESET} (RESET) open.

Note 4: Standard version for t_{POR} is 200ms (typ), available at all times. Other option (1.6ms, 25ms, 1600ms) are available by mask option and upon minimum order quantity. Please contact EM sales.

Note 5: Pulse width must be greater than $1\mu s$ to ensure the \overline{RESET} (RESET) to go active.

Timing Waveforms

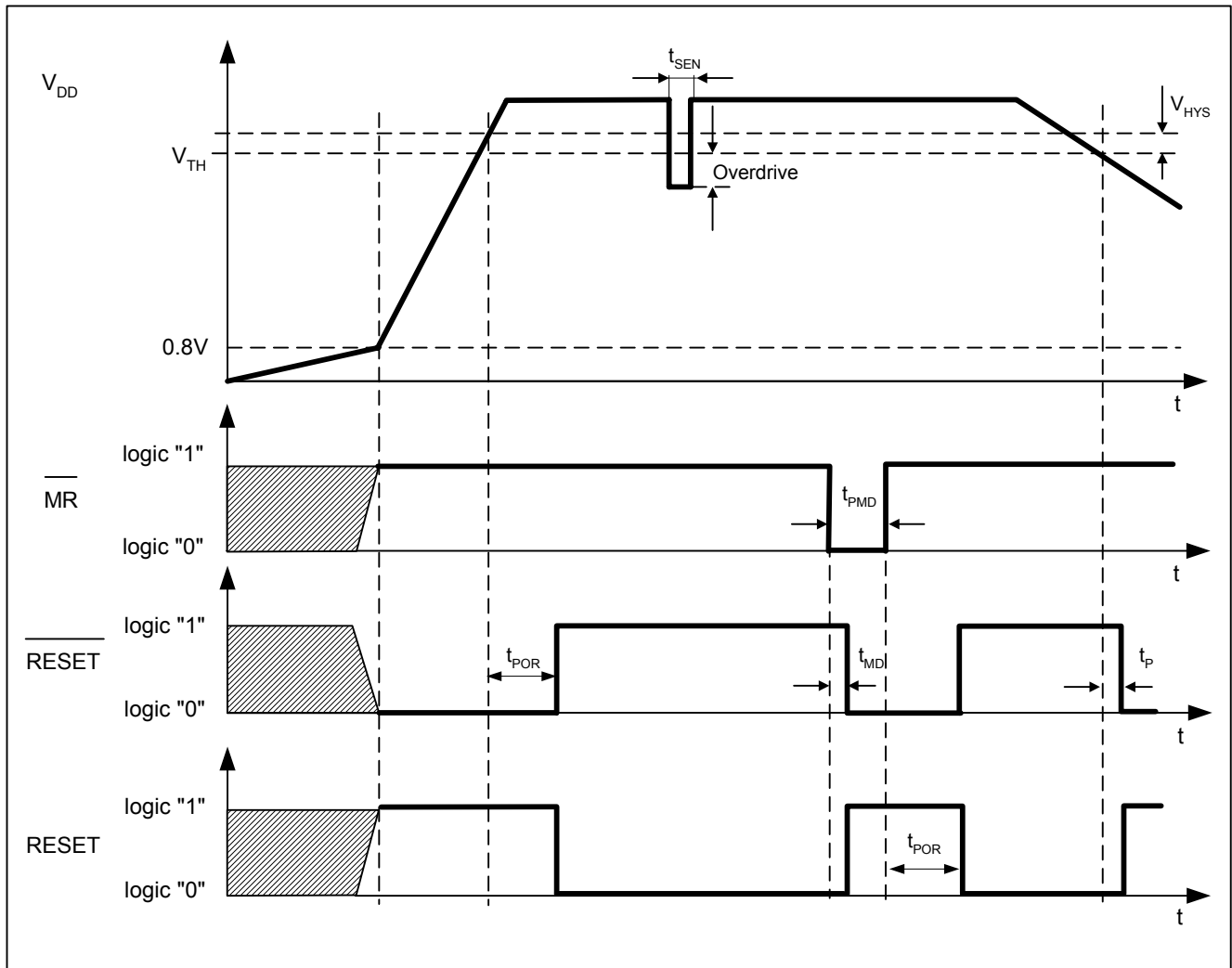

Note 6: t_{SEN} = Maximum Transient Duration. Please refer to figure on the next page.

Note 7: Overdrive = $V_{TH} - V_{DD}$. Please refer to figure on the next page.

Manual Reset Input

A logic low on \overline{MR} asserts a reset. Reset remains asserted while \overline{MR} is low, and for t_{POR} (200ms nominal for EM6325C) after it returns high. \overline{MR} has an internal 15k Ω pull-up resistor, so it can be left open if unused. This input can be driven with CMOS logic levels or with open-drain outputs. Connect a normally open momentary switch from \overline{MR} to V_{SS} to create a manual-reset function; debounce circuitry is integrated. If \overline{MR} is driven from long cable or the device is used in a noisy environment, connect a 0.1 μ F capacitor from \overline{MR} to V_{SS} to provide additional noise immunity (stronger external additional pull-up resistor can also be added).



Typical Operating Characteristics

(Typical values are at $T_A=+25^\circ\text{C}$ unless otherwise noted, $\overline{\text{MR}}$, $\overline{\text{RESET}}$ and RESET open.)

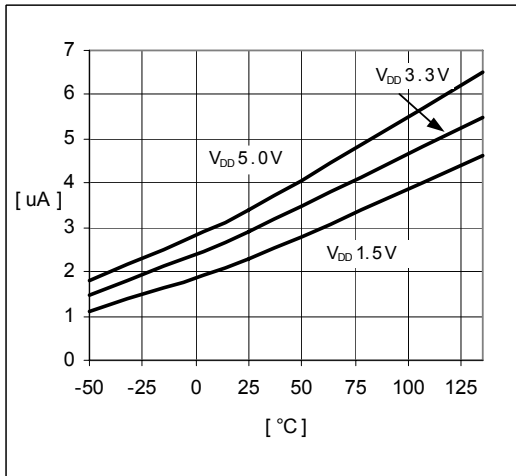

I_{DD} vs. Temperature

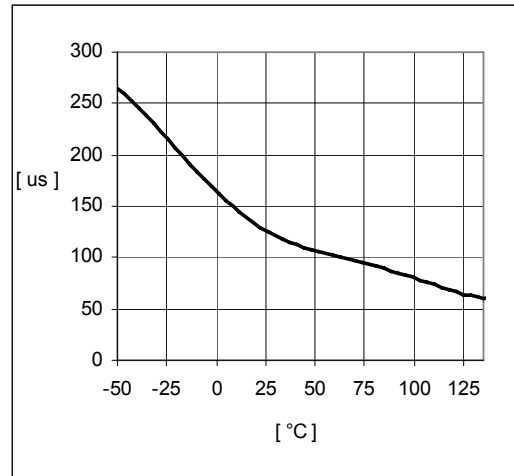

Propagation Time t_P vs. Temperature

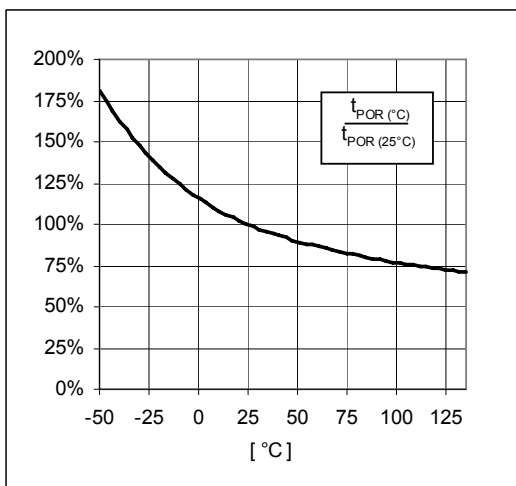

Reset Timeout Period t_{POR} vs. Temperature (normalized with respect to $t_{POR} 25^\circ\text{C}$)

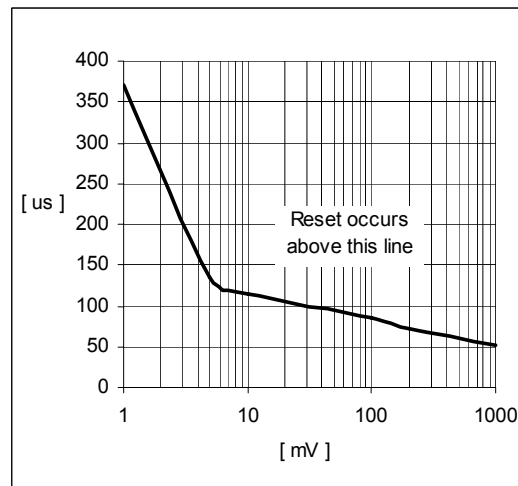

Maximum Transient Duration t_{SEN} vs. Overdrive $V_{TH} - V_{DD}$

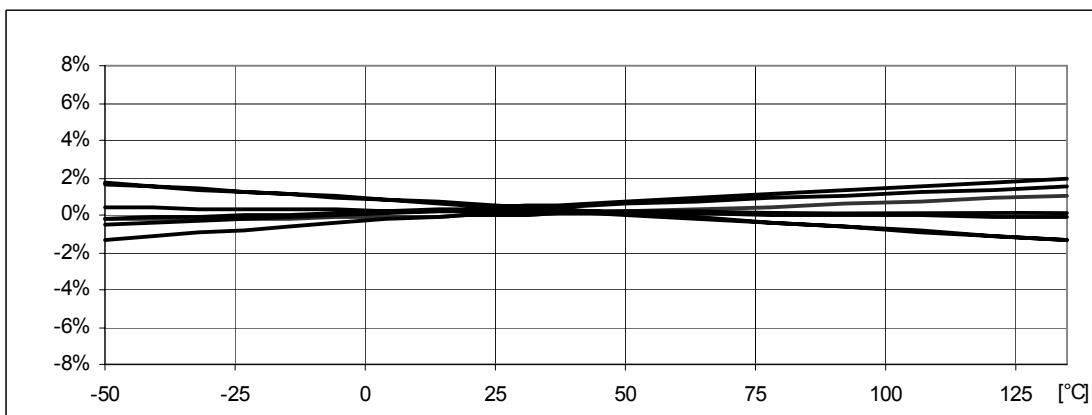

Threshold Voltage Variation vs. Temperature (normalized)

Package Information

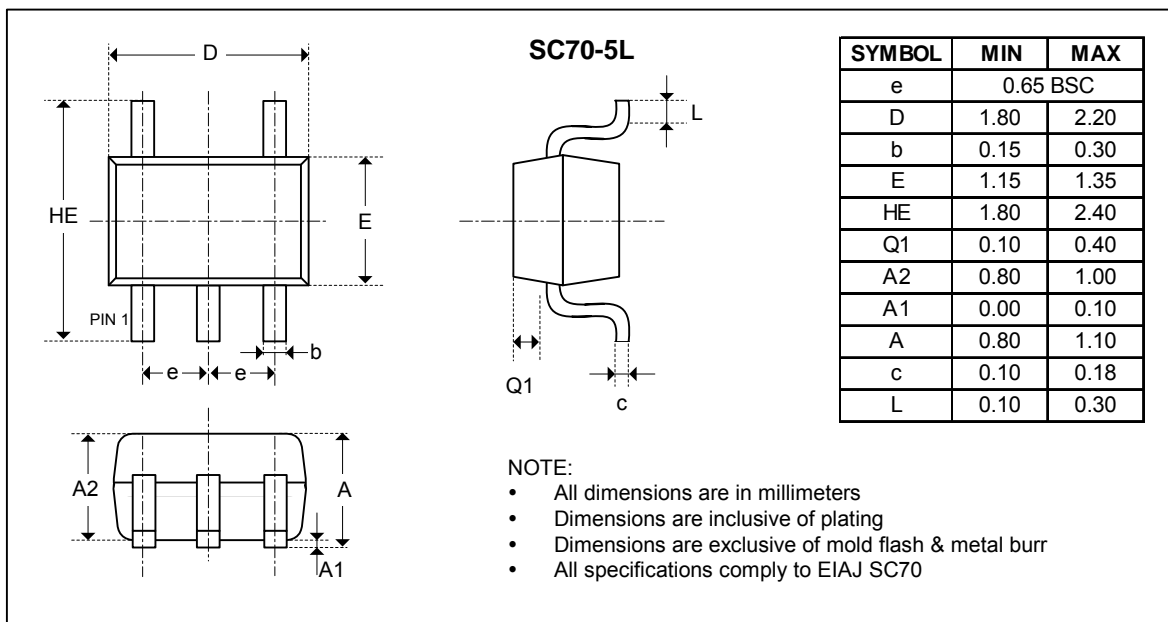
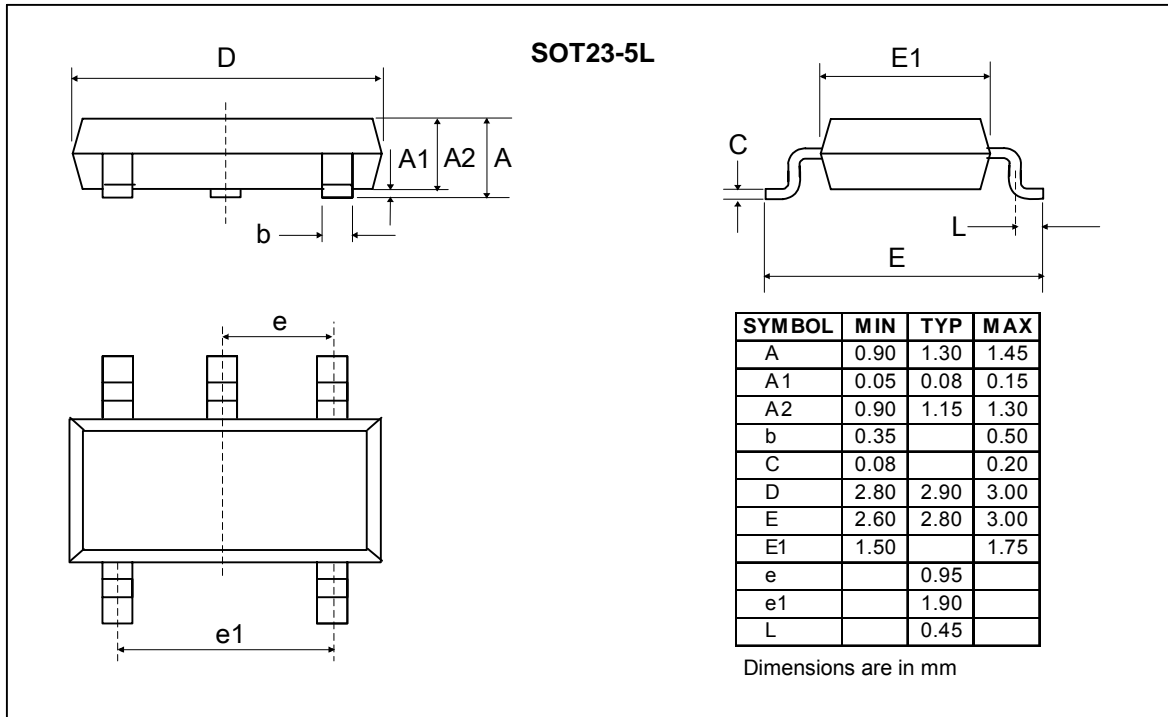

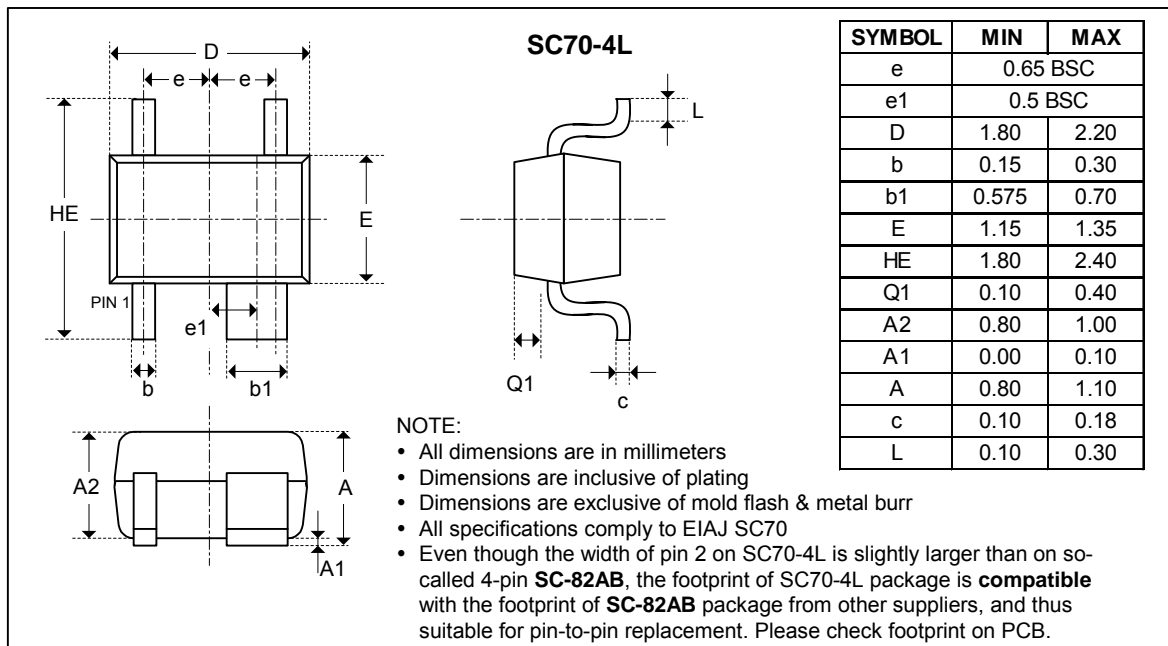

Traceability for small packages

Due to the limited space on the package surface, the bottom marking contains a limited number of characters that provide only partial information for lot traceability. Full information for complete traceability is however provided on the packing labels of the product at delivery from EM. It is highly recommended that the customer insures full lot traceability of EM product in his final product.

EM Microelectronic-Marin SA (EM) makes no warranty for the use of its products, other than those expressly contained in the Company's standard warranty which is detailed in EM's General Terms of Sale located on the Company's web site. EM assumes no responsibility for any errors which may appear in this document, reserves the right to change devices or specifications detailed herein at any time without notice, and does not make any commitment to update the information contained herein. No licenses to patents or other intellectual property of EM are granted in connection with the sale of EM products, expressly or by implications. EM's products are not authorized for use as components in life support devices or systems.

Product qualification is performed according to internal EM quality standards for industrial products. For any special requirement (eg. automotive grade) please contact EM Microelectronic-Marin S.A.

© EM Microelectronic-Marin SA, 05/05, Rev. I