

# 2N6504 Series

Preferred Device

## Silicon Controlled Rectifiers

### Reverse Blocking Thyristors

Designed primarily for half-wave ac control applications, such as motor controls, heating controls and power supply crowbar circuits.

#### Features

- Glass Passivated Junctions with Center Gate Fire for Greater Parameter Uniformity and Stability
- Small, Rugged, Thermowatt Constructed for Low Thermal Resistance, High Heat Dissipation and Durability
- Blocking Voltage to 800 Volts
- 300 A Surge Current Capability
- Pb-Free Packages are Available\*



**ON Semiconductor®**

<http://onsemi.com>

**SCRs**  
**25 AMPERES RMS**  
**50 thru 800 VOLTS**

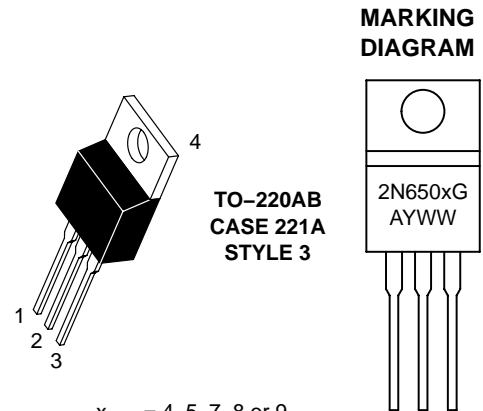
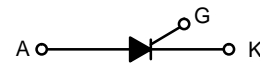

**TO-220AB**  
**CASE 221A**  
**STYLE 3**

x = 4, 5, 7, 8 or 9  
A = Assembly Location  
Y = Year  
WW = Work Week  
G = Pb-Free Device

#### PIN ASSIGNMENT

PIN ASSIGNMENT	
1	Cathode
2	Anode
3	Gate
4	Anode

#### ORDERING INFORMATION

See detailed ordering and shipping information in the package dimensions section on page 6 of this data sheet.

**Preferred** devices are recommended choices for future use and best overall value.

\*For additional information on our Pb-Free strategy and soldering details, please download the ON Semiconductor Soldering and Mounting Techniques Reference Manual, SOLDERRM/D.

## 2N6504 Series

### MAXIMUM RATINGS (T<sub>J</sub> = 25°C unless otherwise noted)

Rating	Symbol	Value	Unit
*Peak Repetitive Off-State Voltage (Note 1) (Gate Open, Sine Wave 50 to 60 Hz, T <sub>J</sub> = 25 to 125°C) 2N6504 2N6505 2N6507 2N6508 2N6509	V <sub>DRM</sub> , V <sub>RPM</sub>	50 100 400 600 800	V
On-State Current RMS (180° Conduction Angles; T <sub>C</sub> = 85°C)	I <sub>T(RMS)</sub>	25	A
Average On-State Current (180° Conduction Angles; T <sub>C</sub> = 85°C)	I <sub>T(AV)</sub>	16	A
Peak Non-repetitive Surge Current (1/2 Cycle, Sine Wave 60 Hz, T <sub>J</sub> = 100°C)	I <sub>TSM</sub>	250	A
Forward Peak Gate Power (Pulse Width ≤ 1.0 μs, T <sub>C</sub> = 85°C)	P <sub>GM</sub>	20	W
Forward Average Gate Power (t = 8.3 ms, T <sub>C</sub> = 85°C)	P <sub>G(AV)</sub>	0.5	W
Forward Peak Gate Current (Pulse Width ≤ 1.0 μs, T <sub>C</sub> = 85°C)	I <sub>GM</sub>	2.0	A
Operating Junction Temperature Range	T <sub>J</sub>	-40 to +125	°C
Storage Temperature Range	T <sub>stg</sub>	-40 to +150	°C

Maximum ratings are those values beyond which device damage can occur. Maximum ratings applied to the device are individual stress limit values (not normal operating conditions) and are not valid simultaneously. If these limits are exceeded, device functional operation is not implied, damage may occur and reliability may be affected.

- V<sub>DRM</sub> and V<sub>RPM</sub> for all types can be applied on a continuous basis. Ratings apply for zero or negative gate voltage; however, positive gate voltage shall not be applied concurrent with negative potential on the anode. Blocking voltages shall not be tested with a constant current source such that the voltage ratings of the devices are exceeded.

### THERMAL CHARACTERISTICS

Characteristic	Symbol	Max	Unit
*Thermal Resistance, Junction-to-Case	R <sub>θJC</sub>	1.5	°C/W
*Maximum Lead Temperature for Soldering Purposes 1/8 in from Case for 10 Seconds	T <sub>L</sub>	260	°C

### ELECTRICAL CHARACTERISTICS (T<sub>C</sub> = 25°C unless otherwise noted.)

Characteristic	Symbol	Min	Typ	Max	Unit
----------------	--------	-----	-----	-----	------

### OFF CHARACTERISTICS

*Peak Repetitive Forward or Reverse Blocking Current (V <sub>AK</sub> = Rated V <sub>DRM</sub> or V <sub>RPM</sub> , Gate Open)	I <sub>DRM</sub> , I <sub>RRM</sub>	-	-	10	μA
T <sub>J</sub> = 25°C					
T <sub>J</sub> = 125°C		-	-	2.0	mA

### ON CHARACTERISTICS

*Forward On-State Voltage (Note 2) (I <sub>TM</sub> = 50 A)	V <sub>TM</sub>	-	-	1.8	V
*Gate Trigger Current (Continuous dc) (V <sub>AK</sub> = 12 Vdc, R <sub>L</sub> = 100 Ω)	I <sub>GT</sub>	-	9.0	30	mA
T <sub>C</sub> = 25°C					
T <sub>C</sub> = -40°C		-	-	75	
*Gate Trigger Voltage (Continuous dc) (V <sub>AK</sub> = 12 Vdc, R <sub>L</sub> = 100 Ω, T <sub>C</sub> = -40°C)	V <sub>GT</sub>	-	1.0	1.5	V
Gate Non-Trigger Voltage (V <sub>AK</sub> = 12 Vdc, R <sub>L</sub> = 100 Ω, T <sub>J</sub> = 125°C)	V <sub>GD</sub>	0.2	-	-	V
*Holding Current (V <sub>AK</sub> = 12 Vdc, Initiating Current = 200 mA, Gate Open)	I <sub>H</sub>	-	18	40	mA
T <sub>C</sub> = 25°C					
T <sub>C</sub> = -40°C		-	-	80	
*Turn-On Time (I <sub>TM</sub> = 25 A, I <sub>GT</sub> = 50 mAdc)	t <sub>gt</sub>	-	1.5	2.0	μs
Turn-Off Time (V <sub>DRM</sub> = rated voltage) (I <sub>TM</sub> = 25 A, I <sub>R</sub> = 25 A) (I <sub>TM</sub> = 25 A, I <sub>R</sub> = 25 A, T <sub>J</sub> = 125°C)	t <sub>q</sub>	-	15	-	μs
		-	35	-	

### DYNAMIC CHARACTERISTICS

Critical Rate of Rise of Off-State Voltage (Gate Open, Rated V <sub>DRM</sub> , Exponential Waveform)	dv/dt	-	50	-	V/μs
---	-------	---	----	---	------

\*Indicates JEDEC Registered Data.

- Pulse Test: Pulse Width ≤ 300 μs, Duty Cycle ≤ 2%.

# 2N6504 Series

## Voltage Current Characteristic of SCR

Symbol	Parameter
$V_{DRM}$	Peak Repetitive Off State Forward Voltage
$I_{DRM}$	Peak Forward Blocking Current
$V_{RRM}$	Peak Repetitive Off State Reverse Voltage
$I_{RRM}$	Peak Reverse Blocking Current
$V_{TM}$	Peak On State Voltage
$I_H$	Holding Current

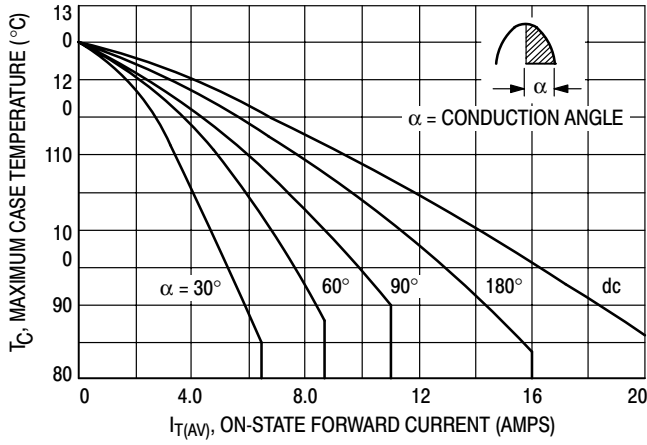
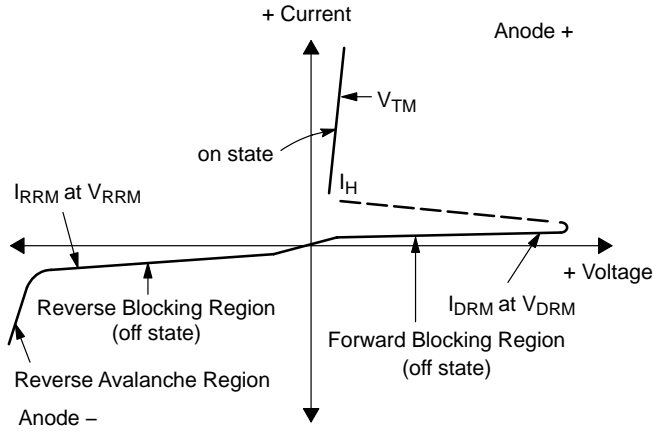

Figure 1. Average Current Derating

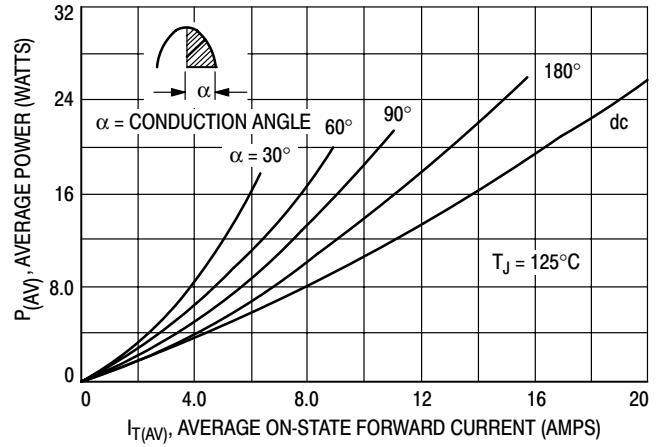

Figure 2. Maximum On-State Power Dissipation

# 2N6504 Series

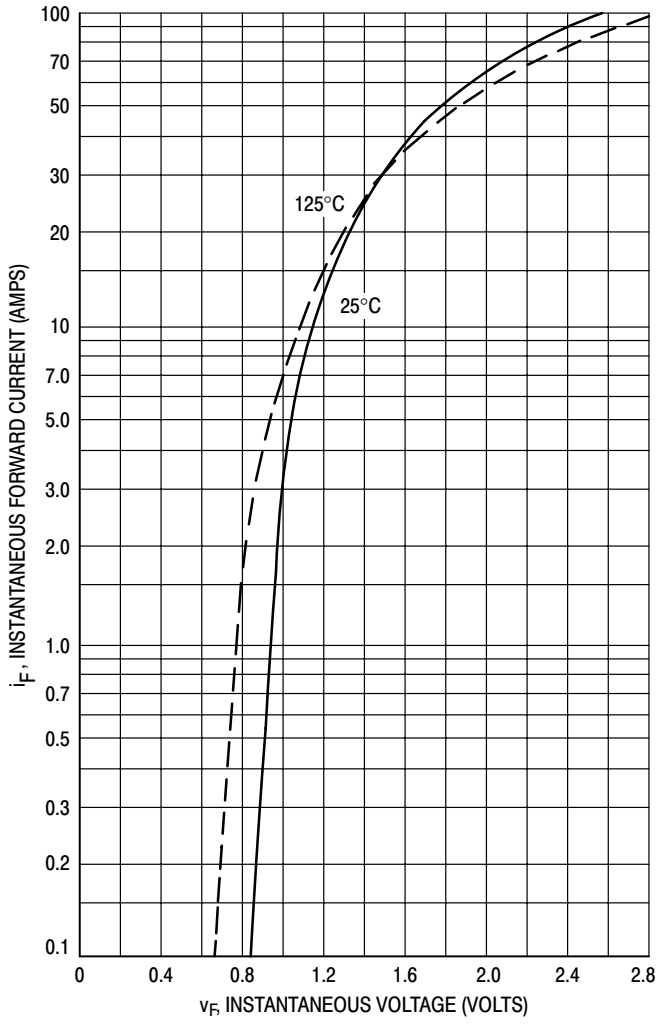

Figure 3. Typical On-State Characteristics

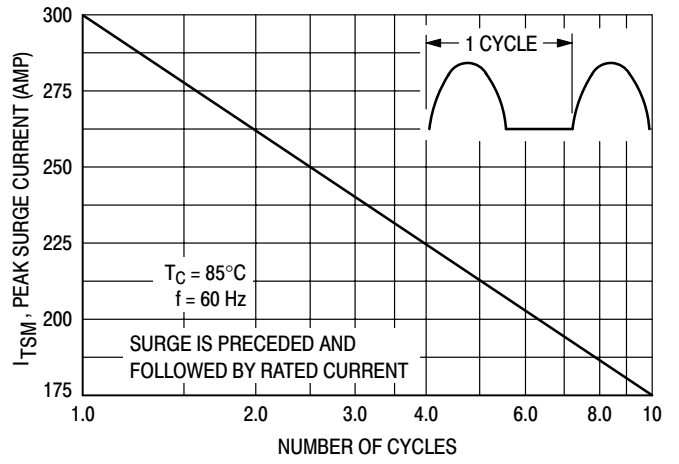

Figure 4. Maximum Non-Repetitive Surge Current

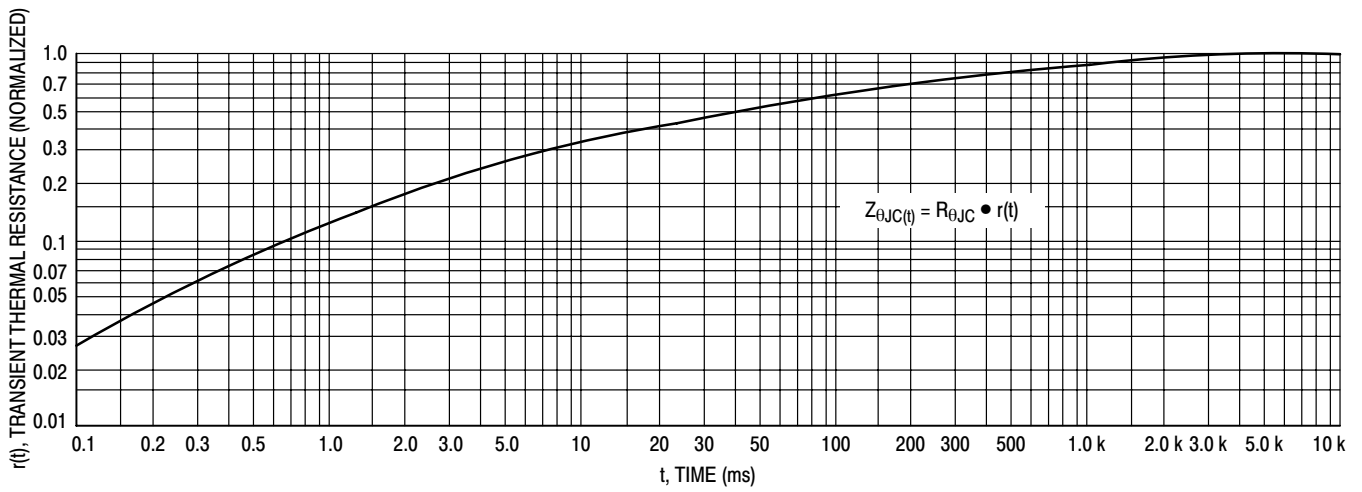

Figure 5. Thermal Response

# 2N6504 Series

## TYPICAL TRIGGER CHARACTERISTICS

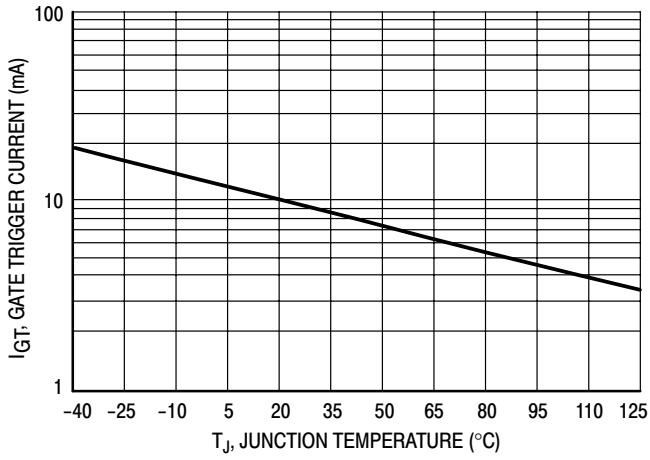

Figure 6. Typical Gate Trigger Current versus Junction Temperature

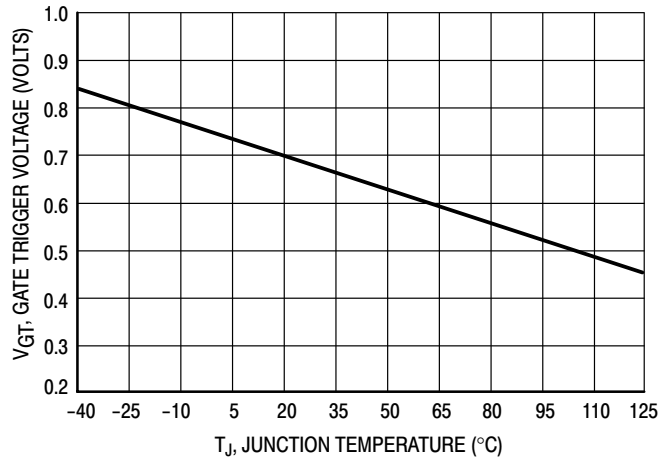

Figure 7. Typical Gate Trigger Voltage versus Junction Temperature

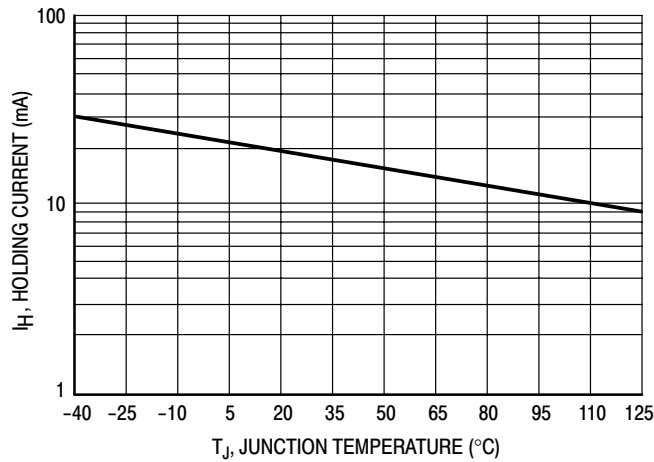

Figure 8. Typical Holding Current versus Junction Temperature

## 2N6504 Series

### ORDERING INFORMATION

Device	Package	Shipping
2N6504	TO-220AB	500 Units / Box
2N6504G	TO-220AB (Pb-Free)	
2N6505	TO-220AB	
2N6505G	TO-220AB (Pb-Free)	
2N6505T	TO-220AB	
2N6505TG	TO-220AB (Pb-Free)	
2N6507	TO-220AB	
2N6507G	TO-220AB (Pb-Free)	
2N6507T	TO-220AB	
2N6507TG	TO-220AB (Pb-Free)	
2N6508	TO-220AB	
2N6508G	TO-220AB (Pb-Free)	
2N6509	TO-220AB	
2N6509G	TO-220AB (Pb-Free)	
2N6509T	TO-220AB	
2N6509TG	TO-220AB (Pb-Free)	

# 2N6504 Series

## PACKAGE DIMENSIONS

TO-220AB  
CASE 221A-09  
ISSUE AA

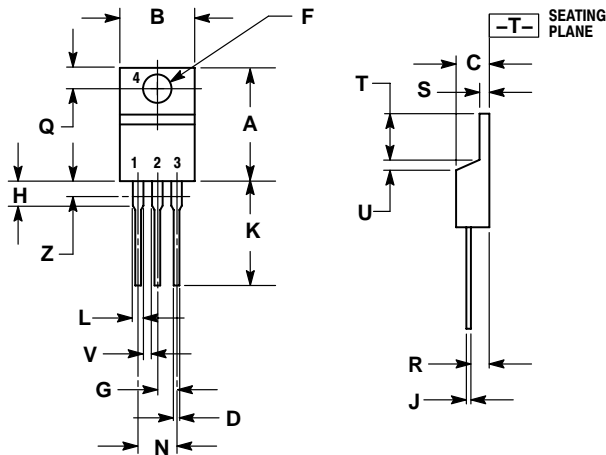

**NOTES:**

1. DIMENSIONING AND TOLERANCING PER ANSI Y14.5M, 1982.
2. CONTROLLING DIMENSION: INCH.
3. DIMENSION Z DEFINES A ZONE WHERE ALL BODY AND LEAD IRREGULARITIES ARE ALLOWED.

DIM	INCHES		MILLIMETERS	
	MIN	MAX	MIN	MAX
A	0.570	0.620	14.48	15.75
B	0.380	0.405	9.66	10.28
C	0.160	0.190	4.07	4.82
D	0.025	0.035	0.64	0.88
F	0.142	0.147	3.61	3.73
G	0.095	0.105	2.42	2.66
H	0.110	0.155	2.80	3.93
J	0.018	0.025	0.46	0.64
K	0.500	0.562	12.70	14.27
L	0.045	0.060	1.15	1.52
N	0.190	0.210	4.83	5.33
Q	0.100	0.120	2.54	3.04
R	0.080	0.110	2.04	2.79
S	0.045	0.055	1.15	1.39
T	0.235	0.255	5.97	6.47
U	0.000	0.050	0.00	1.27
V	0.045	---	1.15	---
Z	---	0.080	---	2.04

**STYLE 3:**

1. CATHODE
2. ANODE
3. GATE
4. ANODE

ON Semiconductor and are registered trademarks of Semiconductor Components Industries, LLC (SCILLC). SCILLC reserves the right to make changes without further notice to any products herein. SCILLC makes no warranty, representation or guarantee regarding the suitability of its products for any particular purpose, nor does SCILLC assume any liability arising out of the application or use of any product or circuit, and specifically disclaims any and all liability, including without limitation special, consequential or incidental damages. "Typical" parameters which may be provided in SCILLC data sheets and/or specifications can and do vary in different applications and actual performance may vary over time. All operating parameters, including "Typicals" must be validated for each customer application by customer's technical experts. SCILLC does not convey any license under its patent rights nor the rights of others. SCILLC products are not designed, intended, or authorized for use as components in systems intended for surgical implant into the body, or other applications intended to support or sustain life, or for any other application in which the failure of the SCILLC product could create a situation where personal injury or death may occur. Should Buyer purchase or use SCILLC products for any such unintended or unauthorized application, Buyer shall indemnify and hold SCILLC and its officers, employees, subsidiaries, affiliates, and distributors harmless against all claims, costs, damages, and expenses, and reasonable attorney fees arising out of, directly or indirectly, any claim of personal injury or death associated with such unintended or unauthorized use, even if such claim alleges that SCILLC was negligent regarding the design or manufacture of the part. SCILLC is an Equal Opportunity/Affirmative Action Employer. This literature is subject to all applicable copyright laws and is not for resale in any manner.

### PUBLICATION ORDERING INFORMATION

**LITERATURE FULFILLMENT:**  
Literature Distribution Center for ON Semiconductor  
P.O. Box 61312, Phoenix, Arizona 85082-1312 USA  
**Phone:** 480-829-7710 or 800-344-3860 Toll Free USA/Canada  
**Fax:** 480-829-7709 or 800-344-3867 Toll Free USA/Canada  
**Email:** orderlit@onsemi.com

**N. American Technical Support:** 800-282-9855 Toll Free USA/Canada

**Japan:** ON Semiconductor, Japan Customer Focus Center  
2-9-1 Kamimeguro, Meguro-ku, Tokyo, Japan 153-0051  
**Phone:** 81-3-5773-3850

**ON Semiconductor Website:** <http://onsemi.com>

**Order Literature:** <http://www.onsemi.com/litorder>

For additional information, please contact your local Sales Representative.