



Ultrahigh-Speed Switching Applications

Features

- Low ON resistance.
- Ultrahigh-speed switching.
- Low-voltage drive (2.5V drive).

Package Dimensions

unit: mm

2062A-PCP

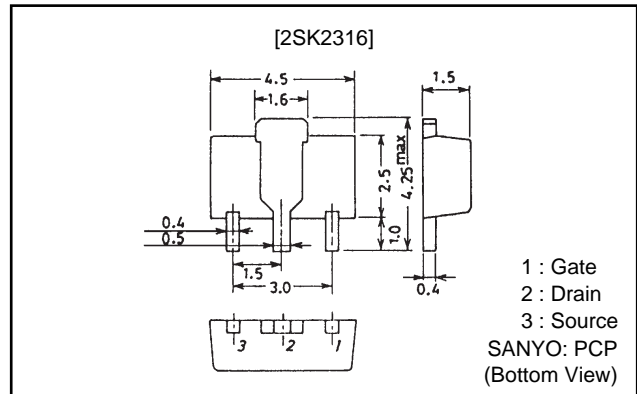

Specifications

Absolute Maximum Ratings at Ta=25°C

Parameter	Symbol	Conditions	Ratings	Unit
Drain-to-Source Voltage	V _{DSS}		20	V
Gate-to-Source Voltage	V _{GSS}		±10	V
Drain Current (DC)	I _D		2	A
Drain Current (Pulse)	I _{DP}	PW≤10μd, duty cycle≤1%	8	A
Allowable Power Dissipation	P _D	Mounted on ceramic board (250mm ² ×0.8mm)	1.5	W
		T _c =25°C	3.5	W
Channel Temperature	T _{ch}		150	°C
Storage Temperature	T _{stg}		-55 to +150	°C

Electrical Characteristics at Ta=25°C

Parameter	Symbol	Conditions	Ratings			Unit
			min	typ	max	
D-S Breakdown Voltage	V _{(BR)DSS}	I _D =1mA, V _{GS} =0	20			V
G-S Breakdown Voltage	V _{(BR)GSS}	I _G =±100μA, V _{DS} =0	±10			V
Zero-Gate Voltage Drain Current	I _{DSS}	V _{DS} =16V, V _{GS} =0			100	μA
Gate-to-Source Leakage Current	I _{GSS}	V _{GS} =±8V, V _{DS} =0			±10	μA
Cutoff Voltage	V _{GS(off)}	V _{DS} =10V, I _D =1mA	0.5		1.5	V
Forward Transfer Admittance	y _{fs}	V _{DS} =10V, I _D =1A	1.8	2.8		S
Static Drain-to-Source ON-State Resistance	R _{DS(on)}	I _D =1A, V _{GS} =4V		140	200	mΩ
ON-State Resistance	R _{DS(on)}	I _D =1A, V _{GS} =2.5V		200	320	mΩ
Input Capacitance	C _{iss}	V _{DS} =10V, f=1MHz		170		pF
Output Capacitance	C _{oss}	V _{DS} =10V, f=1MHz		145		pF
Reverse Transfer Capacitance	C _{rss}	V _{DS} =10V, f=1MHz		50		pF

Continued on next page.

Continued from preceding page.

Parameter	Symbol	Conditions	Ratings			Unit
			min	typ	max	
Turn-ON Delay Time	$t_{d(on)}$	See specified Test Circuit.		15		ns
Rise Time	t_r	"		20		ns
Turn-OFF Delay Time	$t_{d(off)}$	"		50		ns
Fall Time	t_f	"		35		ns
Diode Forward Voltage	V_{SD}	$I_S=2A, V_{GS}=0$		1.0		V

Making : KP

Switching Time Test Circuit

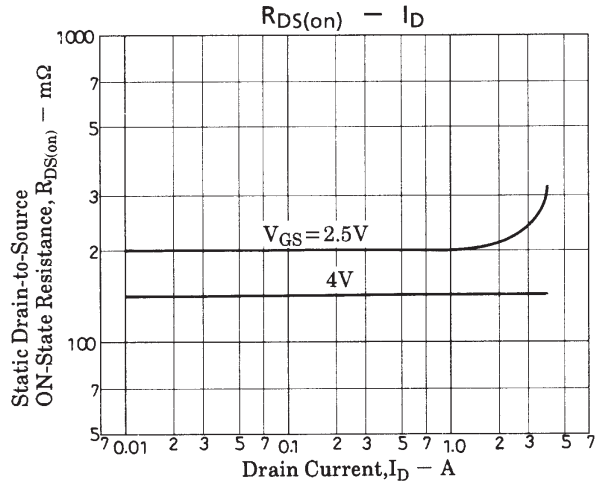
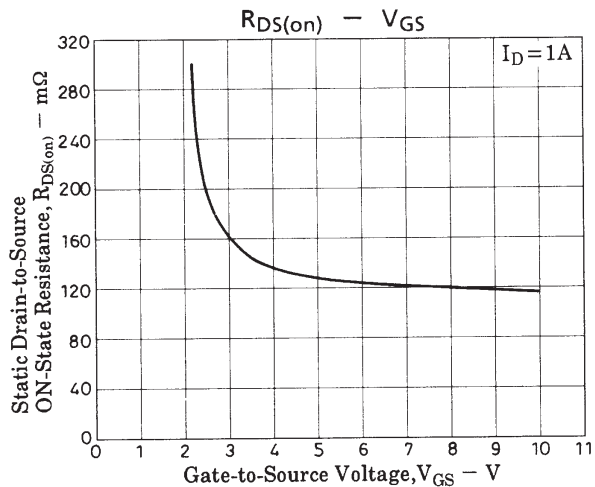
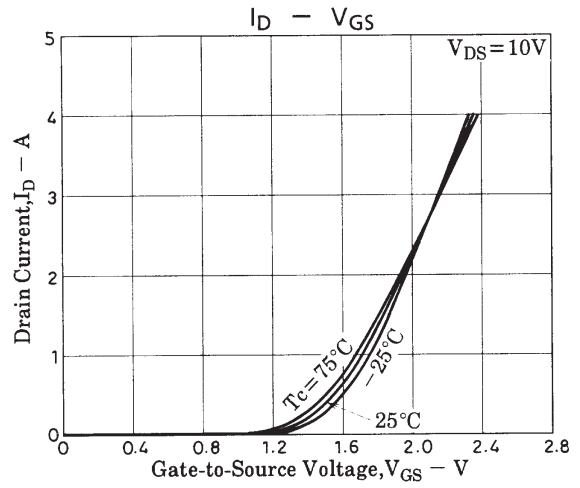
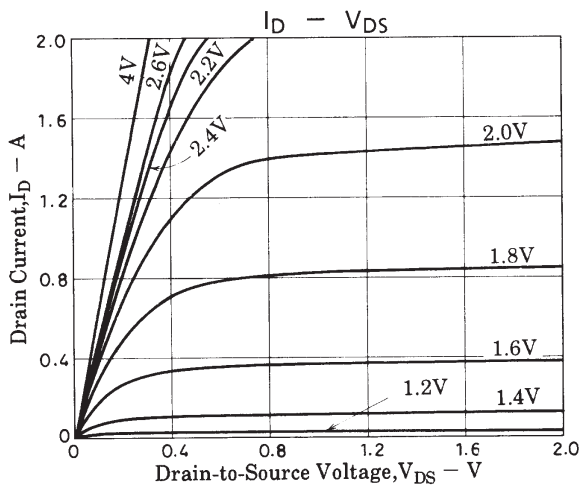
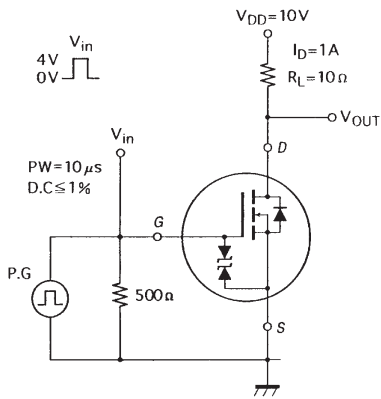

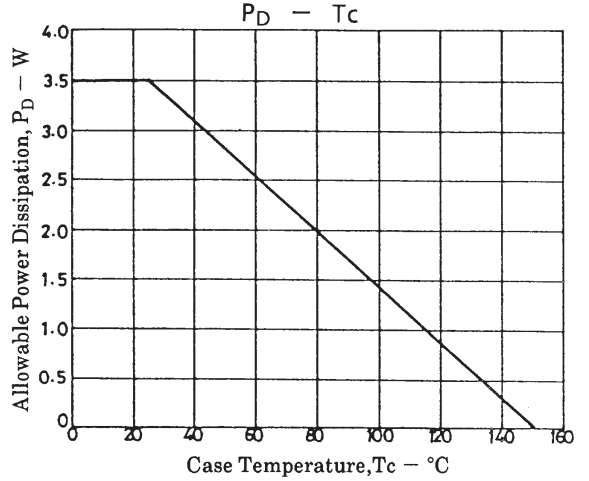
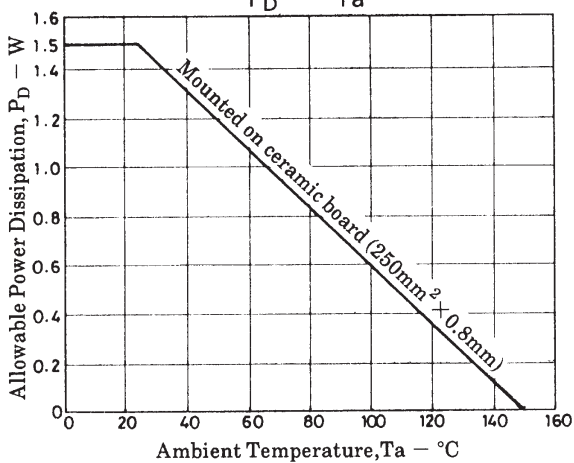
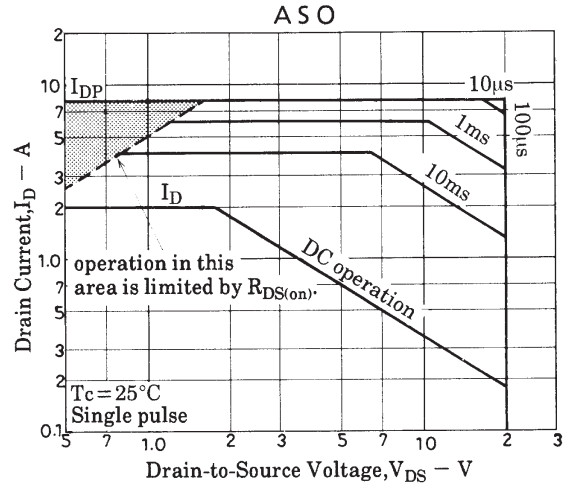
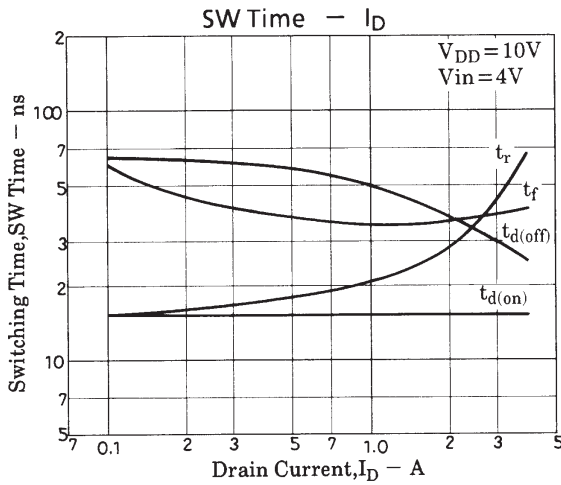
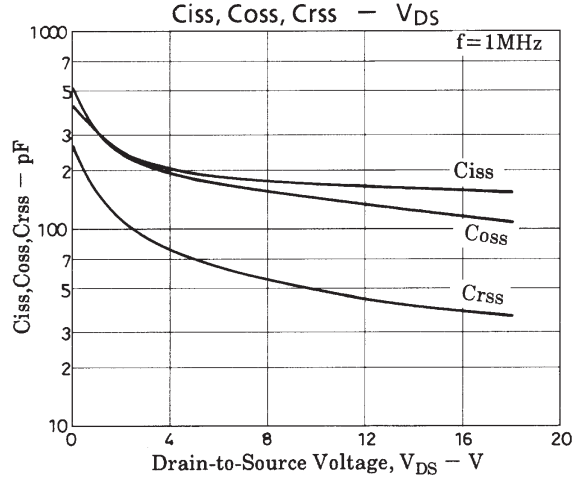
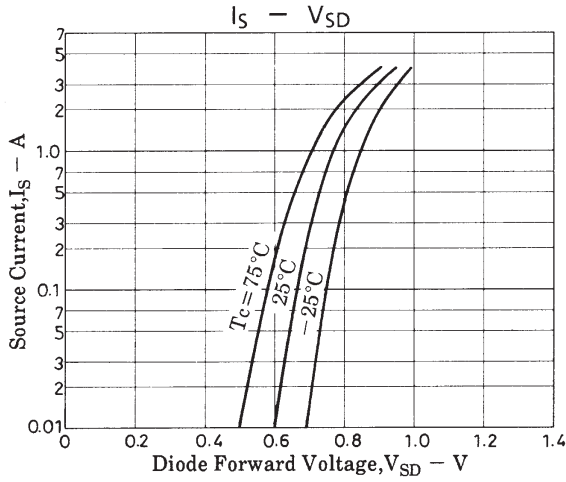
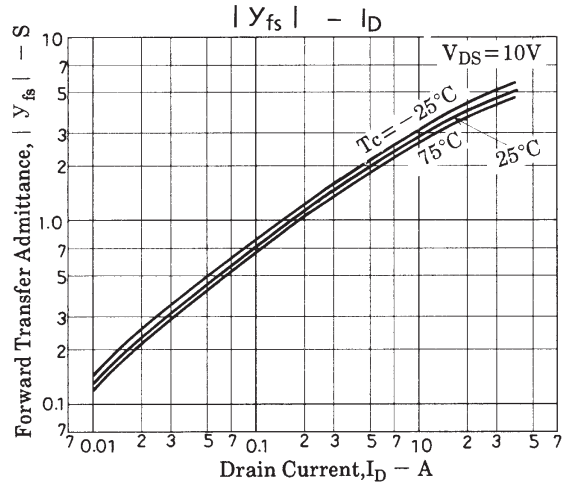
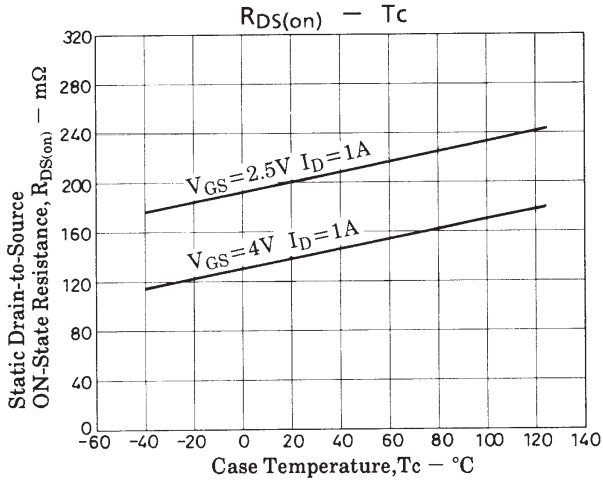

- No products described or contained herein are intended for use in surgical implants, life-support systems, aerospace equipment, nuclear power control systems, vehicles, disaster/crime-prevention equipment and the like, the failure of which may directly or indirectly cause injury, death or property loss.
- Anyone purchasing any products described or contained herein for an above-mentioned use shall:
 - ① Accept full responsibility and indemnify and defend SANYO ELECTRIC CO., LTD., its affiliates, subsidiaries and distributors and all their officers and employees, jointly and severally, against any and all claims and litigation and all damages, cost and expenses associated with such use:
 - ② Not impose any responsibility for any fault or negligence which may be cited in any such claim or litigation on SANYO ELECTRIC CO., LTD., its affiliates, subsidiaries and distributors or any of their officers and employees jointly or severally.
- Information (including circuit diagrams and circuit parameters) herein is for example only; it is not guaranteed for volume production. SANYO believes information herein is accurate and reliable, but no guarantees are made or implied regarding its use or any infringements of intellectual property rights or other rights of third parties.

This catalog provides information as of January, 1997. Specifications and information herein are subject to change without notice.