

3SK241

GaAs N-Channel MES FET

For VHF-UHF amplification

■ Features

- Low noise-figure (NF)
- Large power gain PG
- Mini-type package, allowing downsizing of the sets and automatic insertion through the tape/magazine packing.

■ Absolute Maximum Ratings (Ta = 25°C)

Parameter	Symbol	Ratings	Unit
Drain to Source voltage	V_{DS}	13	V
Gate 1 to Source voltage	V_{G1S}	-6	V
Gate 2 to Source voltage	V_{G2S}	-6	V
Drain current	I_D	50	mA
Gate 1 current	I_{G1}	1	mA
Gate 2 current	I_{G2}	1	mA
Allowable power dissipation	P_D	200	mW
Channel temperature	T_{ch}	150	°C
Storage temperature	T_{stg}	-55 to +150	°C

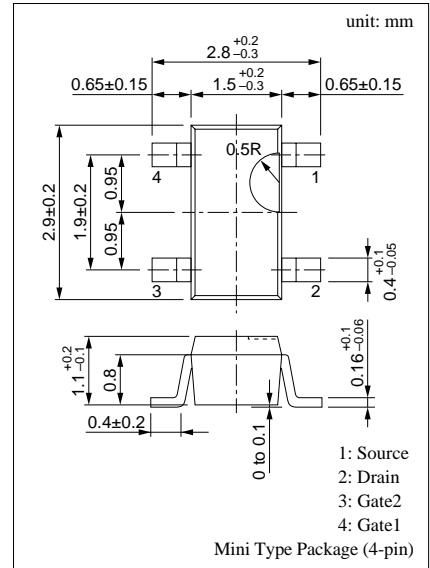

Marking Symbol: DU

■ Electrical Characteristics (Ta = 25°C)

Parameter	Symbol	Conditions	min	typ	max	Unit
Drain to Source cut-off current	I_{DSS}	$V_{DS} = 5V, V_{G1S} = 0, V_{G2S} = 0$	8.5		35	mA
Gate 2 to Drain current	I_{G2DO}	$V_{G2D} = -13V (G1, S = \text{Open})$			50	μA
Gate 1 cut-off current	I_{G1SS}	$V_{DS} = V_{G2S} = 0, V_{G1S} = -6V$			-20	μA
Gate 2 cut-off current	I_{G2SS}	$V_{DS} = V_{G1S} = 0, V_{G2S} = -6V$			-20	μA
Drain cut-off current	I_{DSX}	$V_{DS} = 13V, V_{G1S} = -3.5V, V_{G2S} = 0$			50	μA
Gate 1 to Source cut-off voltage	V_{G1SC}	$V_{DS} = 5V, V_{G2S} = 0, I_D = 200\mu A$			-3.5	V
Gate 2 to Source cut-off voltage	V_{G2SC}	$V_{DS} = 5V, V_{G1S} = 0, I_D = 200\mu A$			-3.5	V
Forward transfer admittance	$ Y_{fs} $	$V_{DS} = 5V, I_D = 10mA, V_{G2S} = 1.5V, f = 1kHz$	18	23		mS
Input capacitance (Common Source)	C_{iss}	$V_{DS} = 5V, V_{G1S} = V_{G2S} = -6V$ $f = 1MHz$		0.4	2	pF
Output capacitance (Common Source)	C_{oss}			0.3	1.2	pF
Reverse transfer capacitance (Common Source)	C_{rss}			0.02	0.04	pF
Power gain	PG	$V_{DS} = 5V, I_D = 10mA$	13	19		dB
Noise figure	NF	$V_{G2S} = 1.5V, f = 800MHz$		1.5	2.5	dB
Gain reduction	G_R	$V_{DS} = 5V, V_{AGC} = 1.5V/-3.5V, f = 800MHz$	37	45		dB

$P_D - T_a$

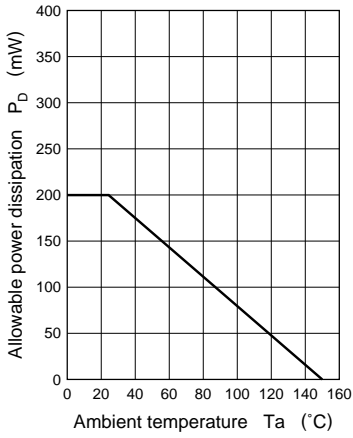

$I_D - V_{DS}$

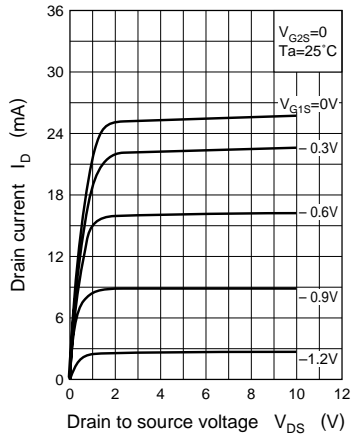

$I_D - V_{G1S}$

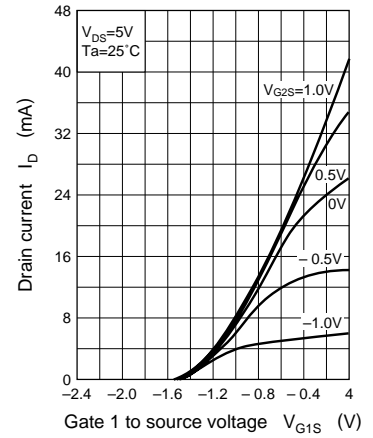

$I_D - V_{G2S}$

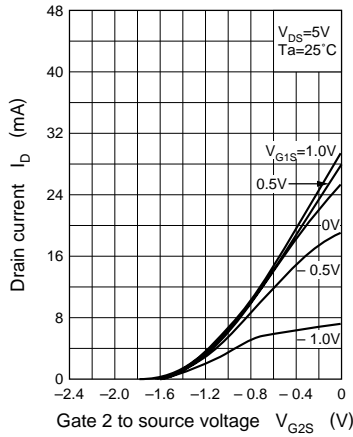

$|Y_{fs}| - V_{G1S}$

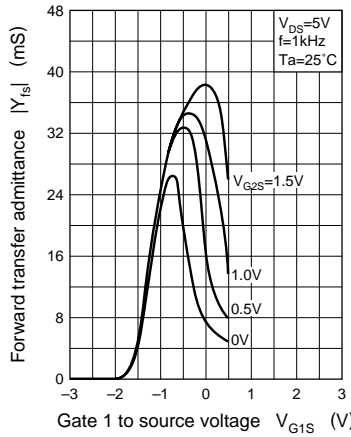

$C_{iss}, C_{oss} - V_{DS}$

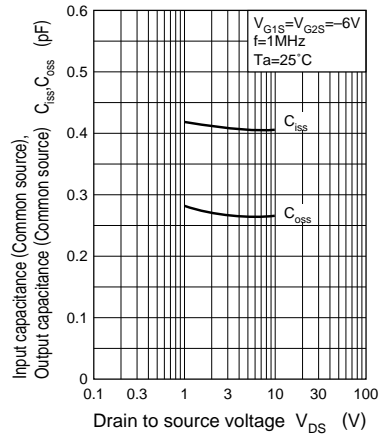

$PG - V_{G1S}$

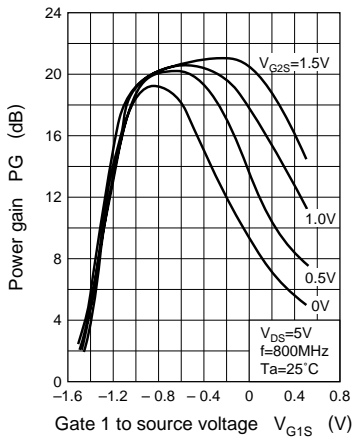

$NF - V_{G1S}$

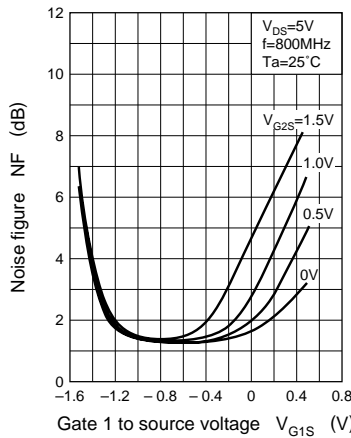

$PG - V_{G2S}$

