

### RESISTOR BUILT-IN TYPE PNP TRANSISTOR

#### FEATURES

- Compact package
- Resistors built-in type
- Complementary to KA4xxx

#### ORDERING INFORMATION

PART NUMBER	PACKAGE
KN4xxx	SC-75 (USM)

#### ABSOLUTE MAXIMUM RATINGS (T<sub>A</sub> = 25°C)

Collector to Base Voltage	V <sub>CB0</sub>	-60	V
Collector to Emitter Voltage	V <sub>CE0</sub>	-50	V
Emitter to Base Voltage	V <sub>EB0</sub>	-5	V
Collector Current (DC)	I <sub>C</sub>	-0.1	A
Collector Current (pulse) <sup>Note</sup>	I <sub>C(pulse)</sub>	-0.2	A
Total Power Dissipation	P <sub>T</sub>	0.15	W
Junction Temperature	T <sub>j</sub>	150	°C
Storage Temperature	T <sub>stg</sub>	-55 to +150	°C

**Note** PW ≤ 10 ms, Duty Cycle ≤ 50%

#### ★ PACKAGE DRAWING (Unit: mm)

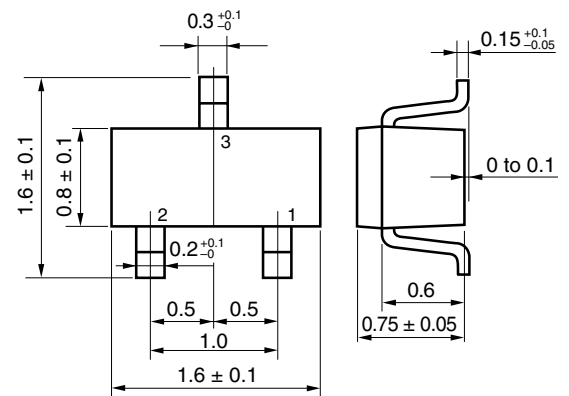

#### EQUIVALENT CIRCUIT

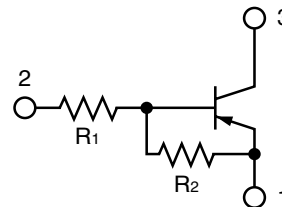

#### PIN CONNECTION

- 1: Emitter
- 2: Base
- 3: Collector

PART NUMBER	MARK	R <sub>1</sub>	R <sub>2</sub>	UNIT
KN4A4M	A7	10.0	10.0	kΩ
KN4F4M	B7	22.0	22.0	kΩ
KN4L4M	C7	47.0	47.0	kΩ
KN4L3M	D7	4.7	4.7	kΩ
KN4L3N	E7	4.7	10.0	kΩ
KN4L3Z	F7	4.7		kΩ
KN4A3Q	G7	1.0	10.0	kΩ
KN4A4P	H7	10.0	47.0	kΩ
KN4F4N	X7	22.0	47.0	kΩ

PART NUMBER	MARK	R <sub>1</sub>	R <sub>2</sub>	UNIT
KN4L4L	K7	47.0	22.0	kΩ
KN4A4Z	Y7	10.0		kΩ
KN4F4Z	Z7	22.0		kΩ
KN4L4Z	N7	47.0		kΩ
KN4F3M	P7	2.2	2.2	kΩ
KN4F3P	Q7	2.2	10.0	kΩ
KN4F3R	R7	2.2	47.0	kΩ
KN4A4L	S7	10.0	4.7	kΩ
KN4L4K	T7	47.0	10.0	kΩ

The information in this document is subject to change without notice. Before using this document, please confirm that this is the latest version.

Not all products and/or types are available in every country. Please check with an NEC Electronics sales representative for availability and additional information.

**ELECTRICAL CHARACTERISTICS (T<sub>A</sub> = 25°C)**

CHARACTERISTICS	SYMBOL	TEST CONDITIONS	MIN.	TYP.	MAX.	UNIT
Collector Cut-off Current	I <sub>CBO</sub>	V <sub>CB</sub> = -5.0 V, I <sub>E</sub> = 0			-100	nA
DC Current Gain	h <sub>FE1</sub>	V <sub>CE</sub> = -5.0 V, I <sub>C</sub> = -5.0 mA	<b>Note1</b>			-
	h <sub>FE2</sub>	V <sub>CE</sub> = -5.0 V, I <sub>C</sub> = -50 mA				-
Collector Saturation Voltage	V <sub>CE(sat)</sub>	I <sub>C</sub> = -5.0 mA, I <sub>B</sub> = -0.25 mA			-0.2	V
Low-level Input Voltage	V <sub>IL</sub>	V <sub>CE</sub> = -5.0 V, I <sub>C</sub> = -100 μA	<b>Note2</b>			V
High-level Input Voltage	V <sub>IH</sub>	V <sub>CE</sub> = -0.2 V, I <sub>C</sub> = -5.0 mA				V
Input Resistor	R <sub>1</sub>		<b>Note3</b>			kΩ
Emitter to Base Resistor	R <sub>2</sub>					kΩ

**Note 1.**

PART NUMBER	h <sub>FE1</sub>			h <sub>FE2</sub>			UNIT
	MIN.	TYP.	MAX.	MIN.	TYP.	MAX.	
KN4A4M	35		100	80			-
KN4F4M	60		195	90			-
KN4L4M	85		340	95			-
KN4L3M	20		80	80			-
KN4L3N	35		100	80			-
KN4L3Z	135		600	100			-
KN4A3Q	35		100	80			-
KN4A4P	85		340	95			-
KN4F4N	85		340	95			-
KN4L4L	60		195	90			-
KN4A4Z	135		600	100			-
KN4F4Z	135		600	100			-
KN4L4Z	135		600	100			-
KN4F3M	8		50	50			-
KN4F3P	35		100	80			-
KN4F3R	85		340	95			-
KN4A4L	20		80	80			-
KN4L4K	35		100	80			-

**Note 2.**

PART NUMBER	V <sub>IL</sub>			V <sub>IH</sub>			UNIT
	MIN.	TYP.	MAX.	MIN.	TYP.	MAX.	
KN4A4M			-0.8	-3.0			V
KN4F4M			-0.8	-4.0			V
KN4L4M			-0.8	-5.0			V
KN4L3M			-0.8	-3.0			V
KN4L3N			-0.6	-3.0			V
KN4L3Z			-0.5	-1.2			V
KN4A3Q			-0.5	-2.0			V
KN4A4P			-0.5	-3.0			V
KN4F4N			-0.6	-3.0			V
KN4L4L			-0.9	-6.0			V
KN4A4Z			-0.5	-2.0			V
KN4F4Z			-0.5	-3.0			V
KN4L4Z			-0.5	-4.0			V
KN4F3M			-0.8	-3.0			V
KN4F3P			-0.5	-2.0			V
KN4F3R			-0.5	-2.0			V
KN4A4L			-0.9	-6.0			V
KN4L4K			-2.0	-8.0			V

**Note 3.**

PART NUMBER	R <sub>1</sub>			R <sub>2</sub>			UNIT
	MIN.	TYP.	MAX.	MIN.	TYP.	MAX.	
KN4A4M	7.00	10.00	13.00	7.00	10.00	13.00	kΩ
KN4F4M	15.40	22.00	28.60	15.40	22.00	28.60	kΩ
KN4L4M	32.90	47.00	61.10	32.90	47.00	61.10	kΩ
KN4L3M	3.29	4.70	6.11	3.29	4.70	6.11	kΩ
KN4L3N	3.29	4.70	6.11	7.00	10.00	13.00	kΩ
KN4L3Z	3.29	4.70	6.11				kΩ
KN4A3Q	0.70	1.00	1.30	7.00	10.00	13.00	kΩ
KN4A4P	7.00	10.00	13.00	32.90	47.00	61.10	kΩ
KN4F4N	15.40	22.00	28.60	32.90	47.00	61.10	kΩ
KN4L4L	32.90	47.00	61.10	15.40	22.00	28.60	kΩ
KN4A4Z	7.00	10.00	13.00				kΩ
KN4F4Z	15.40	22.00	28.60				kΩ
KN4L4Z	32.90	47.00	61.10				kΩ
KN4F3M	1.54	2.20	2.86	1.54	2.20	2.86	kΩ
KN4F3P	1.54	2.20	2.86	7.00	10.00	13.00	kΩ
KN4F3R	1.54	2.20	2.86	32.90	47.00	61.10	kΩ
KN4A4L	7.00	10.00	13.00	3.29	4.70	6.11	kΩ
KN4L4K	32.90	47.00	61.10	7.00	10.00	13.00	kΩ

TOTAL POWER DISSIPATION vs. AMBIENT TEMPERATURE

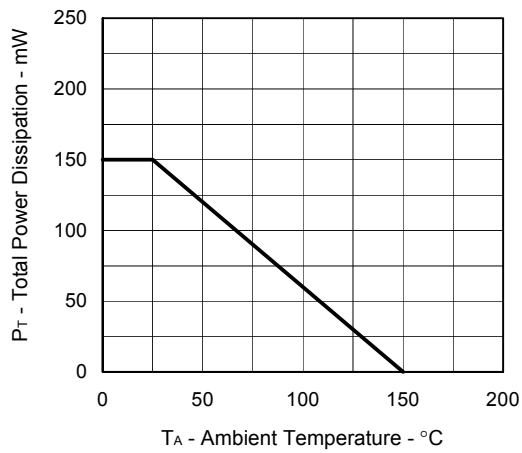

**[KN4A4M]**  
**TYPICAL CHARACTERISTICS (T<sub>A</sub> = 25°C)**

COLLECTOR CURRENT vs. COLLECTOR TO EMITTER VOLTAGE

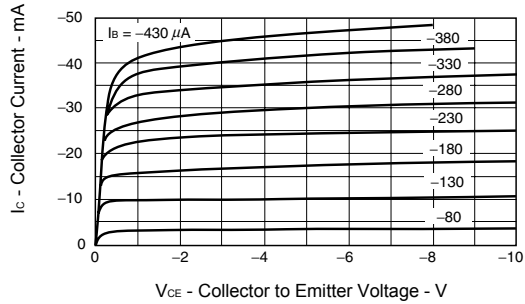

COLLECTOR TO EMITTER VOLTAGE vs. COLLECTOR CURRENT

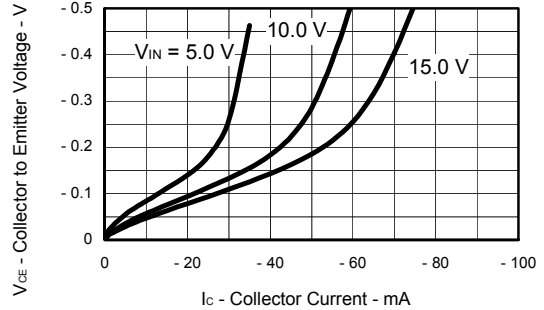

DC CURRENT GAIN vs. COLLECTOR CURRENT

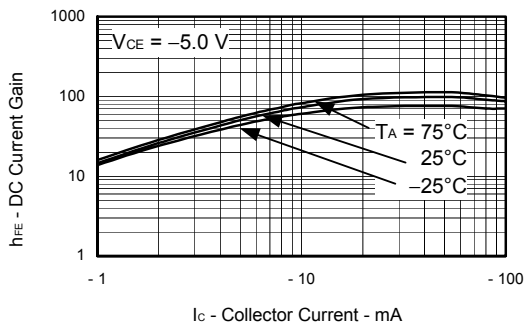

COLLECTOR SATURATION VOLTAGE vs. COLLECTOR CURRENT

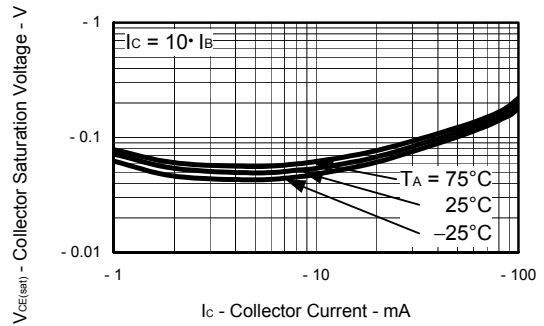

INPUT VOLTAGE vs. COLLECTOR CURRENT

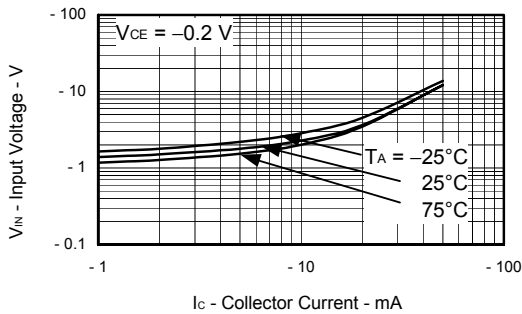

COLLECTOR CURRENT vs. INPUT VOLTAGE

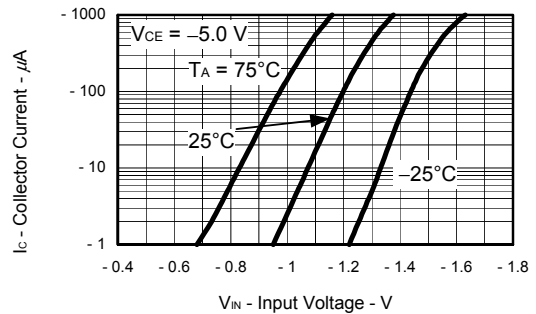

RESISTOR vs. AMBIENT TEMPERATURE

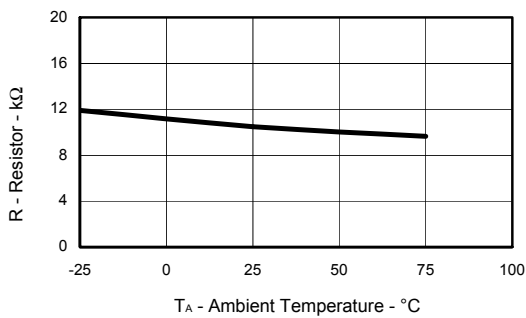

**[KN4F4M]**  
**TYPICAL CHARACTERISTICS (T<sub>A</sub> = 25°C)**

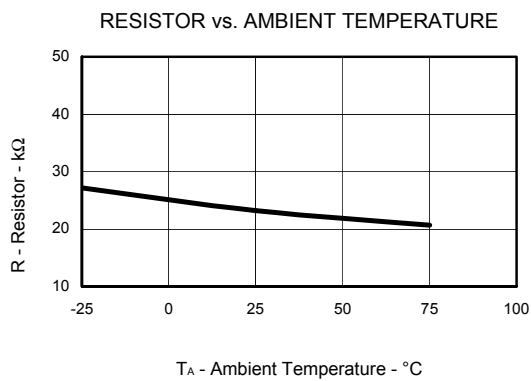
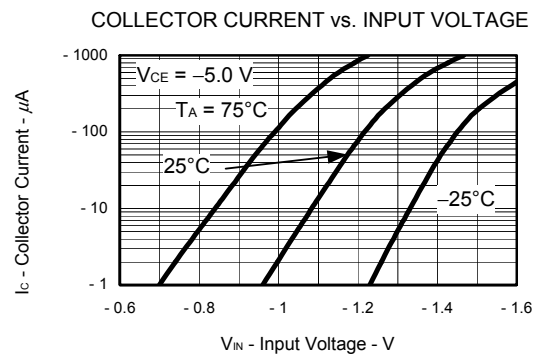
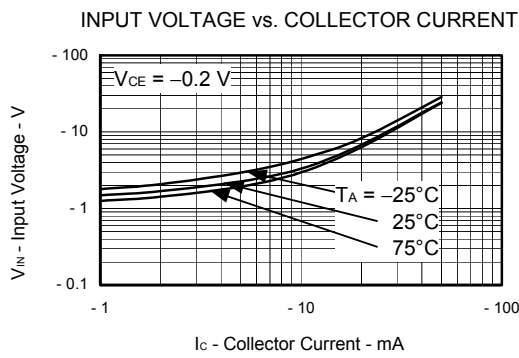
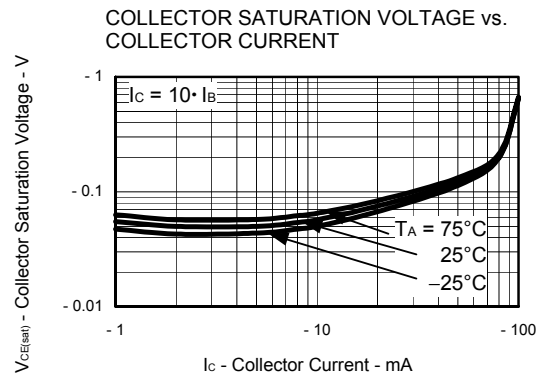
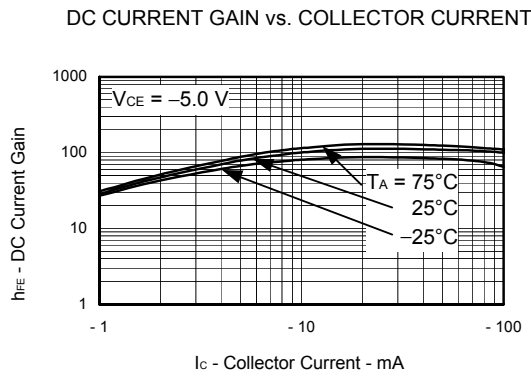
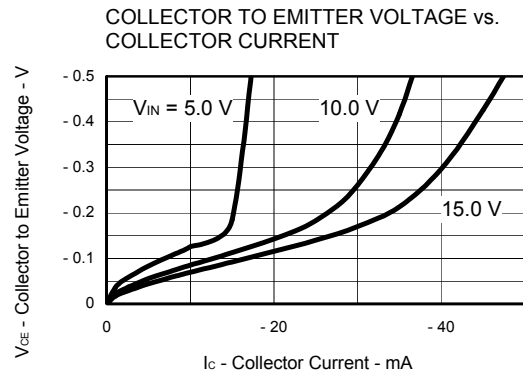
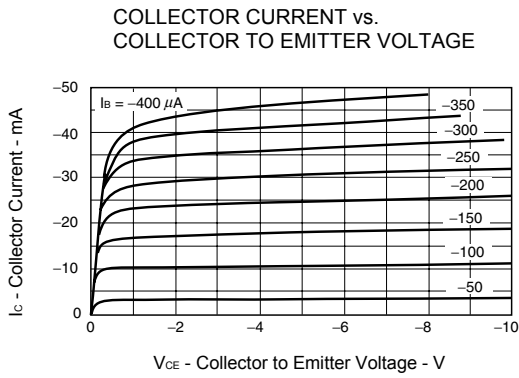

**[KN4L4M]**  
**TYPICAL CHARACTERISTICS (T<sub>A</sub> = 25°C)**

COLLECTOR CURRENT vs. COLLECTOR TO EMITTER VOLTAGE

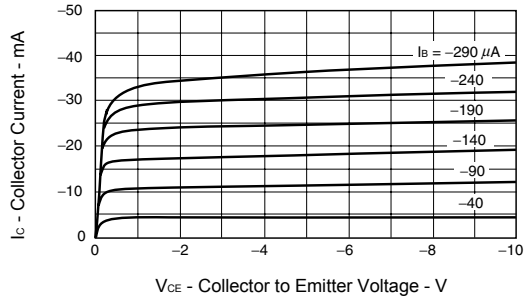

COLLECTOR TO EMITTER VOLTAGE vs. COLLECTOR CURRENT

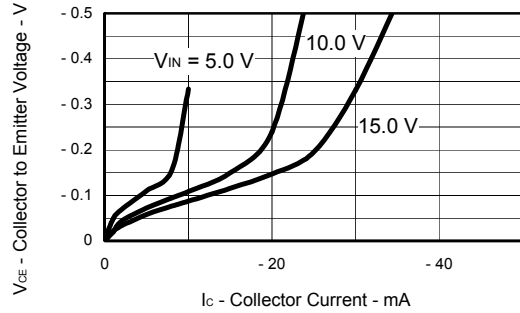

DC CURRENT GAIN vs. COLLECTOR CURRENT

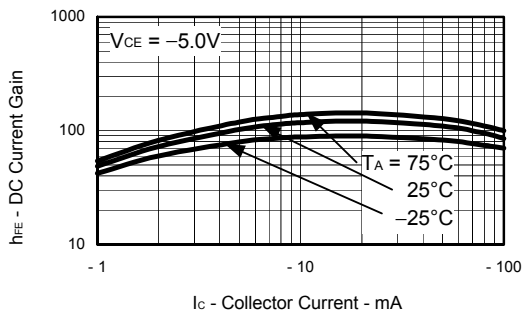

COLLECTOR SATURATION VOLTAGE vs. COLLECTOR CURRENT

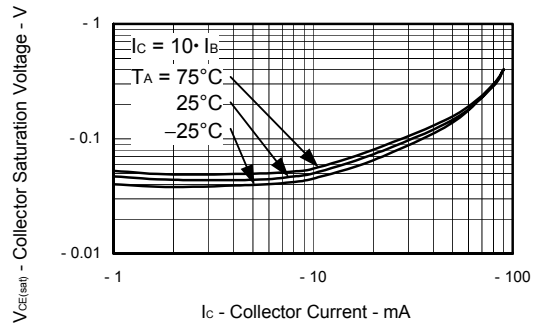

INPUT VOLTAGE vs. COLLECTOR CURRENT

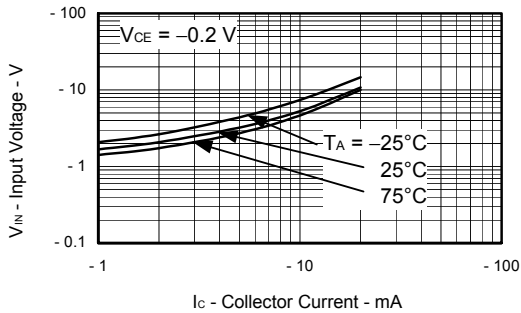

COLLECTOR CURRENT vs. INPUT VOLTAGE

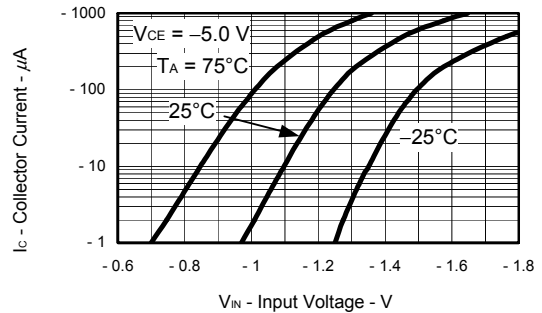

RESISTOR vs. AMBIENT TEMPERATURE

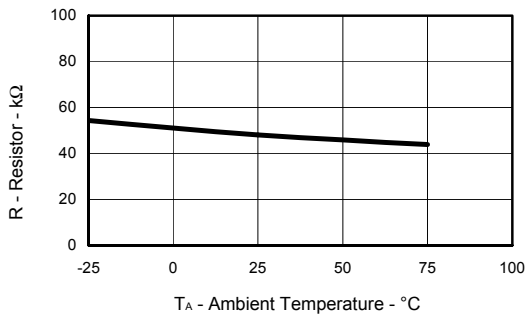

**[KN4L3M]**  
**TYPICAL CHARACTERISTICS (T<sub>A</sub> = 25°C)**

COLLECTOR CURRENT vs. COLLECTOR TO EMITTER VOLTAGE

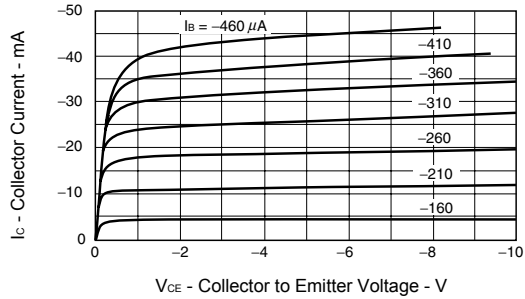

COLLECTOR TO EMITTER VOLTAGE vs. COLLECTOR CURRENT

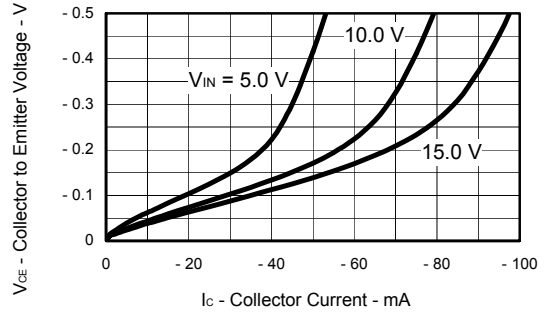

DC CURRENT GAIN vs. COLLECTOR CURRENT

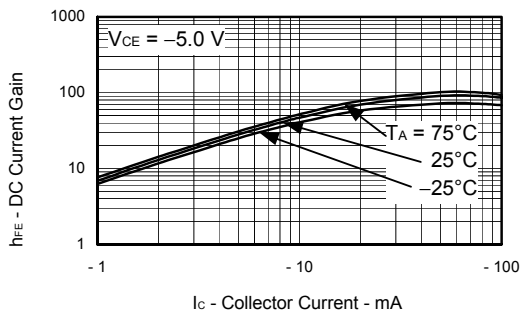

COLLECTOR SATURATION VOLTAGE vs. COLLECTOR CURRENT

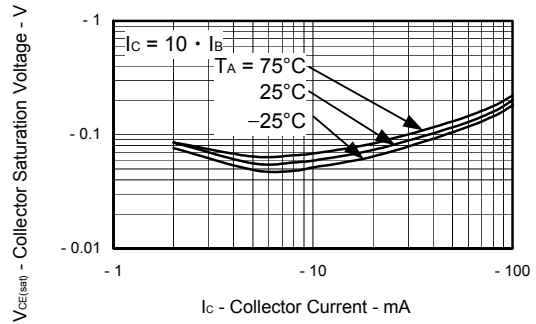

INPUT VOLTAGE vs. COLLECTOR CURRENT

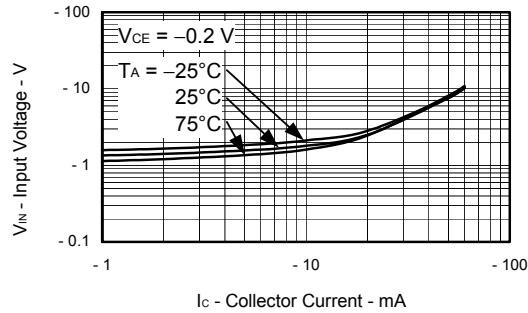

COLLECTOR CURRENT vs. INPUT VOLTAGE

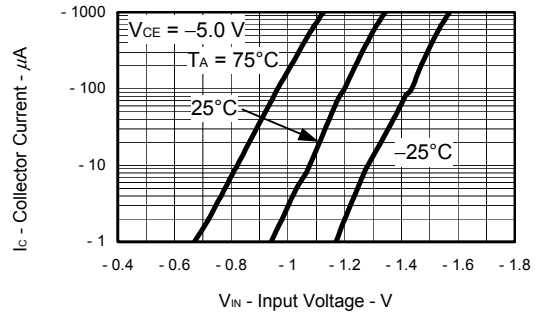

RESISTOR vs. AMBIENT TEMPERATURE

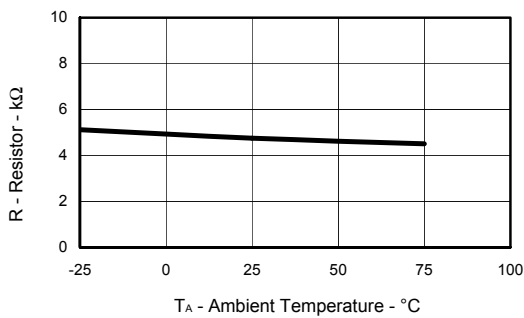

**[KN4L3N]**  
**TYPICAL CHARACTERISTICS (T<sub>A</sub> = 25°C)**

COLLECTOR CURRENT vs. COLLECTOR TO EMITTER VOLTAGE

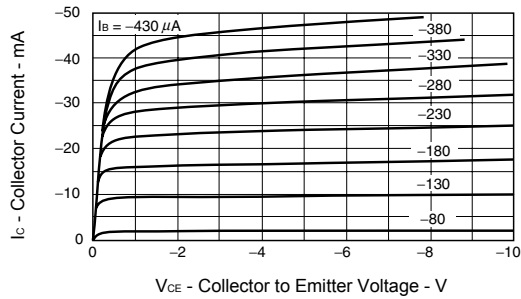

COLLECTOR TO EMITTER VOLTAGE vs. COLLECTOR CURRENT

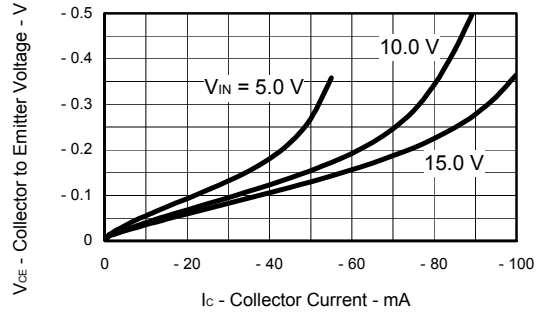

DC CURRENT GAIN vs. COLLECTOR CURRENT

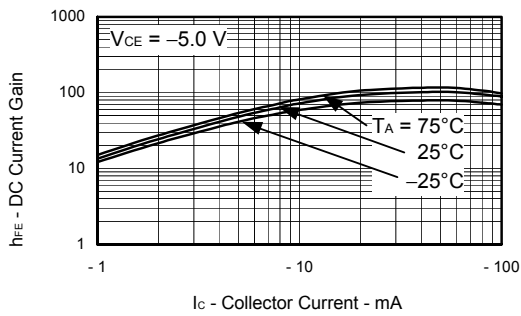

COLLECTOR SATURATION VOLTAGE vs. COLLECTOR CURRENT

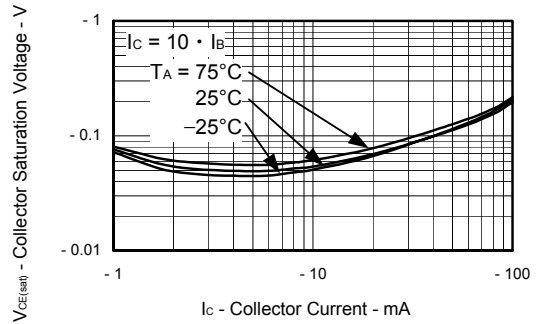

INPUT VOLTAGE vs. COLLECTOR CURRENT

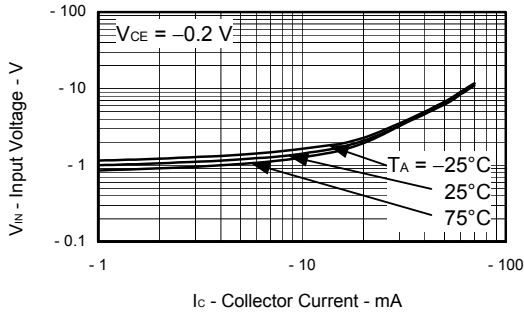

COLLECTOR CURRENT vs. INPUT VOLTAGE

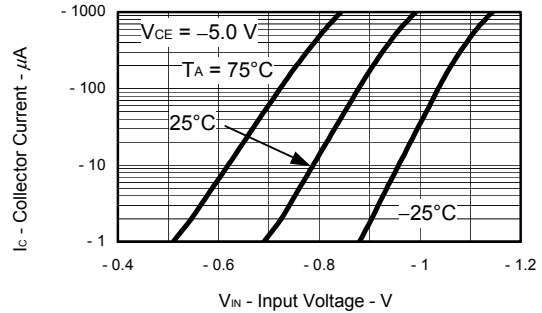

RESISTOR vs. AMBIENT TEMPERATURE

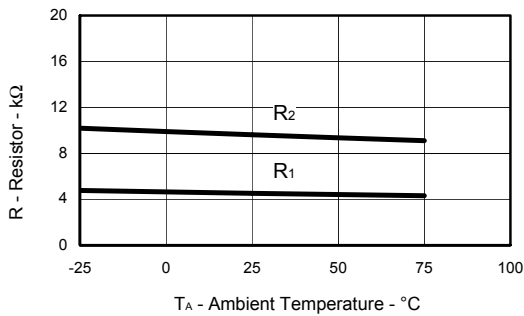



**[KN4L3Z]**  
**TYPICAL CHARACTERISTICS (T<sub>A</sub> = 25°C)**

COLLECTOR CURRENT vs. COLLECTOR TO EMITTER VOLTAGE

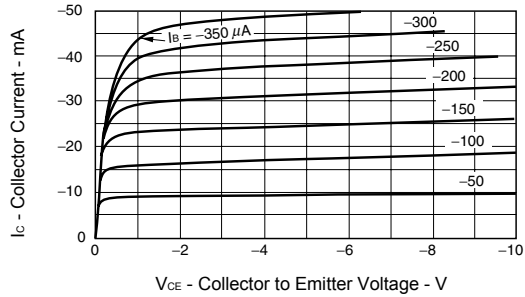

COLLECTOR TO EMITTER VOLTAGE vs. COLLECTOR CURRENT

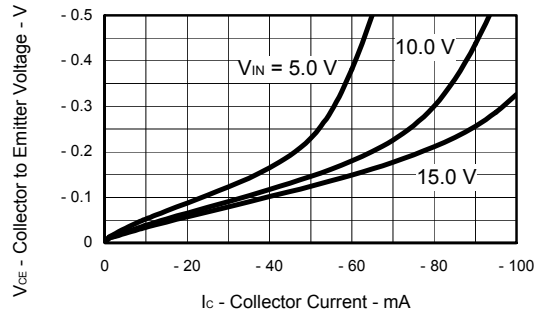

DC CURRENT GAIN vs. COLLECTOR CURRENT

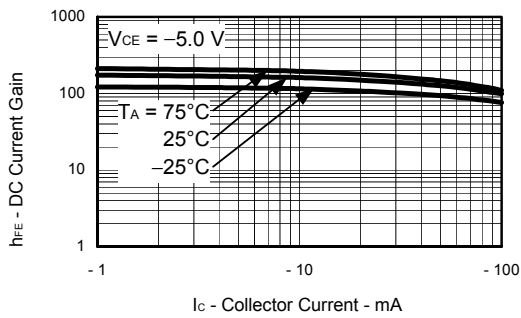

COLLECTOR SATURATION VOLTAGE vs. COLLECTOR CURRENT

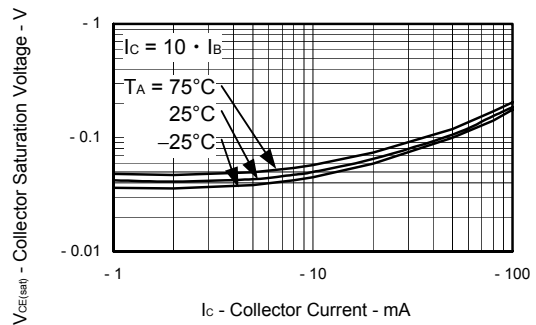

INPUT VOLTAGE vs. COLLECTOR CURRENT

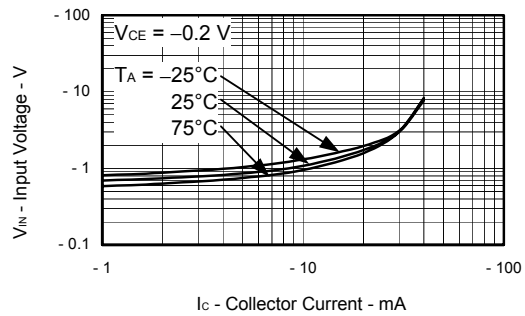

COLLECTOR CURRENT vs. INPUT VOLTAGE

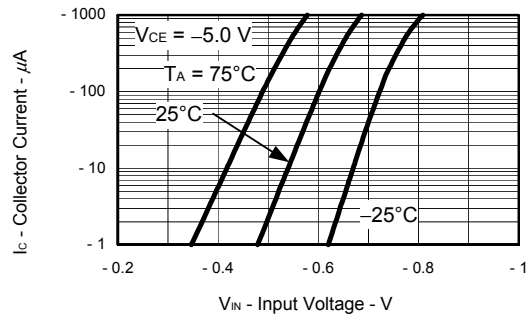

RESISTOR vs. AMBIENT TEMPERATURE

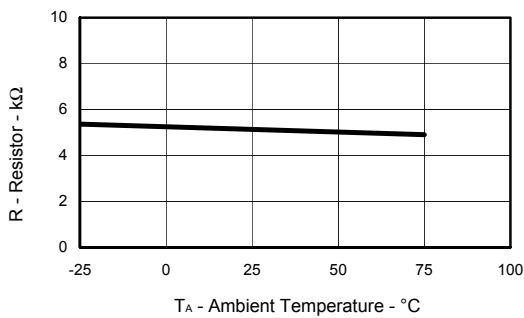

[KN4A3Q]  
TYPICAL CHARACTERISTICS (T<sub>A</sub> = 25°C)

COLLECTOR CURRENT vs. COLLECTOR TO EMITTER VOLTAGE

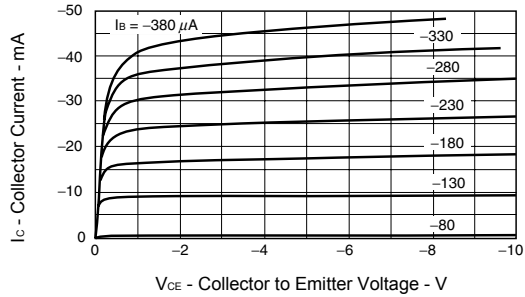

COLLECTOR TO EMITTER VOLTAGE vs. COLLECTOR CURRENT

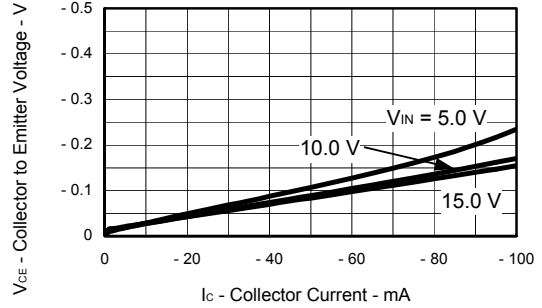

DC CURRENT GAIN vs. COLLECTOR CURRENT

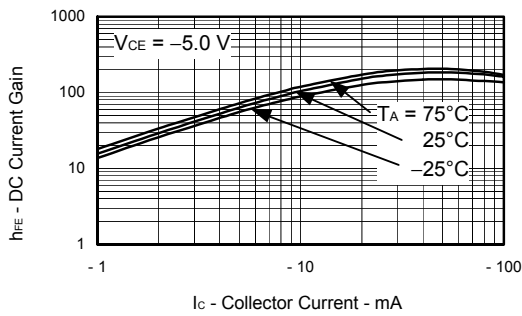

COLLECTOR SATURATION VOLTAGE vs. COLLECTOR CURRENT

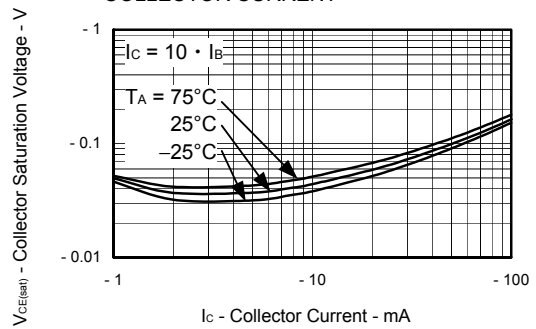

INPUT VOLTAGE vs. COLLECTOR CURRENT

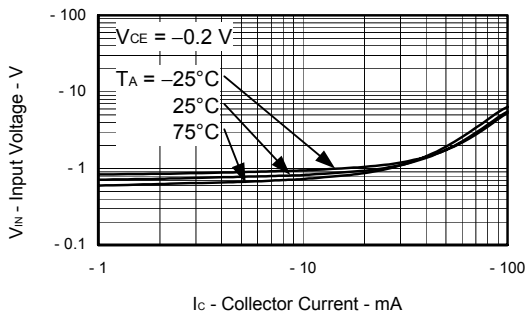

COLLECTOR CURRENT vs. INPUT VOLTAGE

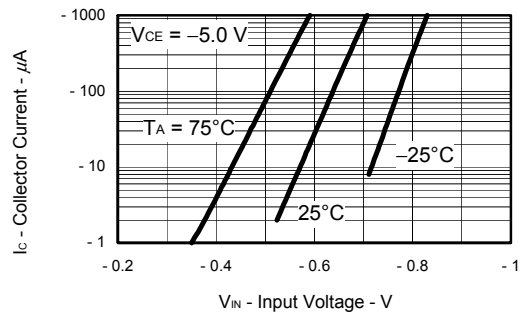

RESISTOR vs. AMBIENT TEMPERATURE

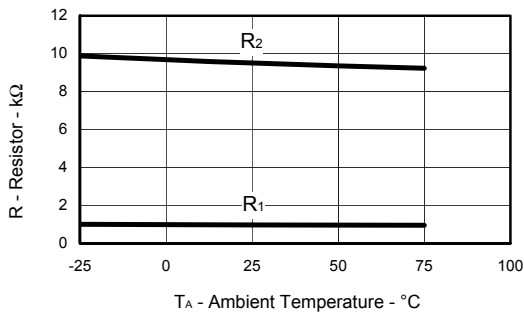

[KN4A4P]  
TYPICAL CHARACTERISTICS (T<sub>A</sub> = 25°C)

COLLECTOR CURRENT vs. COLLECTOR TO EMITTER VOLTAGE

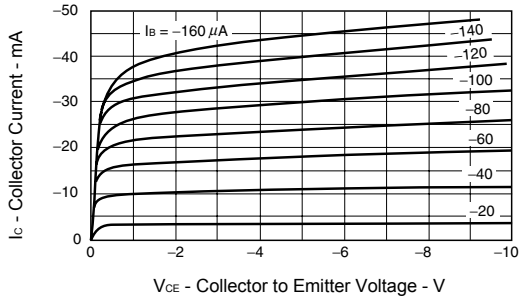

COLLECTOR TO EMITTER VOLTAGE vs. COLLECTOR CURRENT

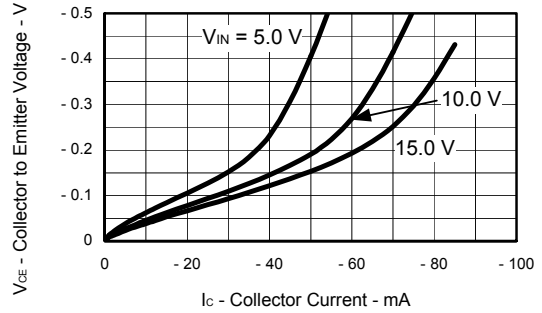

DC CURRENT GAIN vs. COLLECTOR CURRENT

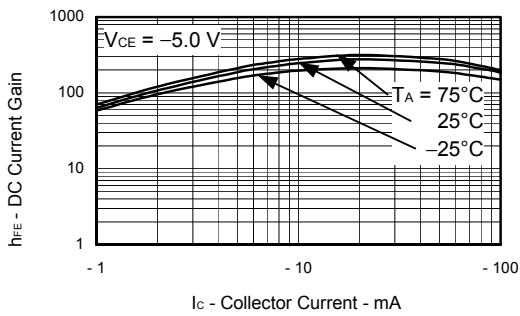

COLLECTOR SATURATION VOLTAGE vs. COLLECTOR CURRENT

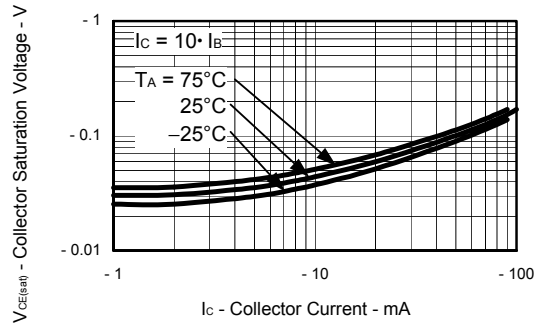

INPUT VOLTAGE vs. COLLECTOR CURRENT

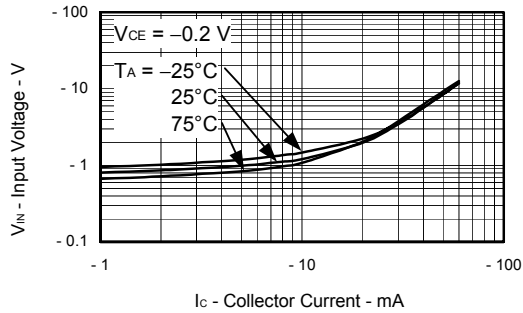

COLLECTOR CURRENT vs. INPUT VOLTAGE

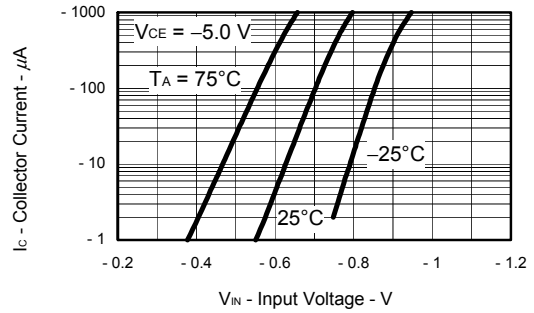

RESISTOR vs. AMBIENT TEMPERATURE

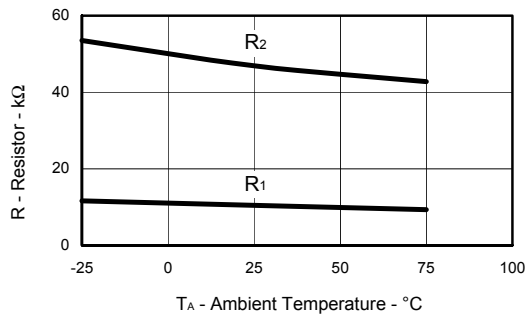

[KN4F4N]

TYPICAL CHARACTERISTICS (T<sub>A</sub> = 25°C)

COLLECTOR CURRENT vs. COLLECTOR TO EMITTER VOLTAGE

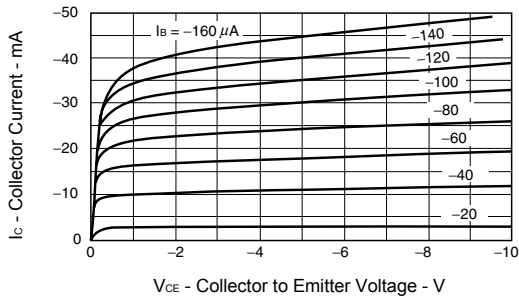

COLLECTOR TO EMITTER VOLTAGE vs. COLLECTOR CURRENT

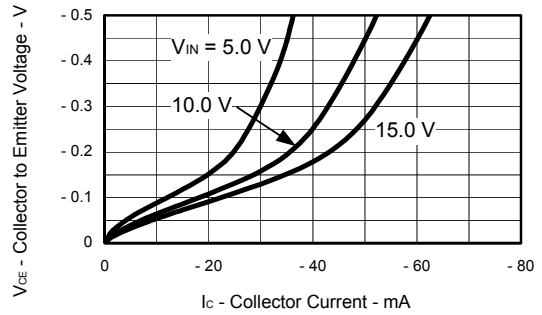

DC CURRENT GAIN vs. COLLECTOR CURRENT

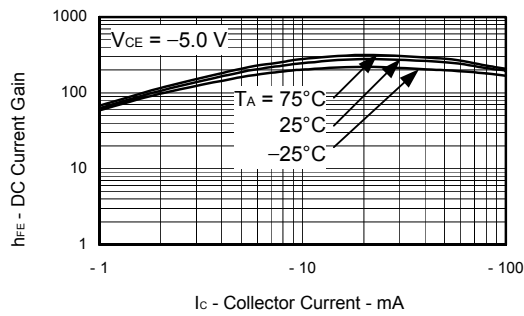

COLLECTOR SATURATION VOLTAGE vs. COLLECTOR CURRENT

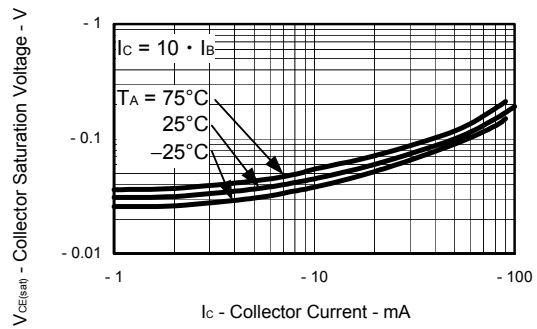

INPUT VOLTAGE vs. COLLECTOR CURRENT

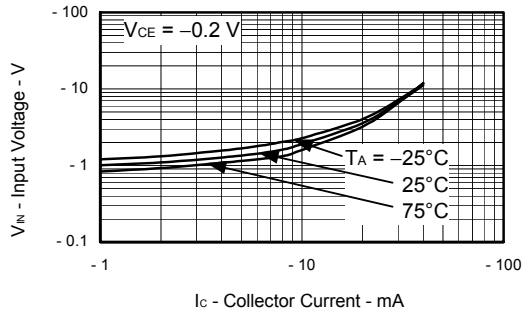

COLLECTOR CURRENT vs. INPUT VOLTAGE

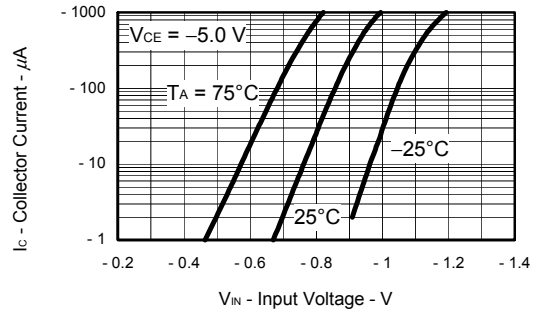

RESISTOR vs. AMBIENT TEMPERATURE

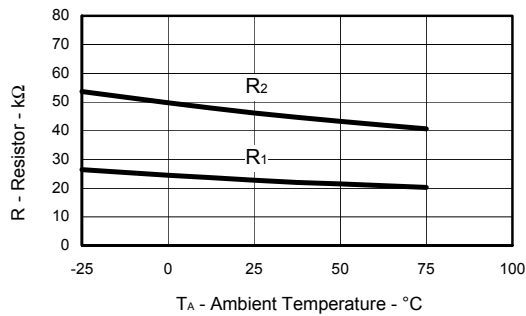

[KN4L4L]  
TYPICAL CHARACTERISTICS (T<sub>A</sub> = 25°C)

COLLECTOR CURRENT vs. COLLECTOR TO EMITTER VOLTAGE

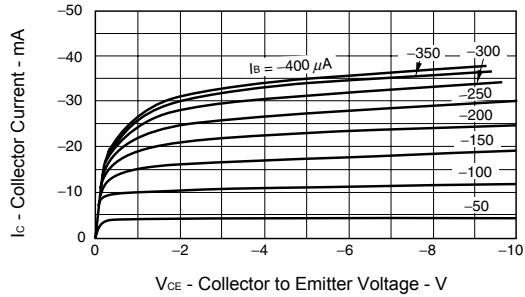

COLLECTOR TO EMITTER VOLTAGE vs. COLLECTOR CURRENT

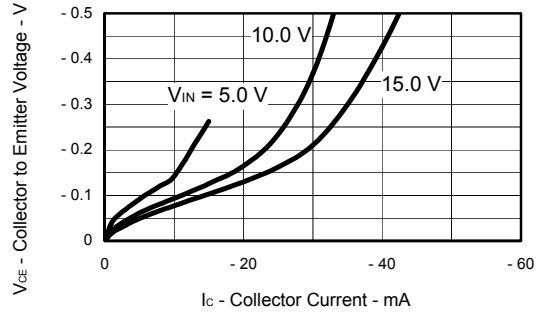

DC CURRENT GAIN vs. COLLECTOR CURRENT

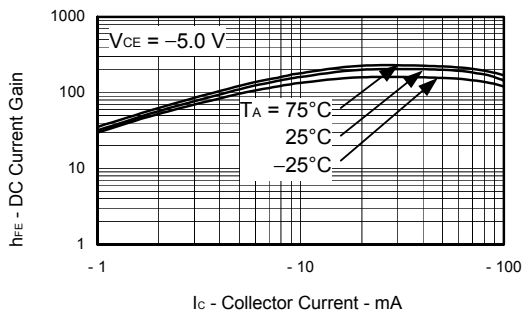

COLLECTOR SATURATION VOLTAGE vs. COLLECTOR CURRENT

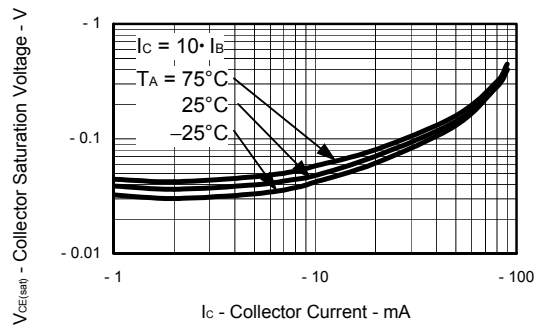

INPUT VOLTAGE vs. COLLECTOR CURRENT

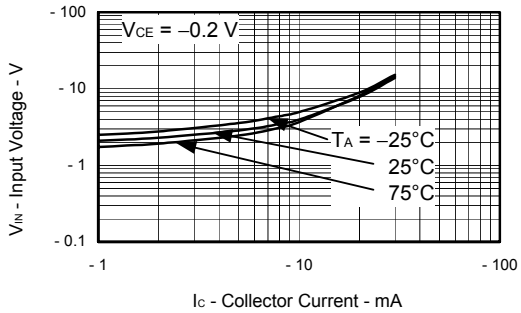

COLLECTOR CURRENT vs. INPUT VOLTAGE

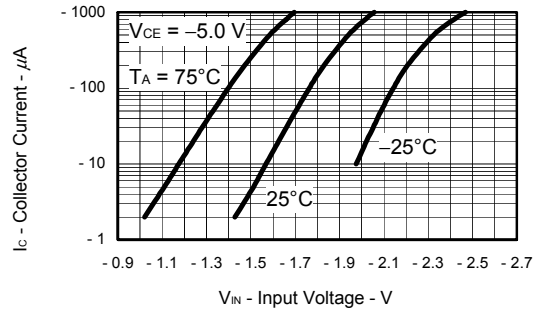

RESISTOR vs. AMBIENT TEMPERATURE

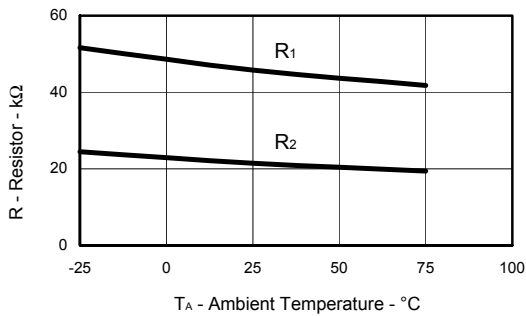

**[KN4A4Z]**  
**TYPICAL CHARACTERISTICS (T<sub>A</sub> = 25°C)**

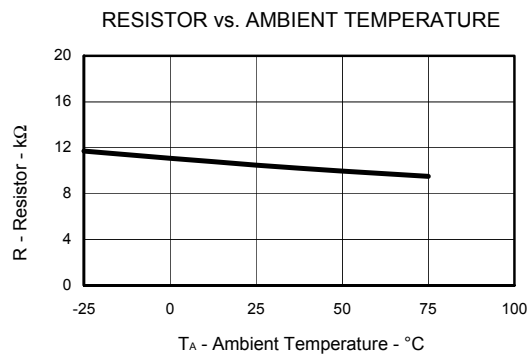
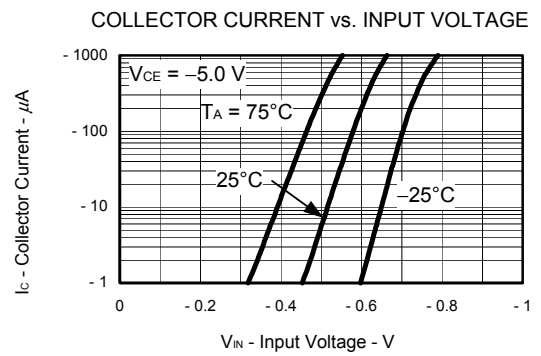
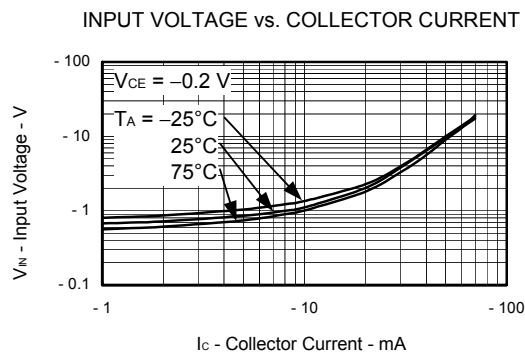
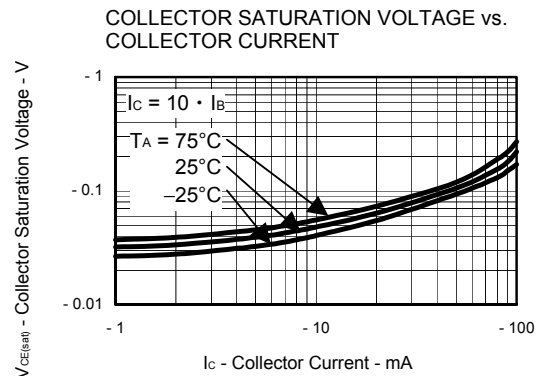
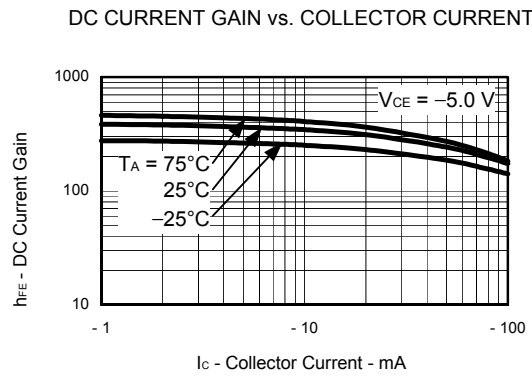
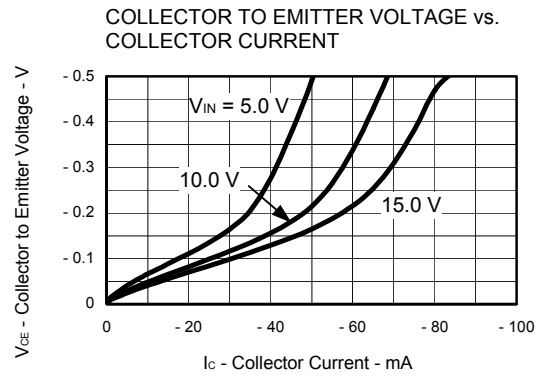
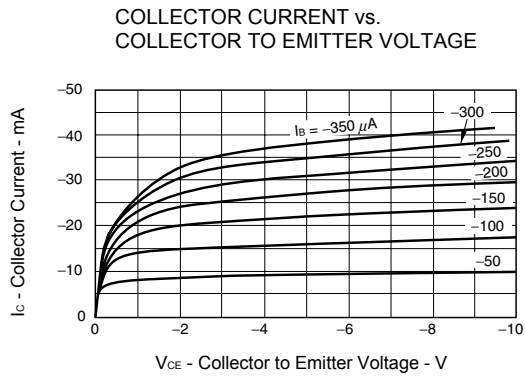

**[KN4F4Z]**  
**TYPICAL CHARACTERISTICS (T<sub>A</sub> = 25°C)**

COLLECTOR CURRENT vs. COLLECTOR TO EMITTER VOLTAGE

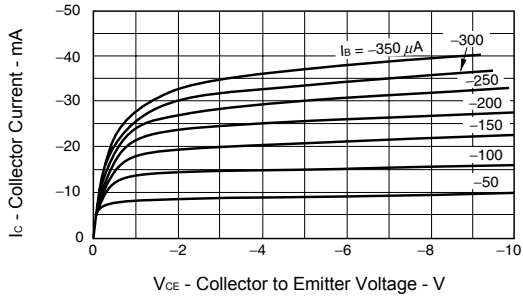

COLLECTOR TO EMITTER VOLTAGE vs. COLLECTOR CURRENT

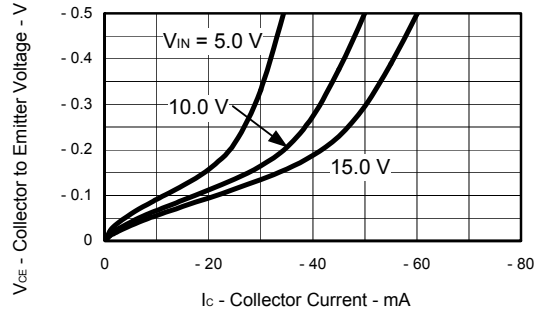

DC CURRENT GAIN vs. COLLECTOR CURRENT

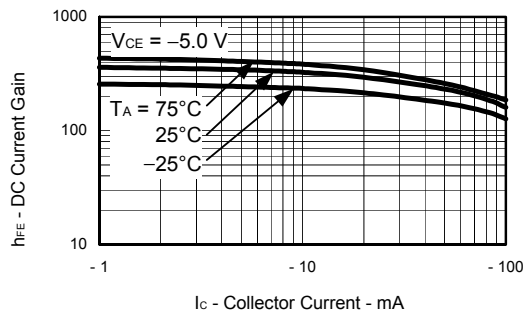

COLLECTOR SATURATION VOLTAGE vs. COLLECTOR CURRENT

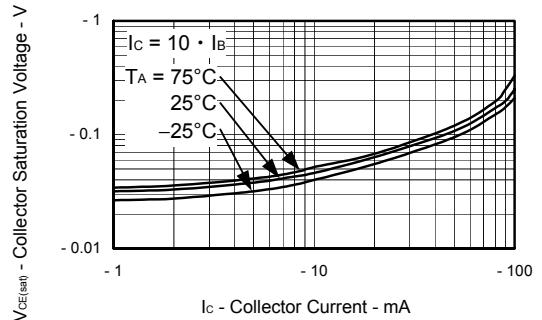

INPUT VOLTAGE vs. COLLECTOR CURRENT

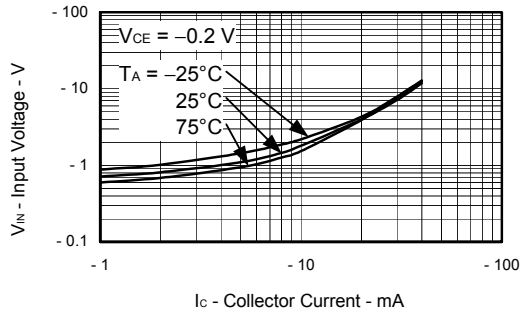

COLLECTOR CURRENT vs. INPUT VOLTAGE

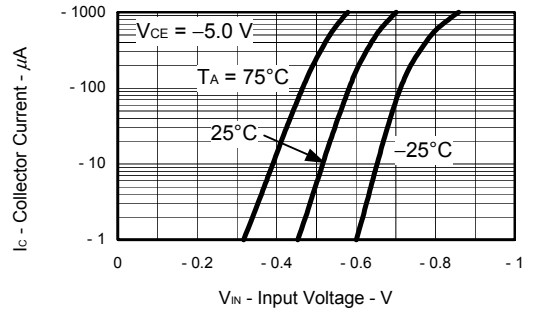

RESISTOR vs. AMBIENT TEMPERATURE

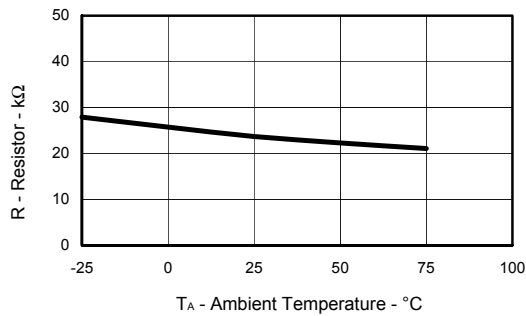

**[KN4L4Z]**  
**TYPICAL CHARACTERISTICS (T<sub>A</sub> = 25°C)**

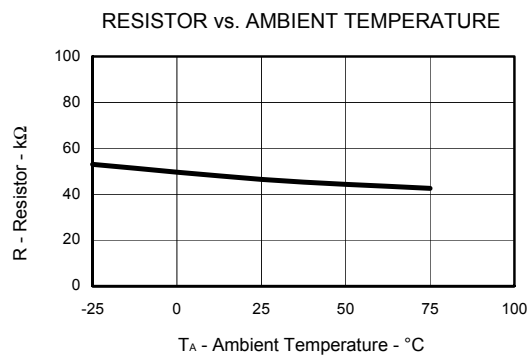
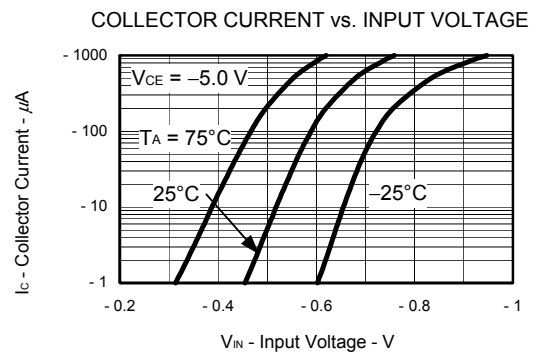
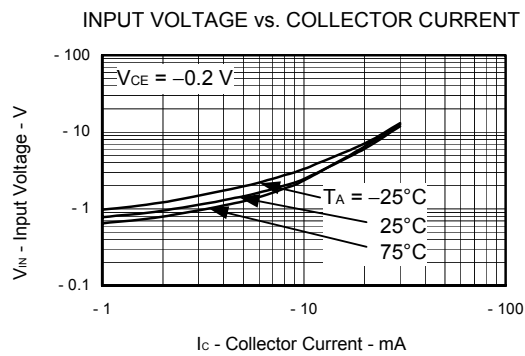
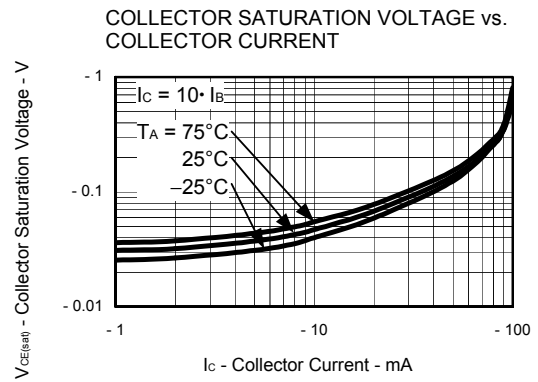
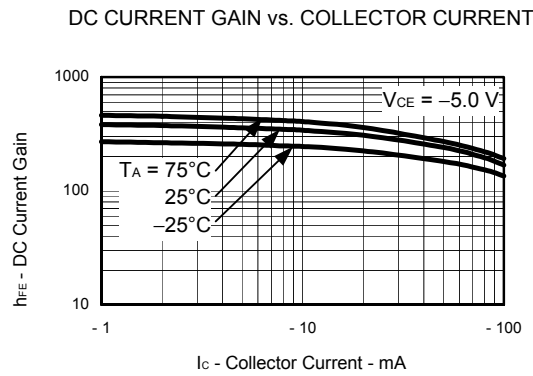
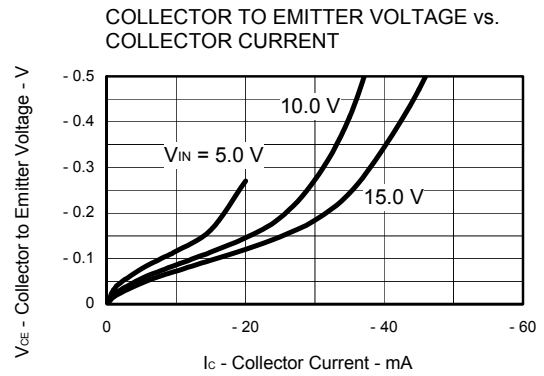
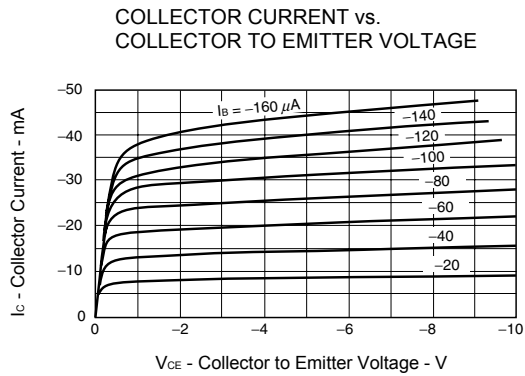



[KN4F3M]  
 TYPICAL CHARACTERISTICS (T<sub>A</sub> = 25°C)

COLLECTOR CURRENT vs. COLLECTOR TO EMITTER VOLTAGE

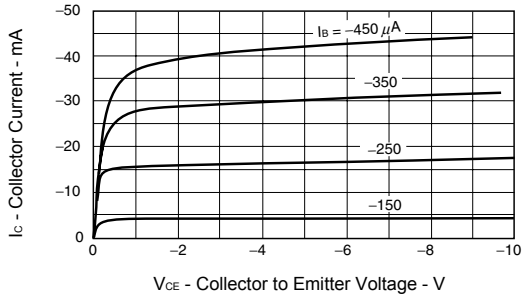

COLLECTOR TO EMITTER VOLTAGE vs. COLLECTOR CURRENT

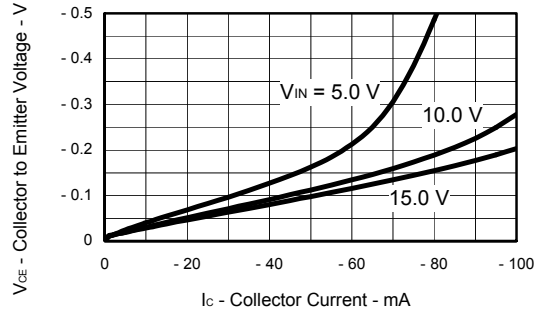

DC CURRENT GAIN vs. COLLECTOR CURRENT

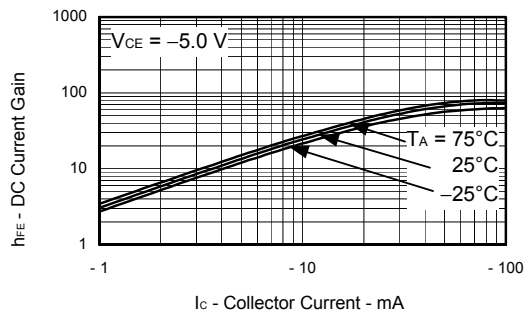

COLLECTOR SATURATION VOLTAGE vs. COLLECTOR CURRENT

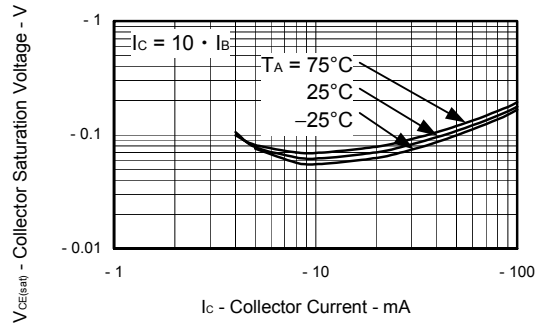

INPUT VOLTAGE vs. COLLECTOR CURRENT

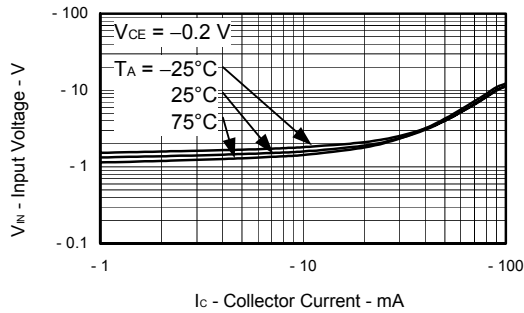

COLLECTOR CURRENT vs. INPUT VOLTAGE

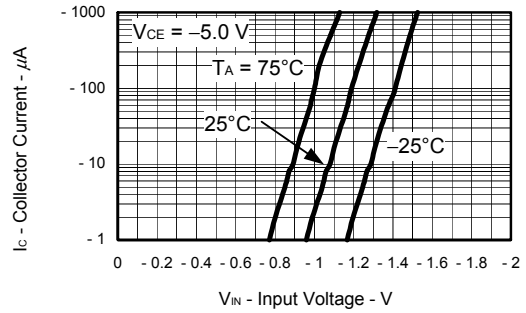

RESISTOR vs. AMBIENT TEMPERATURE

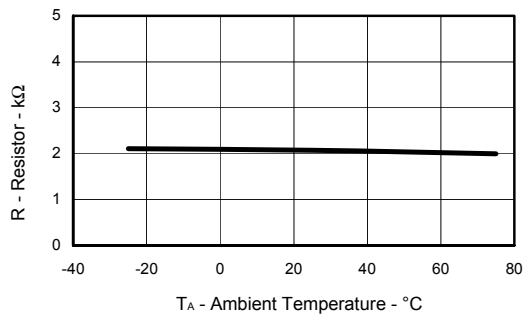

**[KN4F3P]**  
**TYPICAL CHARACTERISTICS (T<sub>A</sub> = 25°C)**

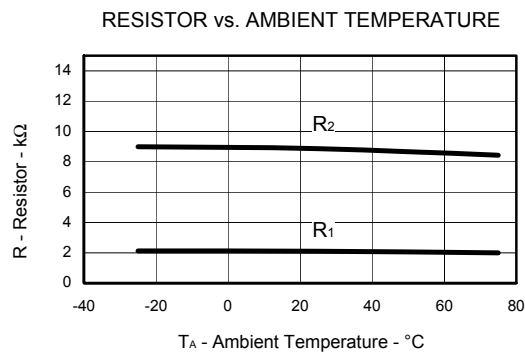
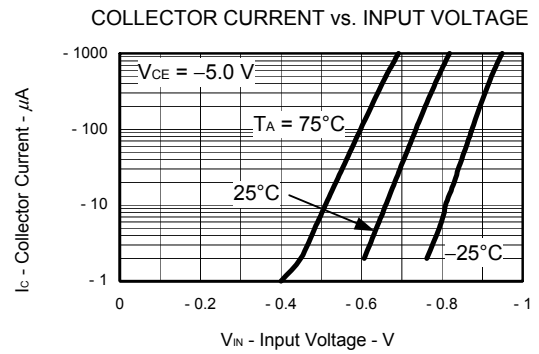
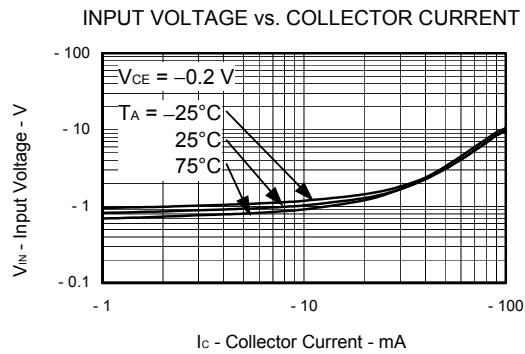
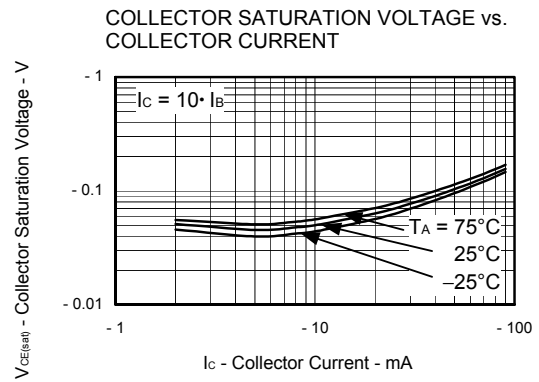
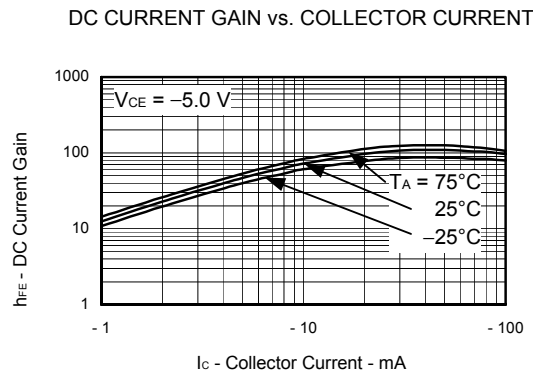
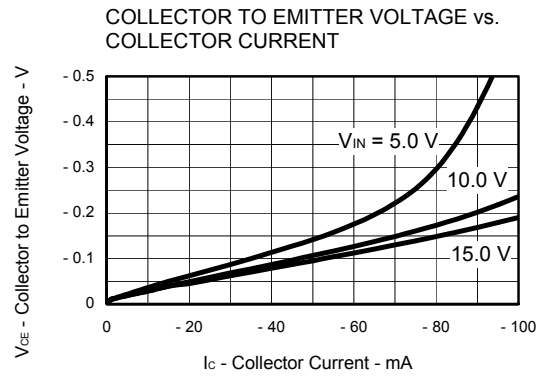
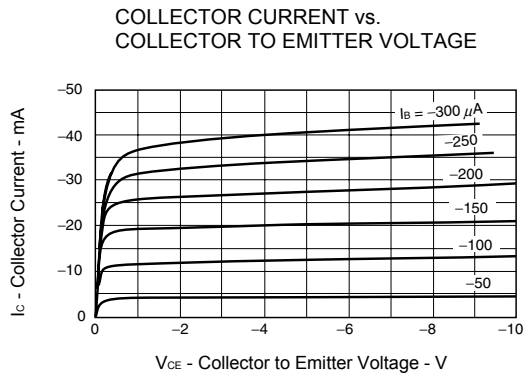

[KN4F3R]  
TYPICAL CHARACTERISTICS (T<sub>A</sub> = 25°C)

COLLECTOR CURRENT vs. COLLECTOR TO EMITTER VOLTAGE

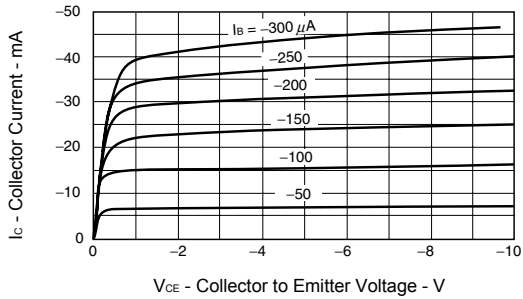

COLLECTOR TO EMITTER VOLTAGE vs. COLLECTOR CURRENT

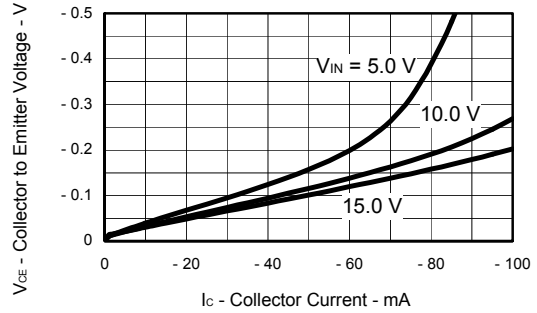

DC CURRENT GAIN vs. COLLECTOR CURRENT

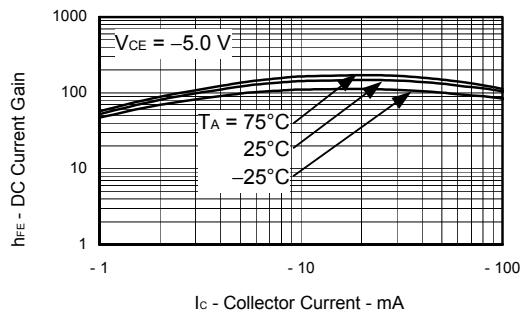

COLLECTOR SATURATION VOLTAGE vs. COLLECTOR CURRENT

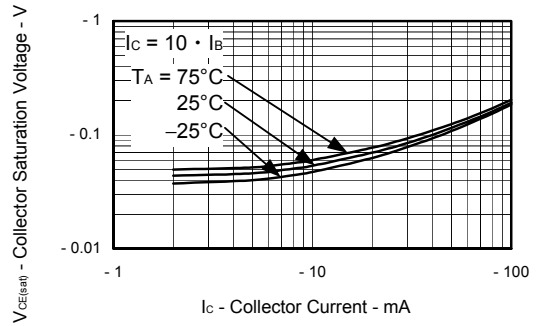

INPUT VOLTAGE vs. COLLECTOR CURRENT

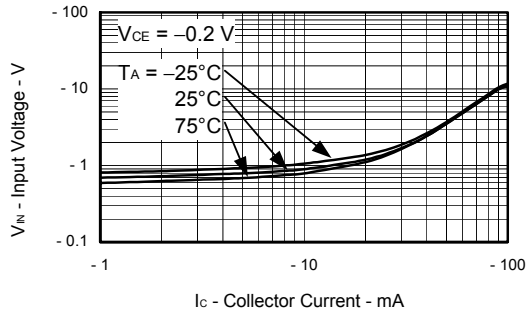

COLLECTOR CURRENT vs. INPUT VOLTAGE

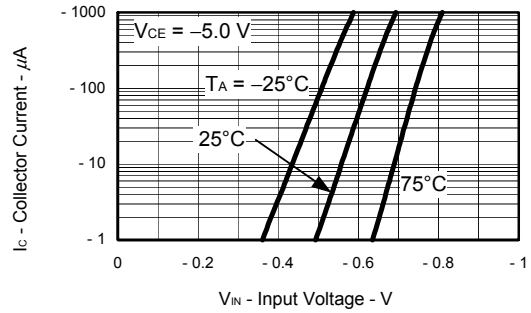

RESISTOR vs. AMBIENT TEMPERATURE

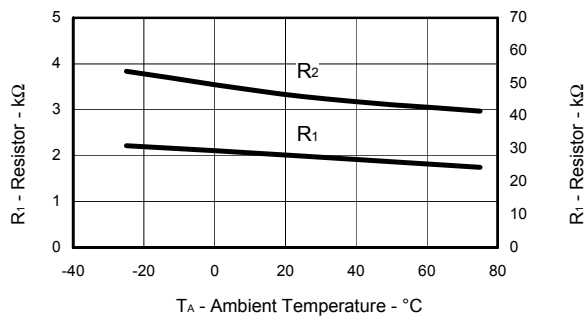

[KN4A4L]  
TYPICAL CHARACTERISTICS (T<sub>A</sub> = 25°C)

COLLECTOR CURRENT vs. COLLECTOR TO EMITTER VOLTAGE

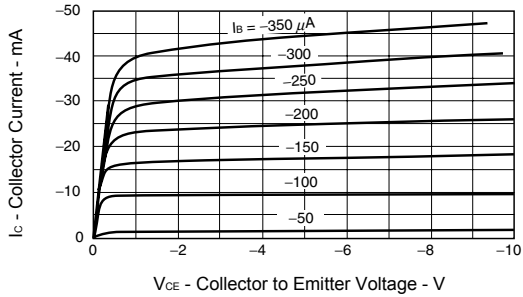

COLLECTOR TO EMITTER VOLTAGE vs. COLLECTOR CURRENT

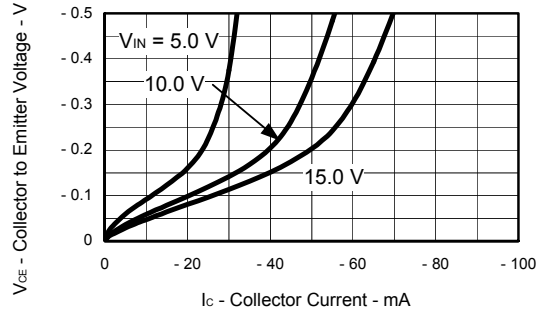

DC CURRENT GAIN vs. COLLECTOR CURRENT

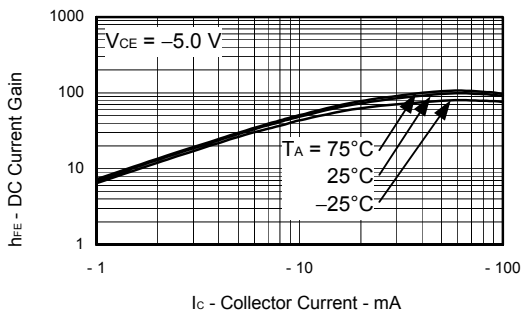

COLLECTOR SATURATION VOLTAGE vs. COLLECTOR CURRENT

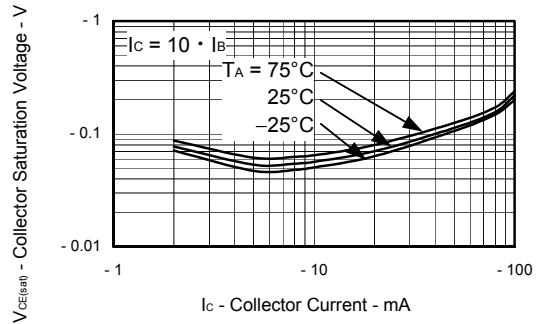

INPUT VOLTAGE vs. COLLECTOR CURRENT

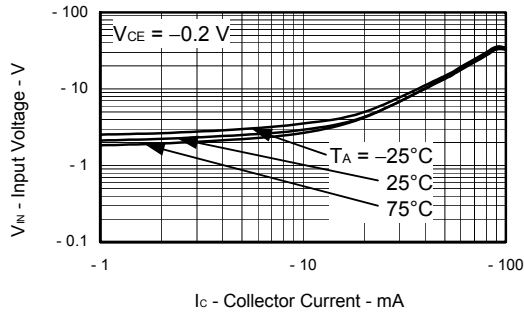

COLLECTOR CURRENT vs. INPUT VOLTAGE

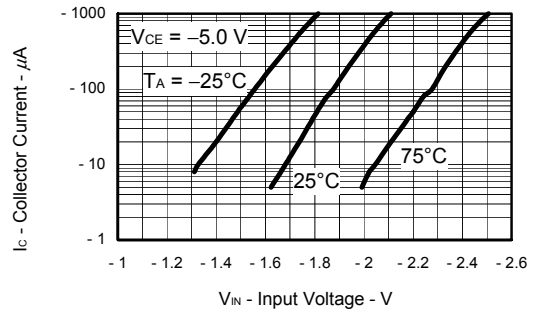

RESISTOR vs. AMBIENT TEMPERATURE

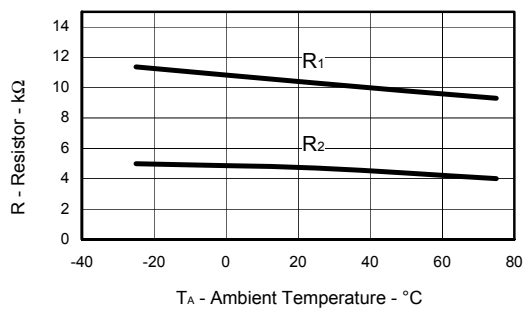

[KN4L4K]  
TYPICAL CHARACTERISTICS (T<sub>A</sub> = 25°C)

COLLECTOR CURRENT vs. COLLECTOR TO EMITTER VOLTAGE

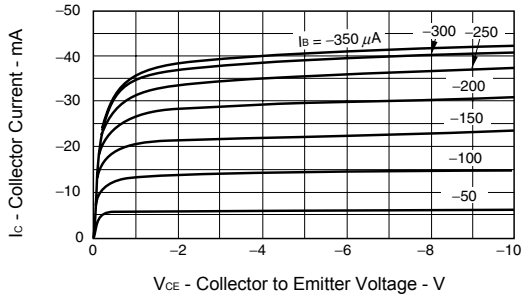

COLLECTOR TO EMITTER VOLTAGE vs. COLLECTOR CURRENT

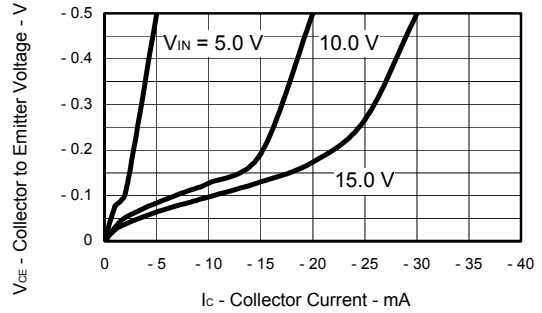

DC CURRENT GAIN vs. COLLECTOR CURRENT

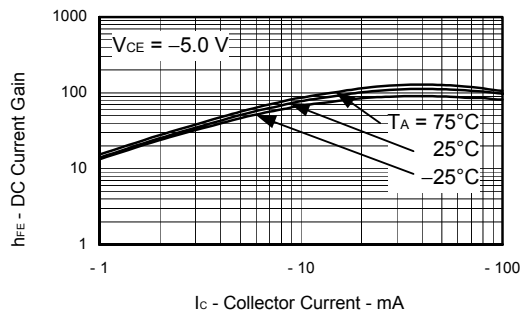

COLLECTOR SATURATION VOLTAGE vs. COLLECTOR CURRENT

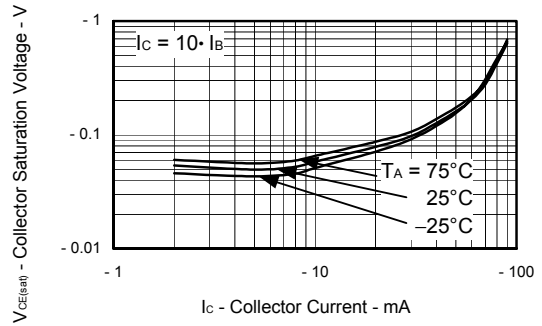

INPUT VOLTAGE vs. COLLECTOR CURRENT

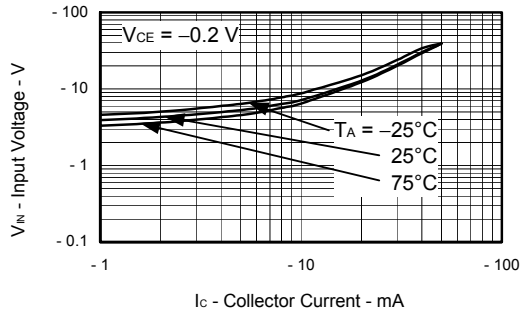

COLLECTOR CURRENT vs. INPUT VOLTAGE

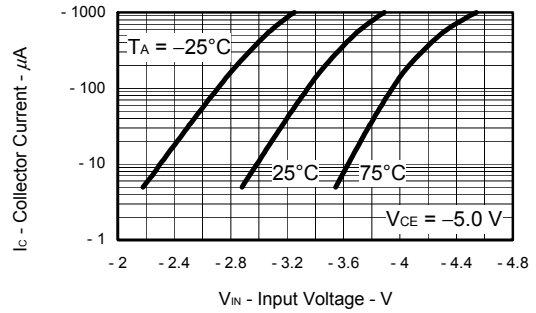

RESISTOR vs. AMBIENT TEMPERATURE

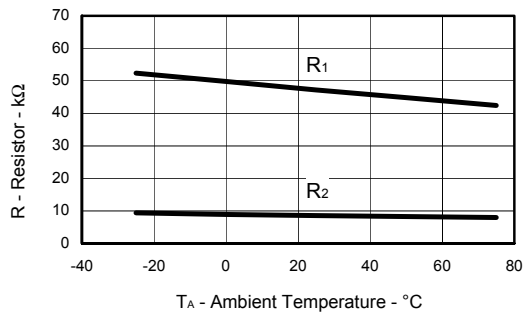

• **The information in this document is current as of October 2004. The information is subject to change without notice. For actual design-in, refer to the latest publications of NEC Electronics data sheets or data books, etc., for the most up-to-date specifications of NEC Electronics products. Not all products and/or types are available in every country. Please check with an NEC Electronics sales representative for availability and additional information.**

• No part of this document may be copied or reproduced in any form or by any means without the prior written consent of NEC Electronics. NEC Electronics assumes no responsibility for any errors that may appear in this document.

• NEC Electronics does not assume any liability for infringement of patents, copyrights or other intellectual property rights of third parties by or arising from the use of NEC Electronics products listed in this document or any other liability arising from the use of such products. No license, express, implied or otherwise, is granted under any patents, copyrights or other intellectual property rights of NEC Electronics or others.

• Descriptions of circuits, software and other related information in this document are provided for illustrative purposes in semiconductor product operation and application examples. The incorporation of these circuits, software and information in the design of a customer's equipment shall be done under the full responsibility of the customer. NEC Electronics assumes no responsibility for any losses incurred by customers or third parties arising from the use of these circuits, software and information.

• While NEC Electronics endeavors to enhance the quality, reliability and safety of NEC Electronics products, customers agree and acknowledge that the possibility of defects thereof cannot be eliminated entirely. To minimize risks of damage to property or injury (including death) to persons arising from defects in NEC Electronics products, customers must incorporate sufficient safety measures in their design, such as redundancy, fire-containment and anti-failure features.

• NEC Electronics products are classified into the following three quality grades: "Standard", "Special" and "Specific".

The "Specific" quality grade applies only to NEC Electronics products developed based on a customer-designated "quality assurance program" for a specific application. The recommended applications of an NEC Electronics product depend on its quality grade, as indicated below. Customers must check the quality grade of each NEC Electronics product before using it in a particular application.

"Standard": Computers, office equipment, communications equipment, test and measurement equipment, audio and visual equipment, home electronic appliances, machine tools, personal electronic equipment and industrial robots.

"Special": Transportation equipment (automobiles, trains, ships, etc.), traffic control systems, anti-disaster systems, anti-crime systems, safety equipment and medical equipment (not specifically designed for life support).

"Specific": Aircraft, aerospace equipment, submersible repeaters, nuclear reactor control systems, life support systems and medical equipment for life support, etc.

The quality grade of NEC Electronics products is "Standard" unless otherwise expressly specified in NEC Electronics data sheets or data books, etc. If customers wish to use NEC Electronics products in applications not intended by NEC Electronics, they must contact an NEC Electronics sales representative in advance to determine NEC Electronics' willingness to support a given application.

(Note)

(1) "NEC Electronics" as used in this statement means NEC Electronics Corporation and also includes its majority-owned subsidiaries.

(2) "NEC Electronics products" means any product developed or manufactured by or for NEC Electronics (as defined above).