

SMD Transient Voltage Suppressors

Table of contents



Table of Contents.....	1-1
Introduction.....	2-2
Transient Voltage Suppressors.....	3-3
Information for Designer.....	4-5
Multilayer varistor introduction	6-6
Part number identification	7-7
ML - A Series High surge protection.....	8-8
ML - C Series Classification.....	9-11
CH Series.....	12-12
ESD solution protection varistor.....	13-13
Array Varistor.....	14-14
MOV Disc Varistor protection.....	15-15
New development item	16-16
Package information.....	17-17
Typical application	18-18
Test information.....	19-19
Reliability experiment.....	20-20
Recommendation for soldering.....	21-22
Cross reference	23-24

SMD Transient Voltage Suppressors

Introduction



Company Profile

SFI, is the trading mark and logo of **SFI Groups**, which are established under the spiritual concept of "*Innovation, Services, Quality, and sincerity*". There are three subsidiary companies under SFI Groups, including **Sun Flower semiconductor Co., Ltd** established in Aug 1999 (known as Sun Flower Instruments Inc. established in 1984) is responsible for the production mainly on mono-chip, multilayer chip TVS, advanced varistors etc. and the nearly completed brand factory, **Leader Well Technology Co., Ltd** for satisfying the tremendous supplies of the worldwide demand on the varistor in the new century, and the mission of **SFI Electronics Technology Inc** is responsible for the marketing and sales under the independent responsibilities on production, marketing and sales.

Advanced Techniques Applied

In order to meet the market trend and fast market change, we build our R&D team to control the reliability and stability of the products. We have been utilizing the advanced material and manufacturing techniques on producing the electronic elements and parts. In Taiwan, we are the first company to launch the Zinc Oxide (ZnO) based Ceramic Semiconductor devices with full range and with the highly advanced multilayer formation technologies to apply the high density circuit assemblies. We obtained many kinds of patents and awards for excellent product designs, and had been selected by government to attend the international trade fair on behalf of Taiwan.

Our SFI varistors and TVSs reliably protect the electronics systems from overvoltages by limiting surge voltages and by absorbing energy. They are used to safeguard the components, to ensure electromagnetic compatibility and suppress the transients caused by electrostatic discharge. In other words they have the added advantage of greater surge current and energy handling capabilities as well as EMI/RFI attenuation. SFI varistors and TVSs have established themselves as a secure and low-cost means of protection in general-purpose use.

SMD Transient Voltage Suppressors



Transient Voltage Suppressor

Major Additions and Improvements

Multilayer Surface Mount Transient Voltage Suppressors (TVS) are manufactured from semiconducting ceramics by the highly advanced multilayer formation technologies, which can offer rugged protection, excellent transient energy absorption and internal heat dissipation. The devices are leadless chip form, eliminating lead inductance and guaranteeing a faster speed of response time of less than 0.5ns, which makes them fast enough to ensure reliable protection against ESD pulse and other specific transient events. These transient suppression devices are significantly smaller footprints and lower profiles than traditional zener diodes or radial MOVs,

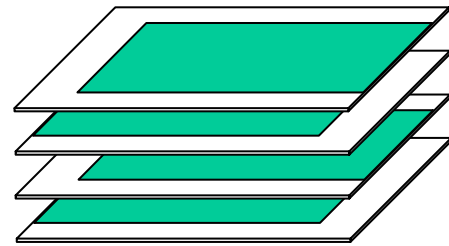

multilayer formation technologies

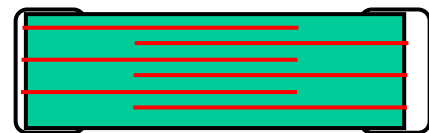
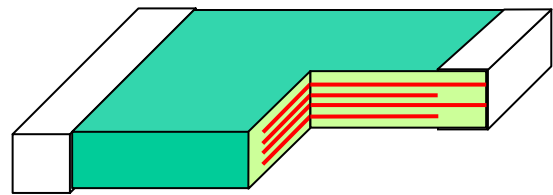

Section of the chip

Material:

1. Body material: ZnO
2. Termination: electrode termination is Ag/Ni/Sn

SMD Transient Voltage Suppressors



Information for Designer

Voltage Dependent Characteristic

Transient Voltage Suppressors (varistors) are voltage-dependent electrical resistors with symmetrical V/I characteristic and the breakdown region, their resistance value decreases with increasing voltage, thus “short-circuiting” further rises in overvoltage.

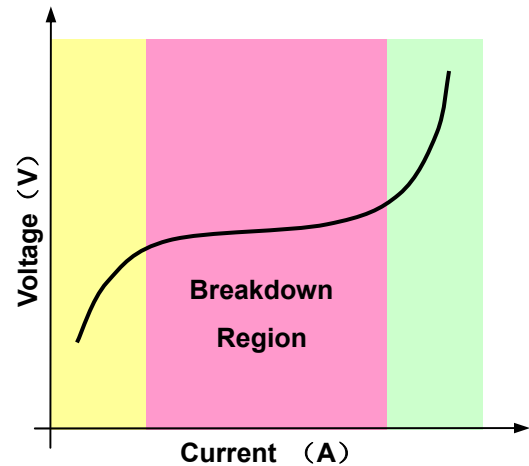

The Prevention of Overvoltage

In other words, as long as the voltage increases above the threshold of the TVS, the suppressor will draw a rapidly increasing current, and then the overvoltage is considerably attenuated away from the protected circuit, that is why the inherent protection of the equipments should be supplemented by including specific components that will raise the withstand capabilities to the required level. Varistors provide protection against all kinds of overvoltage and prevent electronic equipment from being damaged by transient events.

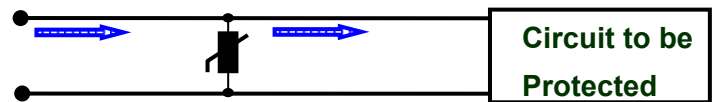

Normal State

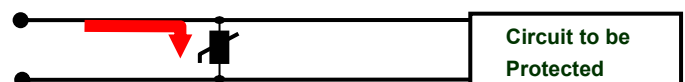

Overvoltage State

SMD Transient Voltage Suppressors



Information for Designer

When selecting the TVS for designing within the circuit, some characteristic parameter should be considered carefully to meet the circuit condition. The following guideline are recommended.

1. The surge handling ability of the selected TVS should meet the need of dissipating the expected transient surge current of the protected circuit.
2. The clamping voltage of the selected TVS should be less than the maximum allowed operating voltage of the protected circuit.
3. In high speed data transmission situation. the capacitance of the selected TVS should be considered.
4. The special requests of the TVS's capacitance such as ESD prevention are available, please contact with us.
5. While choosing the TVS, the working voltage of the TVS should be greater than or equal to the normal operating voltage of the circuit.

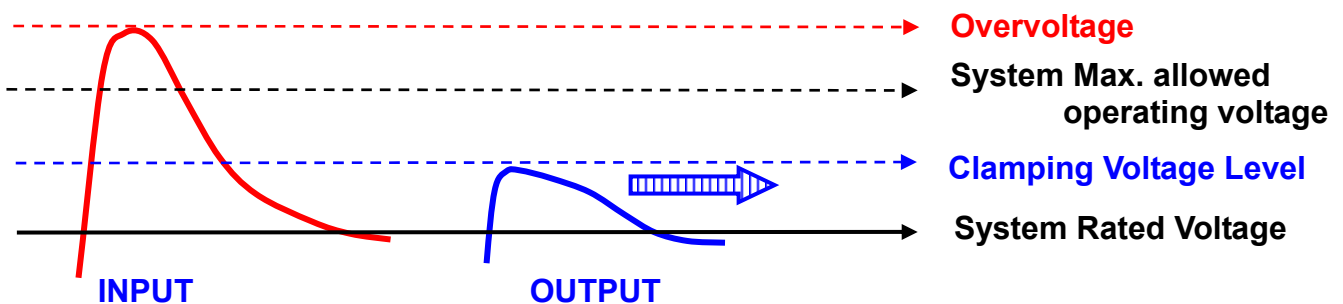
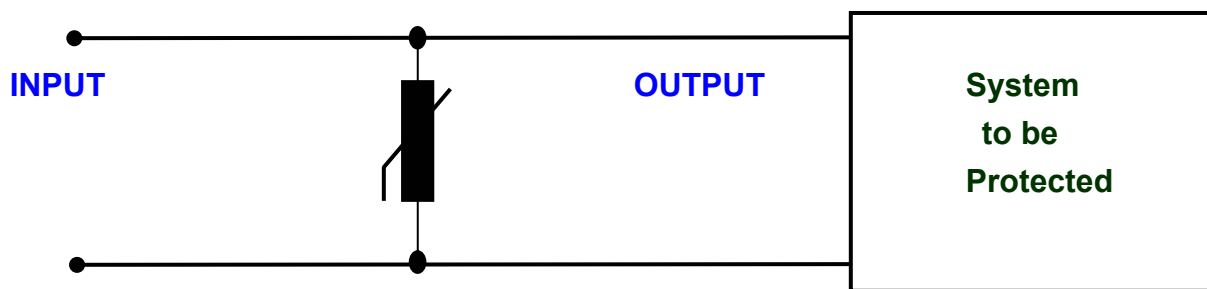

6. Protection Principle : When the voltage increase above the threshold of the varistor, the suppressor draws a rapidly increasing current. The the overvoltage is considerably attenuated.

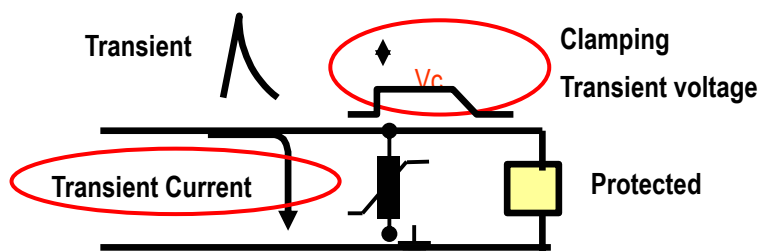

SMD Transient Voltage Suppressors



The Introduction of Multilayer Surface Varistor

Feature

- ◎ Full range from 0402 to 3220 series
- ◎ Working Voltage from 2.5 to 300 V_{RMS}; 3.3 to 385 Vdc
- ◎ High surge current ability
- ◎ Bidirectional clamping, high energy
- ◎ Fast response time
- ◎ Suitable for ESD Protection
- ◎ Low capacitance design (2.5pf) for fast data transmission
- ◎ Array type design
- ◎ Very low leakage current
- ◎ Good solderability

1. MLC Series: Multilayer surface mount for wide range applications

2. MLA Series Multilayer surface mount design for high energy and surge application

3. CH Series Multilayer surface mount design for high voltage suppressor, the working voltage could be up to 385Vdc

4. ESD Series Low capacitance design for high data transmission

5. Array Series

6. MOV Series Disc type design

Type	L mm	W mm	D mm	E mm
0402	1.0 ± 0.10	0.5 ± 0.10	0.6 max	0.25+0.1/-0.1
0603	1.6 ± 0.15	0.8 ± 0.15	0.9 max	0.3+0.1/-0.1
0805	2.0 ± 0.20	1.25 ± 0.15	1.0 max	0.3+0.1/-0.1
1206	3.2 ± 0.20	1.6 ± 0.15	1.2 max.	0.5 +0.2/-0.2
1210	3.2 ± 0.20	2.5 ± 0.20	1.5 max.	0.5 +0.2/-0.2
1812	4.5 ± 0.20	3.2 ± 0.20	2.0 max.	0.5 +0.3/-0.1
2220	5.7 ± 0.20	5.0 ± 0.20	2.5 max.	0.5 +0.3/-0.1

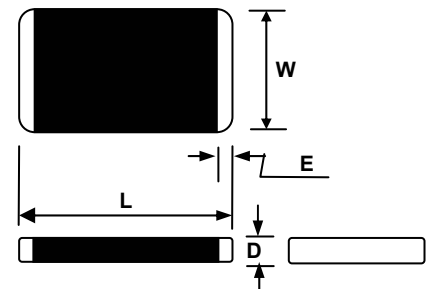

SMD Transient Voltage Suppressors

ML Series Part Number Identification



1. ML Series

SFI **1206** **ML** **240** **C**

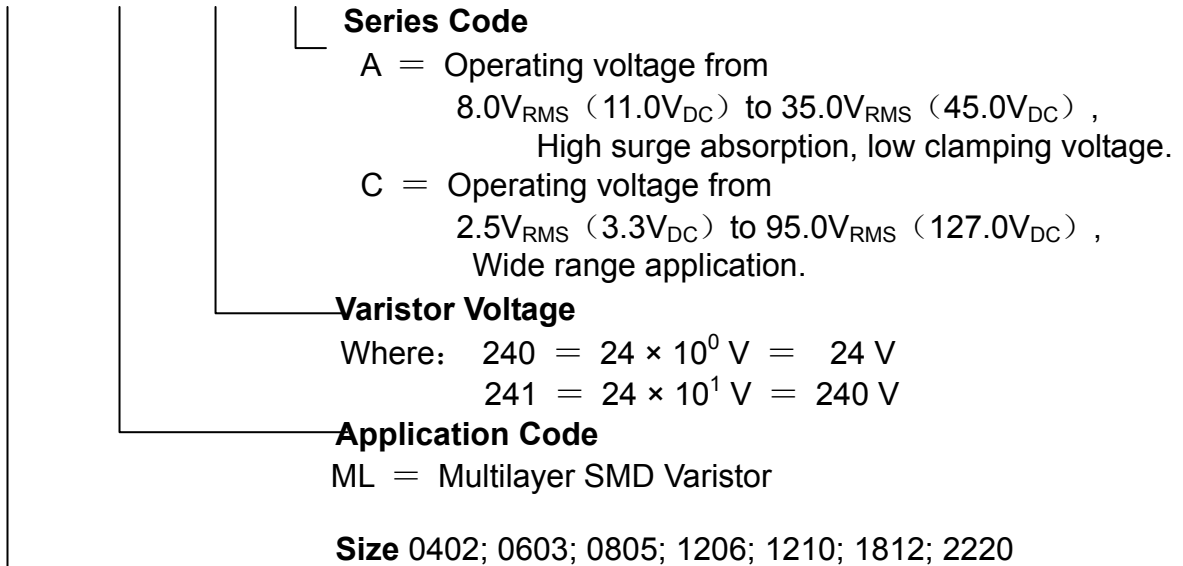

2. ESD Series Part Number Identification

SFI **0402 - 050** **E** **220** **N** **P**

Company Logo

Package :

Mark	Type
P	Taping
C	normal

Size :

Unit mm

Model	0402 Series	0603 Series
Length(L)	1.0 ±0.15	1.60 ±0.15
Width(W)	0.50 ±0.15	0.80 ±0.15
Thickness(T)	0.6 Max	0.9 Max
Termination(a)	0.25 ±0.1	0.3 ±0.1

Cap. Tolerance :

Mark	Range
N	±30%
P	+80%-20%

Exception under 5PF

Cap. Value :

Where 220 = 22 × 10⁰ = 22(pF)

Where 2R5 = 2.5 × 10⁰ = 2.5(pF)

Series :

ESD Protect Solution

MAX

Working Voltage :

Mark	Voltage
050	5V
120	12V
240	24V

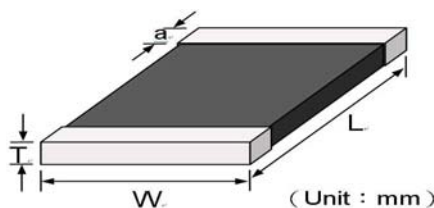

SMD Transient Voltage Suppressors

High surge protection varistor A-series



SFI Model Number	Working Voltage (MAX)		Breakdown Voltage	Peak Current (MAX)	Clamping Voltage (MAX)		Energy Absorption (MAX)	Typical Capacitance ※	
	Unit Condition	AC (V _{RMS})			DC (V)	1mA (V)			8/20μs (A)
SFI1206ML180A		11.0	14.0	18(15.3~20.7)	200	1	30	0.5	1500
SFI1206ML240A		14.0	18.0	24(21.6~27)	200	1	39	0.5	1160
SFI1206ML270A		17.0	22.0	27(24.3~29.8)	200	1	44	0.6	1080
SFI1206ML330A		20.0	26.0	33(29.7~36.3)	200	1	54	0.7	680
SFI1206ML390A		25.0	30.0	39(35.1~42.9)	200	1	65	1.0	620
SFI1206ML470A		30.0	38.0	47(42.3~51.7)	200	1	77	1.1	550
SFI1206ML560A		35.0	45.0	56(50.4~61.6)	200	1	90	0.8	400
SFI1210ML150A		8.0	11.0	15(12.75~17.25)	400	2.5	25	1.0	4050
SFI1210ML180A		11.0	14.0	18 (15.3~20.7)	400	2.5	30	1.2	3860
SFI1210ML240A		14.0	18.0	24 (21.6~27)	400	2.5	39	1.4	2380
SFI1210ML270A		17.0	22.0	27 (24.3~29.8)	400	2.5	44	1.7	2100
SFI1210ML330A		20.0	26.0	33(29.7~36.3)	400	2.5	54	1.9	1400
SFI1210ML390A		25.0	30.0	39(35.1~42.9)	400	2.5	65	1.7	1180
SFI1210ML470A		30.0	38.0	47(42.3~51.7)	400	2.5	77	2.0	1000
SFI1210ML560A		35.0	45.0	56(50.4~61.6)	400	2.5	90	2.0	660
SFI1812ML180A		11.0	14.0	18 (15.3~20.7)	800	5	30	1.9	7030
SFI1812ML240A		14.0	18.0	24 (21.6~27)	800	5	38	2.3	4650
SFI1812ML270A		17.0	22.0	27(24.3~29.8)	800	5	44	2.7	4150
SFI1812ML330A		20.0	26.0	33(29.7~36.3)	800	5	54	3.0	3400
SFI1812ML390A		25.0	30.0	39(35.1~42.9)	800	5	65	3.7	2950
SFI1812ML470A		30.0	38.0	47(42.3~51.7)	800	5	77	4.2	2550
SFI1812ML560A		35.0	45.0	56(50.4~61.6)	800	5	90	4.2	2400
SFI2220ML180A		11	14	18(15.3~20.7)	1200	10	30	5.4	17000
SFI2220ML240A		14	18	24(21.6~27)	1200	10	39	5.8	13600
SFI2220ML270A		17	22	27(24.3~29.8)	1200	10	44	7.2	12000
SFI2220ML330A		20	26	33(29.7~36.3)	1200	10	54	7.8	10500
SFI2220ML390A		25	30	39(35.1~42.9)	1200	10	65	9.6	8900
SFI2220ML470A		30	38	47(42.3~51.7)	1200	10	77	12.0	5700

SMD Transient Voltage Suppressors

Surface Mount Multi layer C Series



SFI Model Number	Working Voltage (MAX)		Breakdown Voltage	Peak Current (MAX)	Clamping Voltage (MAX)		Energy Absorption (MAX)	Typical Capacitance ※
	AC (V _{RMS})	DC (V)			1mA (V)	8/20μs (A)		
SFI0402ML050C	2.5	3.3	5(4.0~6.0)	20	1	12	0.05	390
SFI0402ML080C	4	5.5	8(6.4~9.6)	20	1	18	0.05	295
SFI0402ML120C	6	9	12(10.2~13.8)	20	1	20	0.05	190
SFI0402ML150C	8	11	15(12.75~17.25)	20	1	25	0.05	160
SFI0402ML180C	11	14	18(15.3~20.7)	20	1	30	0.05	135
SFI0402ML220C	12	16.5	22(19.8~24.2)	20	1	36	0.05	105
SFI0402ML240C	14	18	24(21.6~26.4)	20	1	40	0.05	93
SFI0402ML270C	17	22	27(24.3~29.7)	20	1	45	0.05	75
SFI0402ML330C	20	26	33(29.7~36.3)	20	1	54	0.05	54
SFI0402ML390C	25	30	39(35.1~42.9)	20	1	65	0.05	45
SFI0603ML050C	2.5	3.3	5(4.0~6.0)	30	1	12	0.1	1250
SFI0603ML080C	4	5.5	8(6.4~9.6)	30	1	18	0.1	800
SFI0603ML120C	6	9	12(10.2~13.8)	30	1	20	0.1	680
SFI0603ML150C	8	11	15(12.75~17.25)	30	1	25	0.1	460
SFI0603ML180C	11	14	18(15.3~20.7)	30	1	30	0.1	350
SFI0603ML240C	14	18	24(21.6~26.4)	30	1	39	0.1	270
SFI0603ML270C	17	22	27(24.3~29.7)	30	1	44	0.1	235
SFI0603ML330C	20	26	33(29.7~36.3)	30	1	54	0.1	200
SFI0603ML390C	25	30	39(35.1~42.9)	30	1	65	0.1	120
SFI0603ML470C	30	38	47(42.3~51.7)	30	1	77	0.1	100
SFI0603ML560C	35	45	56(50.4~61.6)	30	1	90	0.1	80
SFI0805ML080C	4	5.5	8(6.4~9.6)	80	1	18	0.1	1600
SFI0805ML120C	6	9	12(10.2~13.8)	80	1	20	0.1	1180
SFI0805ML150C	8	11	15(12.75~17.25)	100	1	25	0.1	1050
SFI0805ML180C	11	14	18(15.3~20.7)	100	1	30	0.1	750
SFI0805ML240C	14	18	24(21.6~26.4)	100	1	39	0.2	550
SFI0805ML270C	17	22	27(24.3~29.7)	100	1	44	0.2	400
SFI0805ML330C	20	26	33(29.7~36.3)	100	1	54	0.3	350
SFI0805ML390C	25	30	39(35.1~42.9)	100	1	65	0.3	310
SFI0805ML470C	30	38	47(42.3~51.7)	100	1	77	0.3	280
SFI0805ML560C	35	45	56(50.4~61.6)	80	1	90	0.3	195

SMD Transient Voltage Suppressors



Surface Mount Multi layer C Series

SFI Model Number	Working Voltage (MAX)		Breakdown Voltage	Peak Current (MAX)	Clamping Voltage (MAX)		Energy Absorption (MAX)	Typical Capacitance ※
	AC (V _{RMS})	DC (V)			1mA (V)	8/20μs (A)		
SFI1206ML080C	4	5.5	8(6.4~9.6)	100	1	18	0.2	3200
SFI1206ML120C	6	9	12(9.6~13.8)	100	1	20	0.2	2200
SFI1206ML150C	8	11	15(12.75~17.25)	100	1	25	0.2	1300
SFI1206ML180C	11	14	18(15.3~20.7)	100	1	30	0.3	1150
SFI1206ML240C	14	18	24(21.6~26.7)	100	1	38	0.3	900
SFI1206ML270C	17	22	27(24.3~29.7)	100	1	44	0.4	840
SFI1206ML330C	20	26	33(29.7~36.3)	100	1	54	0.5	490
SFI1206ML390C	25	30	39(35.1~42.9)	100	1	65	0.6	440
SFI1206ML470C	30	38	47(42.3~51.7)	100	1	77	0.7	400
SFI1206ML560C	35	45	56(50.4~61.6)	100	1	90	0.8	310
SFI1206ML680C	40	56	68(61.2~74.8)	100	1	110	1.0	280
SFI1206ML820C	50	65	82(73.8~90.2)	100	1	135	0.5	240
SFI1206ML101C	60	85	100(90~110)	100	1	165	0.6	160
SFI1210ML120C	6	9	12(10.2~13.8)	250	2.5	20	0.5	4400
SFI1210ML150C	8	11	15(12.75~17.25)	250	2.5	25	0.6	3520
SFI1210ML180C	11	14	18(15.3~20.7)	250	2.5	30	0.7	3260
SFI1210ML240C	14	18	24(21.6~26.4)	250	2.5	38	0.8	1950
SFI1210ML270C	17	22	27(24.3~29.7)	250	2.5	44	1.0	1720
SFI1210ML330C	20	26	33(29.7~36.3)	250	2.5	54	1.2	1090
SFI1210ML390C	25	30	39(35.1~42.9)	250	2.5	65	1.4	920
SFI1210ML470C	30	38	47(42.3~51.7)	250	2.5	77	1.6	780
SFI1210ML560C	35	45	56(50.4~61.6)	250	2.5	90	2.0	470
SFI1210ML680C	40	56	68(61.2~74.8)	250	2.5	110	2.3	390
SFI1210ML820C	50	65	82(73.8~90.2)	250	2.5	135	1.2	320
SFI1210ML101C	60	85	100(90~110)	200	2.5	165	1.4	220

SMD Transient Voltage Suppressors

Surface Mount Multi layer C Series



SFI Model Number	Working Voltage (MAX)		Breakdown Voltage	Peak Current (MAX)	Clamping Voltage (MAX)		Energy Absorption (MAX)	Typical Capacitance ※
	AC (V _{RMS})	DC (V)			1mA (V)	8/20μs (A)		
SFI1812ML120C	6	9	12(10.2~13.8)	500	5	20	0.9	9150
SFI1812ML150C	8	11	15(12.75~17.25)	500	5	25	1.2	7320
SFI1812ML180C	11	14	18(15.3~20.7)	500	5	30	1.4	6100
SFI1812ML240C	14	18	24(21.6~26.4)	500	5	38	1.7	3930
SFI1812ML270C	17	22	27(24.3~29.7)	500	5	44	2.0	3500
SFI1812ML330C	20	26	33(29.7~36.3)	500	5	54	2.5	2900
SFI1812ML390C	25	30	39(35.1~42.9)	500	5	65	2.9	2500
SFI1812ML470C	30	38	47(42.3~51.7)	500	5	77	3.5	2200
SFI1812ML560C	35	45	56(50.4~61.6)	500	5	90	4.2	1950
SFI1812ML680C	40	56	68(61.2~74.8)	500	5	110	4.8	1650
SFI1812ML820C	50	65	82(73.8~90.2)	400	5	135	4.5	1060
SFI2220ML120C	6	9	12(10.2~13.8)	1000	10	20	1.9	36500
SFI2220ML150C	8	11	15(12.75~17.25)	1000	10	25	2.3	18400
SFI2220ML180C	11	14	18(15.3~20.7)	1000	10	30	2.7	15300
SFI2220ML240C	14	18	24(21.6~26.4)	1000	10	38	3.1	11800
SFI2220ML270C	17	22	27(24.3~29.7)	1000	10	44	3.8	10400
SFI2220ML330C	20	26	33(29.7~36.3)	1000	10	54	4.3	8900
SFI2220ML390C	25	30	39(35.1~42.9)	1000	10	65	5.5	7500
SFI2220ML470C	30	38	47(42.3~51.7)	1000	10	77	6.3	4600
SFI2220ML560C	35	45	56(50.4~61.6)	1000	10	90	7.7	4000
SFI2220ML680C	40	56	68(61.2~74.8)	1000	10	110	8.8	3500
SFI2220ML820C	50	65	82(73.8~90.2)	800	10	135	5.6	2850

SMD Transient Voltage Suppressors



The Introductions of High Voltage Varistor

MODEL NUMBER	MAXIMUM RATING(TA=125°C)				CHARACTERISTICS(TA=25°C)				Thickness T± 1
	MAX. ALLOWABLE VOLTAGE		SURGE CURRENT	ENERGY ABSORPTION (10/1000µs)	MAX. CLAMPING VOLTAGE		VARISTOR VOLTAGE	TYPICAL CAPACITANCE	
SFI Model Number	AC(V _{RMS})	DC(V)	8/20µs(A)	(J)	(A)	(V)	(V)	pF(KHz)	(mm)
08CH180L	11	14	250	0.8	5	40	18(15.3~20.7)	3300	1.5
08CH220L	14	18	250	0.8	5	46	22(18.7~25.3)	1750	1.5
08CH270L	17	22	250	1.0	5	56	27(22.95~31.05)	1500	1.5
08CH330L	20	26	250	1.2	5	67	33(28.05~37.95)	1200	1.5
08CH390K	25	31	250	1.4	5	76	39(35.1~42.9)	820	1.5
08CH470K	30	38	250	1.8	5	90	47(42.3~51.7)	660	1.5
08CH560K	35	45	250	2.3	5	106	56(50.4~61.6)	530	2.0
08CH680K	40	56	250	3.0	5	124	68(61.2~74.8)	360	2.0
08CH820K	50	65	500	4.0	10	135	82(74~90)	250	1.5
08CH101K	65	85	500	5.0	10	165	100(90~110)	225	1.5
08CH121K	75	102	500	6.0	10	198	120(108~132)	200	1.5
08CH151K	95	127	500	8.0	10	248	150(135~165)	150	1.5
08CH181K	115	153	500	12.0	10	292	180(162~198)	110	1.5
08CH201K	130	175	500	13.0	10	340	200(180~220)	100 *	1.5
08CH221K	140	180	500	14.0	10	356	220(198~242)	94 *	1.5
08CH241K	150	200	500	15.0	10	390	240(216~264)	86 *	1.5
08CH271K	175	225	500	16.0	10	450	270(243~297)	76 *	1.5
08CH301K	190	250	500	17.0	10	495	300(270~330)	64 *	1.5
08CH331K	210	275	500	18.0	10	545	330(297~363)	52 *	1.5
08CH361K	230	300	500	19.0	10	593	360(324~396)	45 *	2.0
08CH391K	250	330	500	20.0	10	647	390(351~429)	42 *	2.0
08CH431K	275	369	450	19.0	10	705	430(387~473)	39 *	2.0
08CH471K	300	385	400	18.0	10	775	470(423~517)	35 *	2.0

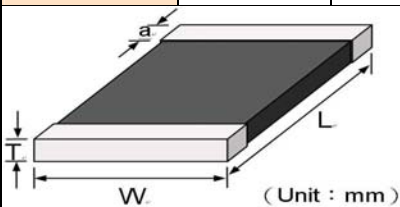

Type	Length	Width	Electrode
08CH (mm)	8.1± 0.30	5.0± 0.30	0.8+0.5/-0.1
3220 (inch)	0.315± 0.012	0.196 ± 0.012	0.0315+0.02/-0.004

CH Series is the high voltage protection for use in hybrid circuit application in Industrial or power supply equipment utilizing surface mount devices. These devices have significantly lower profiles than radial lead varistor. Protection for 14Vdc to 460Vdc and more higher voltage protection.

SMD Transient Voltage Suppressors

ESD Solutions suppressor series



Electro Static discharge (ESD) is the transients as short duration excursion. Our ESD products are based on Multilayer fabrication technology design to suppress ESD events. Our products meets IEC61000-4-2 standard for Electromagnetic Compliance testing. We supply extra low capacitance and protect integrated circuits protection

Feature

- Fast Response < 0.5nS
- Low Working Voltage 3.3V
- Low Capacitance 2.5pF
- Low Leakage Current < 0.1 uA
- Low Clamping Voltage

Specification (for 0402 and 0603 size) XXXX=0402 or 0603

Part No,	Working Voltage	Clamping Voltage	Leakage Current	Capacitance Volume	Insulation Resistance
(Unit)	VDC (max)	Vclamp(max)	uA(max)	pF	Ohm(Min)
SFIXXXX-050E101NP	5	30	0.1	100	50
SFIXXXX-050E820NP	5	34	0.1	82	50
SFIXXXX-050E560NP	5	34	0.1	56	50
SFIXXXX-050E330NP	5	34	0.1	33	50
SFIXXXX-050E220NP	5	34	0.1	22	50
SFIXXXX-050E100NP	5	34	0.1	10	50
SFIXXXX-050E050PP	5	34	0.1	5~9	50
SFIXXXX-120E101NP	12	34	0.1	100	120
SFIXXXX-120E820NP	12	34	0.1	82	120
SFIXXXX-120E560NP	12	40	0.1	56	120
SFIXXXX-120E330NP	12	40	0.1	33	120
SFIXXXX-120E220NP	12	40	0.1	22	120
SFIXXXX-120E100NP	12	60	0.1	10	120
SFIXXXX-120E050PP	12	80	0.1	4~9	120
SFIXXXX-240E2R5PP	24	198	0.1	2~4	120

1 The MAX Working Voltage is suited for under 24 V including 3.3V、5V、8V、12V。

2.This Clamping Voltage at which the device stabilized during the transition from high to low impedance 8/20 μs waveform current 1A

3. All capacitance test under 1MHz, tolerance at +30%(N) exception under 5pF for +80% -20%。

4. The Leakage current was measured at working voltage 5. The Insulation Resistor was measured at working voltage

SMD Transient Voltage Suppressors

Array Solutions suppressor series



1. Part Number Identification

SFI 0508 - 050 S 200 N P - A 4

Company Logo

Size

Model	0508 Series
Length(L)	2.00 ±0.15mm
Width(W)	1.20 ±0.15mm

Max Working Voltage

S :

Array Type

Channel :
4 - 8 ports

Type : A

Package :

Tolerance :
N ± 30%

Capacitance :
200 = $20 \times 10^0 = 20(\text{PF})$

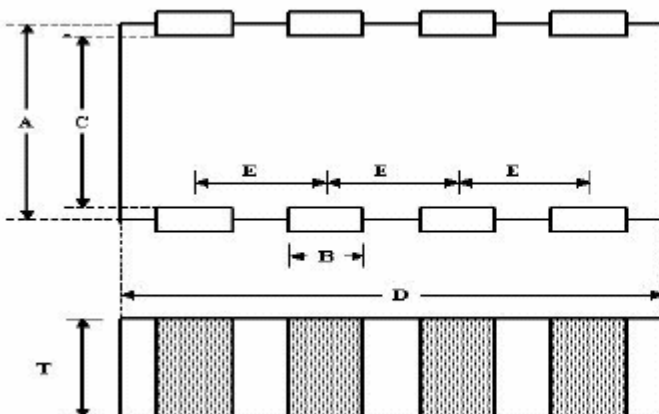

	A4	
	0508	0612
A	1.25 ±0.20	1.60 ±0.20
B	0.25±0.05	0.40 ±0.15
C	1.00 (ref.)	1.40 (ref.)
D	2.00 ±0.20	3.20 ±0.20
E	0.50 (ref.)	0.80 (ref.)
T	0.72 ±0.08	0.85 ±0.10

2. Performance Characteristic

Part Number	Working Voltage	Breakdown Voltage	Clamping Voltage	Leakage Current	Insulation Resistance	Capacitance Value
Symbol	DC (MAX)	$V_{BDV(*1)}$	$V_{(*2)}$	$\mu A_{(*3)}$	M ohm _(*4)	pF _(*5)
SFI0508-050R200NP-A4	5	24	< 50	< 0.1	> 10	20
SFI0508-050R100NP-A4	5	24	< 60	< 0.1	> 10	10
SFI0612-180R121NP-A4	18	27	< 60	< 0.1	> 10	120

* 1 The Breakage Voltage was measured at 1mA DC, tolerance ±30%.

* 2 The Clamping Voltage was measured at 8/20 μs waveform, 1A current.

* 3 The Leakage Current was measured at working voltage.

* 4 The Insulation Resistance was measured at working voltage.

* 5 The Capacitance was measured at 1M Hz, tolerance ±30%.

* 6 Special specification requirement are available upon request, please contact sales for further request.

SMD Transient Voltage Suppressors

Lead type Solutions suppressor series



SFI can also supply the following disc varistor.

SFI Model Number	Element Size (mm)					Working Voltage (MAX)		Breakdown Voltage
	05D	07D	10D	14D	20D	AC	DC	1mA(V)
180K	⊙	⊙	⊙	⊙	⊙	11	14	18 (16~20)
220K	⊙	⊙	⊙	⊙	⊙	14	18	22 (20~24)
270K	⊙	⊙	⊙	⊙	⊙	17	22	27 (24~30)
330K	⊙	⊙	⊙	⊙	⊙	20	26	33 (30~36)
390K	⊙	⊙	⊙	⊙	⊙	25	31	39 (35~43)
470K	⊙	⊙	⊙	⊙	⊙	30	38	47 (42~52)
560K	⊙	⊙	⊙	⊙	⊙	35	45	56 (50~62)
680K	⊙	⊙	⊙	⊙	⊙	40	56	68 (61~75)
820K	⊙	⊙	⊙	⊙	⊙	50	65	82 (74~90)
101K	⊙	⊙	⊙	⊙	⊙	60	85	100 (90~110)
121K	⊙	⊙	⊙	⊙	⊙	75	100	120 (108~132)
151K	⊙	⊙	⊙	⊙	⊙	95	125	150 (135~165)
181K	⊙	⊙	⊙	⊙	⊙	115	150	180 (162~198)
201K	⊙	⊙	⊙	⊙	⊙	130	170	200 (185~225)
221K	⊙	⊙	⊙	⊙	⊙	140	180	220 (198~242)
241K	⊙	⊙	⊙	⊙	⊙	150	200	240 (216~264)
271K	⊙	⊙	⊙	⊙	⊙	175	225	270 (247~303)
301K	⊙	⊙	⊙	⊙	⊙	195	250	300 (270~330)
331K	⊙	⊙	⊙	⊙	⊙	210	270	330 (297~363)
361K	⊙	⊙	⊙	⊙	⊙	230	300	360 (324~396)
391K	⊙	⊙	⊙	⊙	⊙	250	320	390 (351~429)
431K	⊙	⊙	⊙	⊙	⊙	275	350	430 (387~473)
471K	⊙	⊙	⊙	⊙	⊙	300	385	470 (423~517)
511K	⊙	⊙	⊙	⊙	⊙	320	418	510 (459~561)
561K	⊙	⊙	⊙	⊙	⊙	350	460	560 (504~616)
621K		⊙	⊙	⊙	⊙	385	505	620 (558~682)
681K		⊙	⊙	⊙	⊙	420	560	680 (612~748)
751K			⊙	⊙	⊙	460	615	750 (685~825)
781K			⊙	⊙	⊙	485	640	780 (702~858)
821K			⊙	⊙	⊙	510	670	820 (738~902)
911K			⊙	⊙	⊙	550	745	910 (819~1001)
102K			⊙	⊙	⊙	625	825	1000 (900~1100)
112K			⊙	⊙	⊙	680	895	1100 (990~1210)
182K				⊙	⊙	1000	1465	1800 (1620~1980)

NOTES : detail specification please contact sales department

SMD Transient Voltage Suppressors

New Development and product roadmap item



SFI have the strong R&D team to continual producing new overvoltage protection for Customer valued application and circuit protection. We supply customer all series protection from low voltage to high voltage and from single type to array type. Now our product roadmap are including following. More detail schedule and product specification, please contact our sales team for further request.

1. Extra low capacitance (0.5pf) ESD protection

Chip varistor the material is ZnO and the low capacitance need very high technical to production. SFI have the strong technical and our current mass production item capacitance is 2.5pf. We still keep continual making research for under 0.5pf capacitance for customer application.

2. Low voltage Array series type

We are also making develop item of array 0508 and 0612 series for the working voltage lower 12.5V and low capacitance request.

3. ESD and EMI function together Array products

We also making new item of array with EMI function for customer.

SMD Transient Voltage Suppressors

Packaging

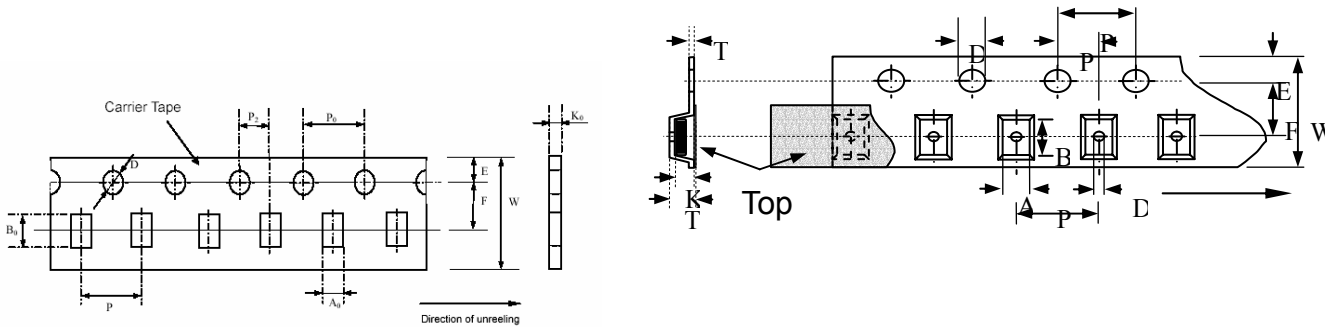

Symbol	A ₀ ±0.10	B ₀ ±0.10	K ₀ ±0.10	T ±0.05	T ₂ ±0.05	D ₀ +0.10 -0.00	D ₁ ±0.05	P ₁ ±0.10	P ₂ ±0.05	P ₀ ±0.05	W ±0.20	E ±0.10	F ±0.05
0402	0.85	1.25	0.65	0.22	0.87	1.50	1.00	3.00	2.00	4.00	8.00	1.75	3.50
0603	1.08	1.88	0.95	0.22	1.17	1.50	1.00	4.00	2.00	4.00	8.00	1.75	3.50
0805	1.42	2.30	1.04	0.22	1.26	1.50	1.00	4.00	2.00	4.00	8.00	1.75	3.50
1206	1.88	3.50	1.27	0.22	1.49	1.50	1.00	4.00	2.00	4.00	8.00	1.75	3.50
1210	2.78	3.46	1.55	0.22	1.77	1.50	1.00	4.00	2.00	4.00	8.00	1.75	3.50
1812	3.66	4.95	1.74	0.25	1.99	1.50	1.50	8.00	2.00	4.00	12.00	1.75	5.50
2220	5.10	5.97	2.80	0.25	3.05	1.50	1.50	8.00	2.00	4.00	12.00	1.75	5.50
08CH	5.50	8.50	2.80	1.00	3.05	1.50	1.50	8.00	2.00	4.00	16.00	1.75	7.50

Unit: mm

Reel Dimensions

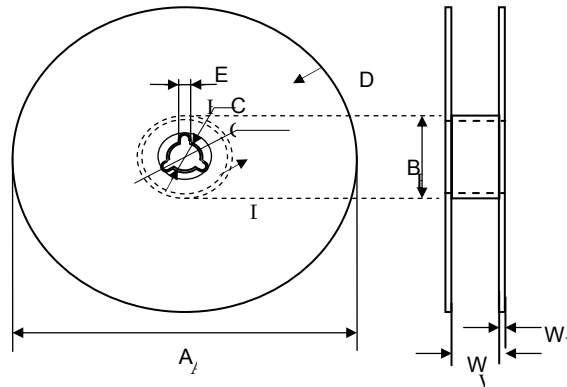

Symbol	A	B	C	D	E	W	W ₁
0402	178.0±1.0	60.0±0.5	13.0±0.2	21.0±0.2	2.0±0.5	9.0±0.50	1.5±0.15
0603	178.0±1.0	60.0±0.5	13.0±0.2	21.0±0.2	2.0±0.5	9.0±0.50	1.5±0.15
0805	178.0±1.0	60.0±0.5	13.0±0.2	21.0±0.2	2.0±0.5	9.0±0.50	1.5±0.15
1206	178.0±1.0	60.0±0.5	13.0±0.2	21.0±0.2	2.0±0.5	9.0±0.50	1.5±0.15
1210	178.0±1.0	60.0±0.5	13.0±0.2	21.0±0.2	2.0±0.5	9.0±0.50	1.5±0.15
1812	178.0±1.0	60.0±0.5	13.5±0.1	21.0±0.2	2.0±0.5	13.6±0.2	1.5±0.15
2220/08CH	178.0±1.0	60.0±0.5	13.5±0.1	21.0±0.2	2.0±0.5	13.6±0.2	1.5±0.15

Pieces packaged per reel Unit mm

Type	0402	0603	0805	1206	1210	1812	2220/08CH
Pcs/reel	10000	4000	3000	3000	2000	1000	1000

SMD Transient Voltage Suppressors



TYPICAL APPLICATION

1. ESD Series suggestion

Device Description	Data Rate & Frequency	Rise time	Capacitance
USB 2.0 Data Port	480 M bps	0.5~0.6 nS	< 4pF
USB1.1 Data Port	12 M bps	4~20 nS	5~56pF
Wireless device	1.5 M bps	75~300 nS	5~56pF
RS232 、 IrDA1.0	115.2 K	1uS~8 uS	10~100pF
Audio (Microphone/Speaker)	20~20K Hz	0.05mS~50 mS	10~100pF

ESD series application field

- Mobile phone
- Digital Camera
- PDA
- Notebook
- MP3 player
- I/O Port, Keypad for portable
- LCD Module
- HUB
- Telecom
- Wireless LAN
- Keyboard

2. ML/CH series application field

- Telecommunication
- Security systems
- Alarm systems
- Medical device and equipment
- Lighting
- AC line protection
- Automotive system
- Controller
- Sensor
- Data Systems
- Power supplier
- IC, Semiconductor
- more application please contact SFI

SMD Transient Voltage Suppressors



Characteristic Definition

◎ Definition

Characteristics	Test Method or Description
Max. Working Voltage	Maximum steady-state DC operating voltage the device can maintain and typical leakage current at 25°C not exceed 50 μ A.
Varistor Voltage (BDV)	With the specified measuring current of 1mA DC applied. Tolerance of breakdown voltage: 5~8V= \pm 20%; 12~18V= \pm 15%; 18~430V= \pm 10%
Max. Clamping Voltage	Maximum peak voltage across the TVS measured at a specified pulse current (A) and waveform 8/20 μ s.
Surge Current	Maximum peak current within the varistor voltage change of \pm 10% may be applied with the specified waveform 8/20 μ s.
Surge Shift $\Delta V/V$	The shift of Varistor voltage after suffering the specified surge current.
Energy Absorption	Maximum energy within the varistor voltage change of \pm 10% may be dissipated with a specified waveform 10/1000 μ s .
Typical Capacitance	Device Capacitance measured with zero voltage bias 0.5V _{RMS} 1KHz; under 100pf measure at 1Mhz; Surge series the capacitance is only for reference.
Nonlinear exponent α	$\alpha = \{ \log (V_{1mA}/V_{0.1mA}) / \log (I_{mA}/I_{0.1mA}) \}$
Leakage Current	Typical leakage current at 25°C < 50 μ A; Maximum leakage 200 μ A;

※Standard Test Condition : Environmental condition under which every measuring is done without doubt on the measuring results. Unless specially specified, temperature, relative humidity are 5 to 35°C, 45 to 85% RH.

※ 8/20 μ s waveform current (A)

※ ESD protection waveform current

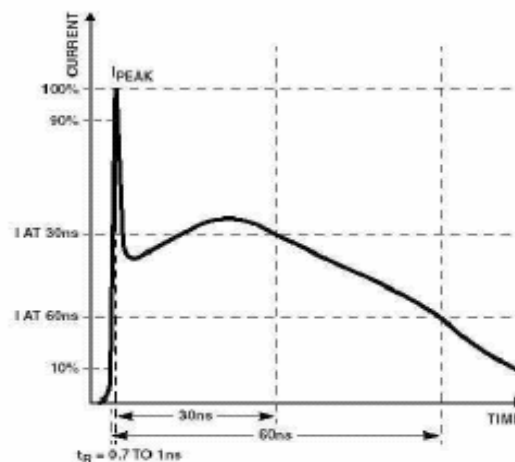
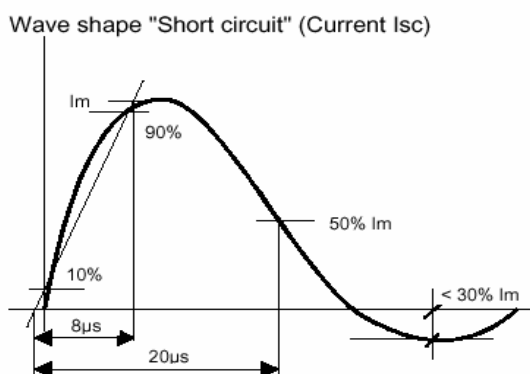

IEC 61000-4-5, EN 61000-4-5,

This generator complies with UL 1449 August 15, 1996 Table B1.1

SMD Transient Voltage Suppressors



Reliability Experiment

Experiment	Test Method and Description			
<i>High Temperature Storage/ Dry Heat</i>	The specimen shall be subjected to $150 \pm 2^{\circ}\text{C}$ for 1000 ± 12 hours in a thermostatic bath without load and then stored at room temperature and humidity for 1 to 2 hours. Therefore, the change of varistor voltage shall be measured.			
<i>Temperature Cycle</i>	The temperature cycle of specified temperature shall be repeated five times and then stored at room temperature and humidity for one or two hours. the change of varistor voltage and mechanical damage shall be examined.	Step	Temperature	Period
		1	-40 ± 3	30Min \pm 3
		2	Room Temperature	1 hour
		3	125 ± 3	30Min \pm 3
4	Room Temperature	1 hours		
<i>High Temperature Load/ Dry Heat Load</i>	After being continuously applied the maximum allowable voltage at $85 \pm 2^{\circ}\text{C}$ for 1000 ± 2 hours, the specimen shall be stored at room temperature and humidity for one or two hours, Therefore the change of varistor voltage should be measured.			
<i>Damp Heat Load/ Humidity Load</i>	The specimen should be subjected to $40 \pm 2^{\circ}\text{C}$, 90 to 95% RH and the maximum allowable voltage for 500 hours and then stored at room temperature and humidity for one or two hours. Therefore the change of varistor voltage should be measured.			
<i>Low Temperature Storage/ Cold</i>	The specimen should be subjected to $-50 \pm 2^{\circ}\text{C}$, without load for 500 hours and then stored at room temperature for one or two hours. Therefore the change of varistor voltage should be measured.			
<i>Direct contact electrostatic discharge</i>	1.Discharge: contact electrostatic discharge; 2.Voltage : 8KV (Level4) 3.Polarity : +,- ; 4.Number: 10 times ; 5.Interval time : 1sec			
<i>Direct air electrostatic discharge</i>	1.Discharge: air electrostatic discharge; 2.Voltage : 15KV (Level4) 3.Polarity : +,-; 4.Number: 10 times; 5.Interval time : 1~ 3sec			

IEC61000-4 Standard

SEVERITY LEVEL	AIR DISCHARGE	DIRECT DISCHARGE
1	2 KV	2 KV
2	4 KV	4 KV
3	8 KV	6 KV
4	15 KV	8 KV

SMD Transient Voltage Suppressors



Recommendation for Soldering

5. Soldering Recommendations

5.1 Recommended solder pad layout

(Unit : mm)

	A	B	C	D
0402	0.4~0.6	1.4~1.8	0.5~0.6	0.6~1.2
0603	0.8~1.2	2.2~2.8	0.6~1.0	0.9~1.5
0805	1.0~1.5	2.6~3.2	1.2~1.5	1.1~1.8
1206	1.8~2.5	4.2~5.2	1.2~1.8	1.2~1.8
1210	1.8~2.5	4.2~5.2	2.2~3.0	1.3~2.0
1812	2.5~3.3	5.5~6.7	2.8~3.6	1.3~2.2
2220	3.8~4.6	6.6~7.8	4.8~5.5	1.3~2.2
08CH	5.2~6.4	9.5~10.8	5.0~6.0	2.0~2.8

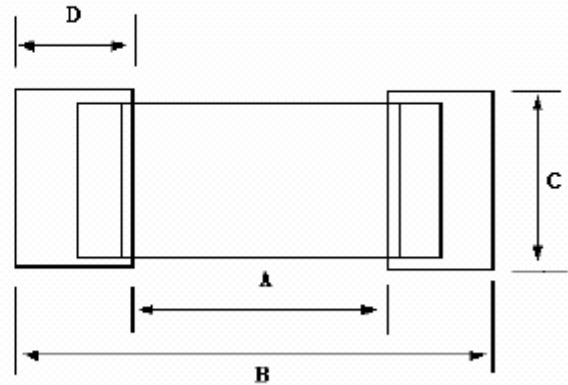

Soldering Recommendations :

Material	Sn/Ag/Cu 96/3.5/0.5 or equivalent
Temperature	260°C, 3 seconds max
Flux	Non Activated.

Recommended soldering temperature profile

1. Reflow Solder Profile

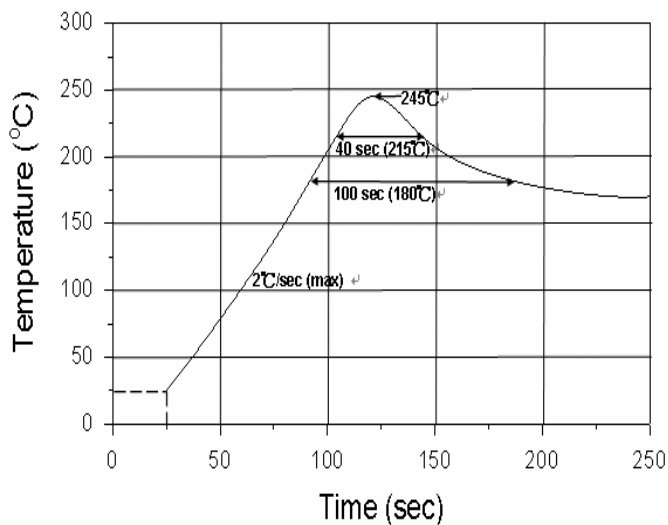

- (a) Preheat
 1. The temperature rising speed is suggested to be 2°C/sec(max).
 2. Appropriate preheat time will be from 60 to 120 seconds.
- (b) Heating
 1. Careful about sudden rise in temperature as it may worsen the solder ability.
 2. Set the peak temperature in the range from 240°C to 245°C.
- (c) Cooling
 1. Careful about slow cooling as it may cause the position shift of component.

SMD Transient Voltage Suppressors



Recommendation for Soldering

2. Major point of SMT reflow

- (a) Solder pad layout : please refer to 5.1
- (b) Steel plate and foot distance printing

Foot distance printing (mm/mils)	Steel Plate thickness (mm)
> 0.65mm/25 mil	0.18mm
0.65mm/25 mils~0.5mm/20mils	0.15mm
0.50mm/20 mils~0.40mm/16mils	0.12mm
<=0.40 mm/16 mils	0.10mm

The IR reflow and temperature of Soldering for Pb Free

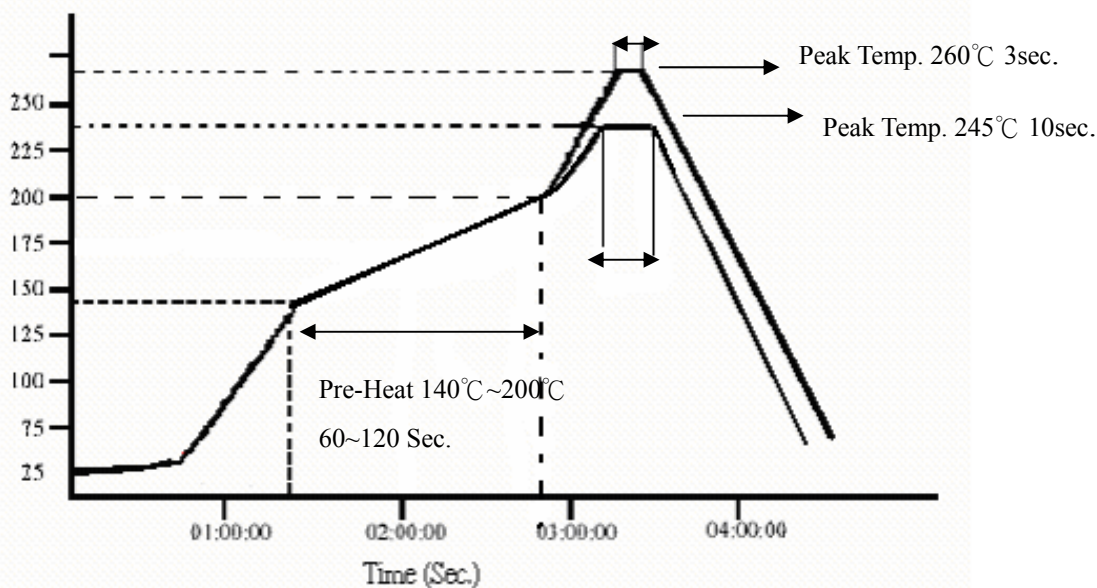

☆ IR reflow Pb Free Process suggestion profile

- (1) Soldering recommend paste is Sn 96.5/Ag 3.5
- (2) Ramp-up rate (217°C to Peak) + 3°C/second max
- (3) Temp. maintain at 175 +/-25°C 180 seconds max
- (4) Temp. maintain above 217 °C 60-150 seconds
- (5) Peak temperature range 245°C +20°C/ -10 °C time within 5 °C of actually peak temperature (tp) 10~20 seconds
- (6) Ramp down rate +6 °C/second max.

※Perform adequate test in advance as the reflow temperature profile will vary according to the conditions of the manufacturing process, and the specification of the reflow furnace.

SMD Transient Voltage Suppressors



Recommendation for Soldering

Recommended Soldering Condition 1

- (1) Solder :
0.12~0.18mm Thread solder (Sn96.5:Ag3.5) with soldering flux in the core.
Rosin-based and non-activated flux is recommended.
- (2) Preheating
The Varistors shall be preheated so that Temperature Gradient between the devices and the tip of soldering iron is 150°C or below.
- (3) Soldering Iron
Rated Power of 20w max with 3mm soldering tip in diameter.
Temperature of soldering iron tip 300°C max (The required amount of solder shall be melted in advance on the soldering tip.)
- (4) Cooling :After soldering. The Varistors shall be cooled gradually at room ambient temperature.

The IR reflow and temperature of Soldering for normal

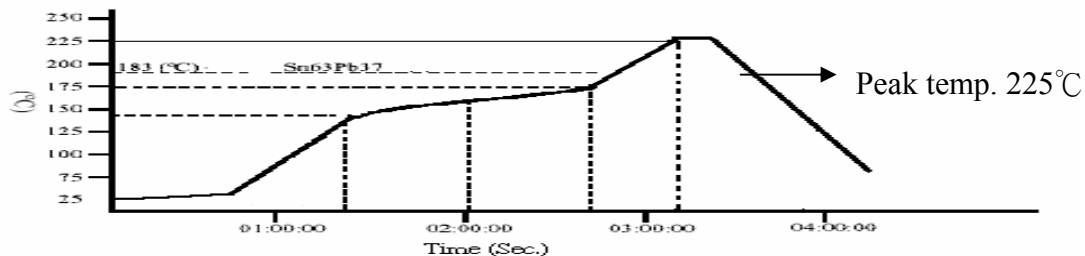

☆ IR reflow Process suggestion profile

- (1) Soldering recommend is **Sn 63: Pb 37**
- (2) Ramp-up rate (183°C to Peak) + 3°C/second max
- (3) Temp. maintain at 125 +/-25°C 120 seconds max
- (4) Temp. maintain above 183 °C 60-150 seconds
- (5) Peak temperature range **225°C +/-10 °C (215°C~235°C)** time within 5 °C of actually peak temperature (tp) 10-20 seconds
- (6) Ramp down rate +6 °C/second max.

※Perform adequate test in advance as the reflow temperature profile will vary according to the conditions of the manufacturing process, and the specification of the reflow furnace.

* Recommended Soldering Condition 1

- (1) Solder :
0.12~0.18mm Thread solder (**Sn63:pb 37**) with soldering flux in the core. Rosin-based and non-activated flux is recommended.
- (2) Preheating
The Varistors shall be preheated so that Temperature Gradient between the devices and the tip of soldering iron is 150°C or below.
- (3) Soldering Iron
Rated Power of 20w max with 3mm soldering tip in diameter.
Temperature of soldering iron tip 300°C max (The required amount of solder shall be melted in advance on the soldering tip.)
- (4) Cooling
After soldering. The Varistors shall be cooled gradually at room ambient temperature.

SMD Transient Voltage Suppressors

SMD Varistor cross reference list



— 0402/0603/0805/Array series

SFI	Amotech	EPCOS	AVX
0402ML080C	AVL5M02200		VC040205X150
0402ML120C	AVL8M02200		VC040209X200
0402ML150C	AVL11L02200		
0402ML180C	AVL14K02200		VC040214X300
0402ML240C	AVL18K02200	CT0402L14G	VC040218X400
0603ML050C	AVL3M03300		VC060303A100
0603ML080C	AVL5M03300	CT0603M4G	VC060305A150
0603ML120C	AVL8M03300	CT0603M6G	VC060309A200
0603ML150C	AVL11L03300	CT0603L8G	
0603ML180C	AVL14K03300	CT0603K11G	VC060314A300
0603ML240C	AVL18K03300	CT0603K14G	VC060318A400
0603ML270C		CT0603K17G	
0603ML330C		CT0603K20G	VC060326A580
0402-050E101NP	AVLC5S02100		
0402-050E560NP	AVLC5S02050		
0402-120E101NP	AVLC14S02100		
0402-120E560NP	AVLC14S02050		
0402-120E100NP	AVLC18S02015		
0402-240E2R5PP	AVLC18S02003		
0603-120E101NP	AVLC18S03120		
0603-120E330NP	AVLC18S03030		
0603-120E100NP	AVLC18S03015		
0603-240E2R5PP	AVLC200S03003		
Array 0508	AVNC18S05Q015		
Array 0612	AVNC18S06Q120		MG064L18X500
0805ML080C	AVL5M05400	CT0805M4G	VC080505A150
0805ML120C		CT0805M6G	VC080509A200
0805ML150C	AVL11L05400		VC080512A250
0805ML180C	AVL14K05400	CT0805K11G	VC080514C300
0805ML240C	AVL18K05400	CT0805K14G	VC080518C400
0805ML270C	AVL22K05400	CT0805K17G	
0805ML330C	AVL26K05400	CT0805K20G	VC080526C580
0805ML390C		CT0805K25G	VC080530A650
0805ML470C		CT0805K30G	

SMD Transient Voltage Suppressors

SMD Varistor cross reference list



二. 1206/1210/1812/2220/08CH series

SFI	Amotech	EPCOS	AVX	SFI	Amotech	EPCOS	AVX
1206ML080C	AVL5M06151	CT1206M4G	VC120605A150	2220ML180C		CN2220K11G	
1206ML120C	AVL8M06151	CT1206M6G		2220ML240C		CN2220K14G	
1206ML150C	AVL11L06151	CT1206L8G		2220ML270C		CN2220K17G	
1206ML180C	AVL14K06151	CT1206K11G	VC120614D300	2220ML330C		CN2220K20G	
1206ML240C	AVL18K06151	CT1206K14G	VC120618D400	2220ML390C		CN2220K25G	
1206ML270C	AVL22K06151	CT1206K17G		2220ML470C		CN2220K30G	
1206ML330C	AVL26K06151	CT1206K20G	VC120626D580	2220ML560C		CN2220K35G	
1206ML390C	AVL31K06151	CT1206K25G		2220ML680C		CN2220K40G	
1206ML470C	AVL38K06151	CT1206K30G	VC120630D650	2220ML820C		CN2220K50G	
1206ML560C	AVL45K06151	CT1206K35G		08CH180L		CU3225K11G2	
1206ML680C	AVL56K06151	CT1206K40G	VC120648D101	08CH240L		CU3225K14G2	
1210ML120C	AVL8M10251	CT1210M6G		08CH330L		CU3225K20G2	
1210ML150C	AVL11L10251	CT1210L8G		08CH390K		CU3225K25G2	
1210ML180C	AVL14K10251	CT1210K11G		08CH470K		CU3225K30G2	
1210ML240C	AVL18K10251	CT1210K14G	VC121018J390	08CH680K		CU3225K40G2	
1210ML270C	AVL22K10251	CT1210K17G		08CH820K		CU3225K50G2	
1210ML330C	AVL26K10251	CT1210K20G	VC121026H560	08CH101K		CU3225K65G2	
1210ML390C	AVL31K10251	CT1210K25G	VC121030G620	08CH121K		CU3225K75G2	
1210ML470C	AVL38K06151	CT1210K30G		08CH151K		CU3225K95G2	
1210ML560C	AVL45K10251	CT1210K35G	VC121048G101	08CH181K		CU3225K115G2	
1210ML680C	AVL56K10251	CT1210K40G		08CH201K		CU3225K130G2	
1812ML180C		CN1812L11G		08CH221K		CU3225K140G2	
1812ML240C		CN1812K14G		08CH241K		CU3225K150G2	
1812ML270C		CN1812K17G		08CH271K		CU3225K175G2	
1812ML330C		CN1812K20G		08CH361K		CU3225K230G2	
1812ML390C		CN1812K25G		08CH391K		CU3225K250G2	
1812ML470C		CN1812K30G		08CH431K		CU3225K275G2	
1812ML560C		CN1812K35G		08CH471K		CU3225K300G2	