

Transistor New Products



CONTENTS

- **MOS FET Series**
- **Low $V_{CE(sat)}$ Miniature Digital Transistor Series**
- **Low $V_{CE(sat)}$ Transistor Series**
- **Endured Discharge Voltage/
High Speed Switching/
Low Noise Transistor Series**
- **Muting Transistor Series**

MOS FET

TUMT/TSMT Series



Application

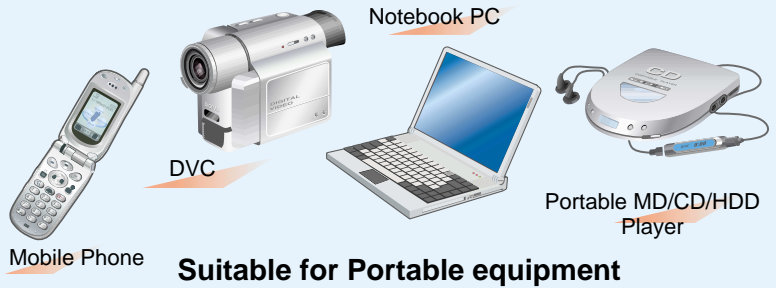

Features

- Realizes low ON-state resistance with even compact packages.
- Offers a line-up of compound products combining two elements with the downsizing of the packages attained, thus contributing to the high-density mounting of the packages.
- Offers a line-up of easy-to-use compound products with Schottky Barrier Diode for power supply applications.

● TSMT

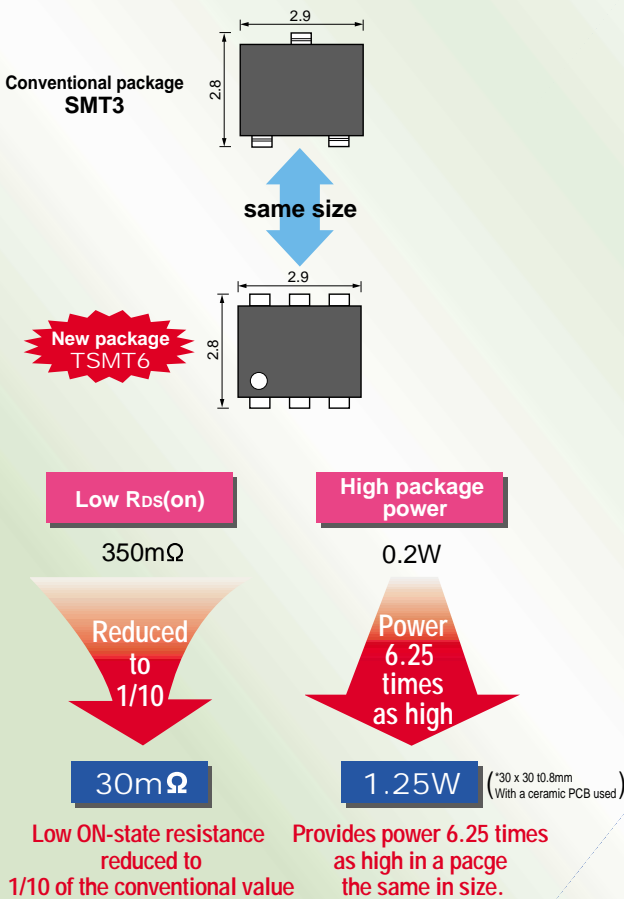

● TUMT

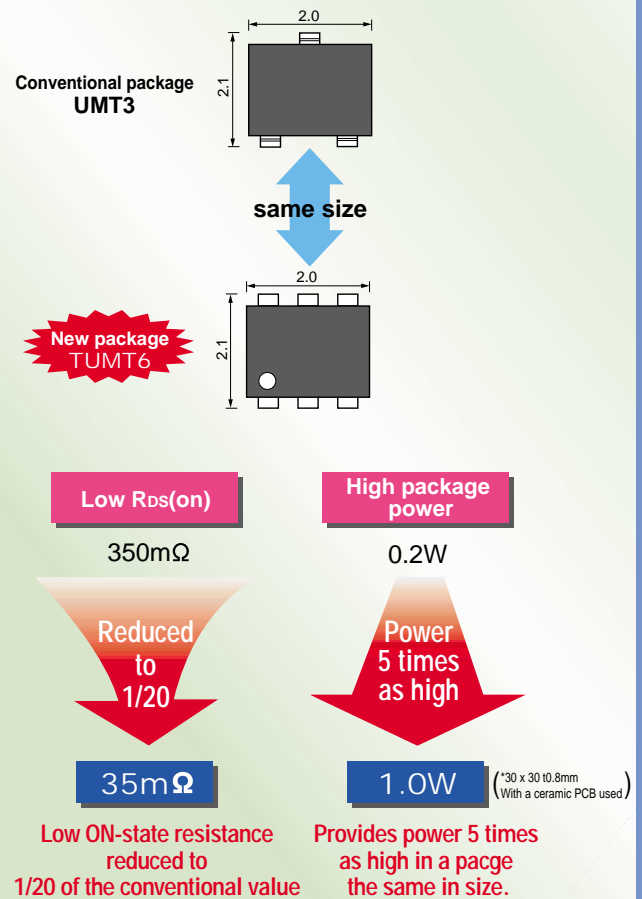

TUMT•TSMT Series

Drive Voltage:4V Note) Internal circuit:P.9

Nch

Package	Part No.	Type	V _{bss} (V)	I _b (A)	R _{ds(on)} (mΩ) ^{*1}		Q _g ^{*2} (nC)	Circuit
					Typ.	Max.		
TUMT3	RSF014N03	Single	30	1.4	170	230	1.4	Fig. 2
TUMT6	US6K2	Dual						Fig. 5
TSMT6	RSQ035N03	Single		3.5	44	62	5.3	Fig. 1
	RSQ045N03			4.5	27	38	6.8	

*1:V_{GS}=10V *2:V_{GS}=5V

Pch

Package	Part No.	Type	V _{bss} (V)	I _b (A)	R _{ds(on)} (mΩ) ^{*1}		Q _g ^{*2} (nC)	Circuit
					Typ.	Max.		
TUMT3	RSF010P03	Single	30	1	260	350	1.9	Fig.10
TSMT3	RSR015P03			1.5	170	235	2.6	
	RSR020P03			2	85	120	4.3	
	RSR025P03			2.5	70	98	5.4	
TSMT6	RSQ025P03				80	110	4.9	
	RSQ030P03			3	60	80	6	Fig. 9
	RSQ035P03	3.5	45	65	9			

*1:V_{GS}=10V *2:V_{GS}=5V

Nch+SBD

Package	Part No.	Type	V _{bss} (V) V _R (V)	I _b (A) I _o (A)	R _{ds(on)} (mΩ) / V _F (V)		Q _g (nC)	Circuit
					Typ.	Max.		
TUMT5	US5U1	MOS	30	1.5	170	240	1.6	Fig. 8
		SBD	20	0.5	—	0.36	—	
	US5U2	MOS	30	1.4	170	240	1.4	
		SBD	20	0.5	—	0.36	—	

Pch+SBD

Package	Part No.	Type	V _{bss} (V) V _R (V)	I _b (A) I _o (A)	R _{ds(on)} (mΩ) / V _F (V)		Q _g (nC)	Circuit
					Typ.	Max.		
TSMT6	QS6U24	MOS	30	1	300	400	1.7	Fig. 15
		SBD	20	0.7	—	0.49	—	

Pch+Nch

Package	Part No.	Type	V _{bss} (V)	I _b (A)	R _{ds(on)} (mΩ) ^{*1}		Q _g ^{*2} (nC)	Circuit
					Typ.	Max.		
TUMT6	US6M1	Nch	30	1.4	170	240	1.4	Fig. 16
		Pch	20	1	280	390	2.1	

*1:V_{GS}=10V *2:V_{GS}=5V

MOS FET

TUMT•TSMT Series

Drive Voltage: 2.5V Note) Internal circuit: P.9

Nch

Package	Part No.	Type	V _{DSS} (V)	I _D (A)	R _{DS(on)} (mΩ) *1		Q _g *2 (nC)	Circuit
					Typ.	Max.		
TUMT3	RTF015N03	Single	30	1.5	170	240	1.6	Fig. 2
	RTF025N03			2.5	48	67	3.7	
TUMT6	RTL035N03	3.5		35	56	4.6	Fig. 1	
TUMT5	US5K3	Dual		1.5	170	240	1.6	Fig. 4
TUMT6	US6K1			Fig. 5				
TSMT3	RTR025N03	Single		2.5	66	92	3.3	Fig. 2
	RTR040N03			4	34	48	5.9	
TSMT6	RTQ020N03	Single		2	89	125	2.4	Fig. 1
	RTQ035N03			3.5	38	54	5	
	RTQ045N03			4.5	30	43	7.6	
TSMT5	QS6K1	Dual	1	170	238	1.7	Fig. 3	
	QS5K2			71	100	2.8	Fig. 4	

*1:V_{GS}=4.5V *2:V_{GS}=4.5V

Pch

Package	Part No.	Type	V _{DSS} (V)	I _D (A)	R _{DS(on)} (mΩ) *1		Q _g *2 (nC)	Circuit
					Typ.	Max.		
TUMT3	RTF010P02	Single	20	1	280	390	2.1	Fig. 10
	RTF011P02			1.1			2	
	RTF015P02			1.5	100	135	5.2	
	RTF020P02			2	60	85	7	
TUMT6	RTL020P02	Single		2	100	135	4.9	Fig. 9
	RTL030P02			3	50	70	8	
	US6J2			Dual	1	280	390	
TSMT3	RTR020P02	Single		2	100	135	4.9	Fig. 10
	RTR025P02			2.5	70	95	7	
	RTR030P02			3	55	75	9.3	
TSMT6	RTQ025P02	Single	2.5	72	100	7.0	Fig. 9	
	RTQ030P02		3	60	80	9.3		
	RTQ035P02		3.5	50	65	10.5		
	RTQ040P02		4	35	50	12.5		
	QS6J1	Dual	1.5	155	215	3	Fig. 11	
QS6J3	Fig. 12							

*1:V_{GS}=4.5V *2:V_{GS}=4.5V

Nch+SBD

Package	Part No.	Type	V _{DSS} (V) V _R (V)	I _D (A) I _O (A)	R _{DS(on)} (mΩ) / V _F (V) *1		Q _g *2 (nC)	Circuit
					Typ.	Max.		
TUMT5	US5U3	MOS	30	1.5	170	240	1.6	Fig. 8
		SBD	20	0.7	—	0.49	—	
TSMT5	QS5U12	MOS	30	2	71	100	2.8	Fig. 7
		SBD	20	1	—	0.45	—	
	QS5U13	MOS	30	2	71	100	2.8	Fig. 8
		SBD	20	0.5	—	0.36	—	
	QS5U16	MOS	30	2	71	100	2.8	
		SBD	20	0.5	—	0.36	—	
QS5U17	MOS	30	2	71	100	2.8		
	SBD	20	1	—	0.45	—		

*1:V_{GS}=4.5V *2:V_{GS}=4.5V

TUMT•TSMT Series

Drive Voltage:2.5V Note) Internal circuit:P.9

Pch+SBD

Package	Part No.	Type	V _{DSS} (V) V _R (V)	I _b (A) I _o (A)	R _{DS(on)} (mΩ) / V _F (V) *1		Q _g *2 (nC)	Circuit	
					Typ.	Max.			
TUMT5	US5U29	MOS	20	1	280	390	2.1	Fig. 14	
		SBD		0.7	—	0.49	—		
	US5U30	MOS		1	280	390	2.1		
		SBD		0.5	—	0.36	—		
TSMT5	QS5U21	MOS		1.5	160	200	4.5	Fig. 13	
		SBD		1	—	0.45	—		
	QS5U23	MOS		1.5	160	200	4.5		
		SBD		0.5	—	0.36	—		
	QS5U26	MOS		1.5	160	200	4.5	Fig. 14	
		SBD		0.5	—	0.45	—		
		QS5U27		MOS	1.5	160	200		4.5
				SBD	1	—	0.45		—
	QS5U28	MOS	2	90	125	5			
		SBD	1	—	0.45	—			
TSMT6	QS6U22	MOS	1.5	155	215	3	Fig. 15		
		SBD	0.7	—	0.49	—			

*1:V_{GS}=4.5V *2:V_{GS}=4.5V

Pch+Nch

Package	Part No.	Type	V _{DSS} (V)	I _b (A)	R _{DS(on)} (mΩ) *1		Q _g *2 (nC)	Circuit
					Typ.	Max.		
TUMT6	US6M2	Nch	30	1.5	170	240	1.6	Fig. 16
		Pch	20	1	280	390	2.1	
TSMT6	QS6M3	Nch	30	1.5	170	230	1.7	Fig. 17
		Pch	20		155	215	3	
	QS6M4	Nch	30		170	230	1.7	Fig. 16
		Pch	20		155	215	3	

*1:V_{GS}=4.5V *2:V_{GS}=4.5V

MOS FET

SOP8

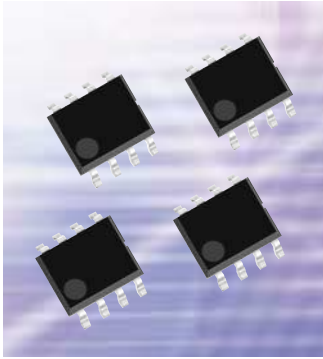

Features

- Low $R_{ds(on)}$** Low power consumption
- Low Q_g** Fast switching speed
- High ESD capability** Failure reduction
- Dense mounting** Two elements in one package



Ideal for DC/DC converter and power management SW.
Meets the key needs of MOSFET in power supply DC/DC converter.

Example of application circuit

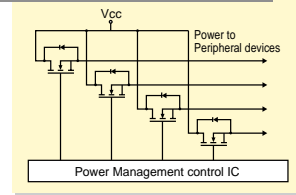

Power Management Circuit

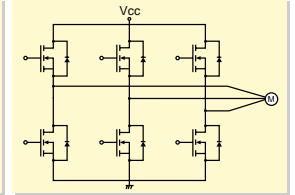

Motor Drive Circuit

Drive Voltage:4V

Note) Internal circuit:P.10

Nch

Package	Part No.	Type	V_{DSS} (V)	I_D (A)	$R_{ds(on)}$ (m Ω) ^{*1}		Q_g (nC) ^{*2}	Circuit
					Typ.	Max.		
SOP8	RSS065N03	Single	30	6.5	19	27	6.1	Fig. 18
	RSS090N03			9	11	16	11	
	RSS100N03			10	9.5	13.3	14	
	RSS105N03			10.5	8.5	11.9	15	
	RSS110N03			11	7.6	10.7	17	
	RSS120N03			12	7.1	10	18	
	RSS125N03			12.5	6.5	9.1	20	
	RSS130N03			13	5.9	8.3	25	
	RSS140N03			14	4.9	6.9	37	
	SP8K5	Dual		3.5	59	83	2.5	Fig. 19
	SP8K1			5	36	51	3.9	
	SP8K2			6	21	30	7.2	
	SP8K3			7	17	24	8.4	
	SP8K4			9	12	17	15	

*1: $V_{GS}=10V$ *2: $V_{GS}=5V$

Pch

Package	Part No.	Type	V_{DSS} (V)	I_D (A)	$R_{ds(on)}$ (m Ω) ^{*1}		Q_g (nC) ^{*2}	Circuit
					Typ.	Max.		
SOP8	RSS040P03	Single	30	4	42	58	8.0	Fig. 20
	RSS050P03			5	30	42	13	
	RSS075P03			7.5	15	21	30	
	RSS090P03			9	10	14	39	
	SP8J4	Dual		2	170	235	2.4	Fig. 21
	SP8J3			3.5	65	90	5.5	
	SP8J2			4.5	40	56	8.5	
	SP8J1			5	30	42	16	
	SP8J5			7	20	28	25	

*1: $V_{GS}=10V$ *2: $V_{GS}=5V$

Other Packages

Drive Voltage:2.5V Note) Internal circuit:P.9

Nch

Package	Part No.	Type	V _{DSS} (V)	I _D (A)	R _{DS(on)} (Ω) *3		Circuit
					Typ.	Max.	
VMT3	2SK3541	Single	30	0.1	5	8	Fig. 2
EMT3	2SK3019						
UMT3	2SK3018						
	RJU003N03						
SMT3	RJK005N03						
MPT3	2SK3065	60	2	0.25	0.32	Fig. 6	
	RJP020N06						
EMT6	EM6K1	Dual	30	0.1	5	8	Fig. 5
UMT6	UM6K1N						
SMT6	SM6K4						

*3:V_{GS}=4V

Pch

Package	Part No.	Type	V _{DSS} (V)	I _D (A)	R _{DS(on)} (Ω) *3		Circuit
					Typ.	Max.	
VMT3	RTM002P02	Single	30	0.2	1.1	1.6	Fig. 2
EMT3	RTE002P02						
UMT3	RTU002P02						

*3:V_{GS}=4V

Drive Voltage:4V Note) Internal circuit:P.9

Nch

Package	Part No.	Type	V _{DSS} (V)	I _D (A)	R _{DS(on)} (Ω) *1		Circuit
					Typ.	Max.	
UMT3	RHU003N03	Single	30	0.3	0.75	1.2	Fig. 2
	RHU002N06						
SST3	RK7002		60	0.115	2.2	7.5	
	RK7002A						
SMT3	RHK005N03		30	0.5	0.34	0.55	
	RHK002N06		60	0.2	1.7	—	
	RHK003N06						
MPT3	RHP030N03	30	0.3	0.09	0.12	Fig. 6	
	RHP020N06	60	0.2	0.15	0.20		
SMT6	SM6K2	Dual	60	0.2	1.6	—	Fig. 5

*1:V_{GS}=10V

Pch

Package	Part No.	Type	V _{DSS} (V)	I _D (A)	R _{DS(on)} (Ω) *1		Circuit
					Typ.	Max.	
VMT3	RSM002P03	Single	30	0.2	0.9	1.4	Fig. 2
EMT3	RSE002P03						
UMT3	RSU002P03						

*1:V_{GS}=10V

MOS FET

PSOP8·PSOP8S

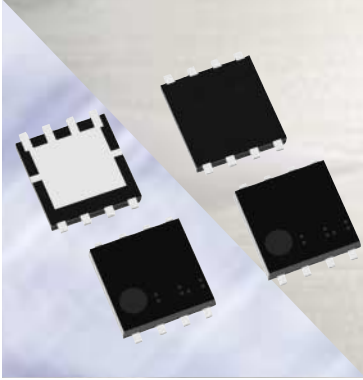

Features 1

- Realizes great power supply efficiency with our new technology (i.e., a 8% increase compared to conventional models) → Ideal for CPU cores
- Incorporates a high-speed optimized switch on the high side and a low ON resistance on the low side

Power Supply Efficiency Evaluation

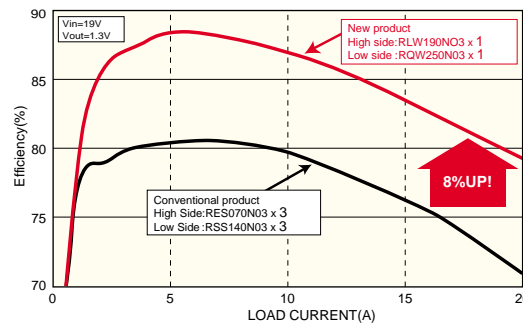

DC-DC converter(CPU Core)Circuit Diagram

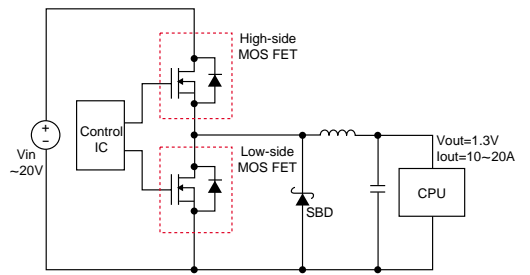

Features 2

- Single PSOP8 package replacing two SOP8 packages

The single PSOP8 package has excellent heat dissipation (with a PD 1.5 times as high as that of SOP8 packages), that allows the replacement of conventional two SOP8 packages in parallel connection

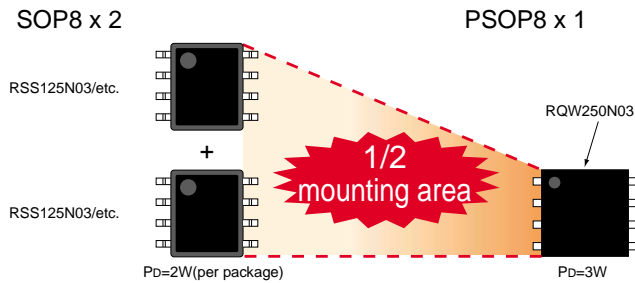

Nch Note) Internal circuit:P.10

● For Low Side

Package	Part No.	Type	V _{bss} (V)	I _d (A)	R _{ds(on)} (mΩ) ^{*1}		Q _{gd} ^{*2} (nC)	Circuit
					Typ.	Max.		
PSOP8	RQW160N03	Single	30	16	5.5	7.7	4.1	Fig. 18
	RQW180N03			18	4.1	5.4	5.4	
	RQW200N03			20	3.0	3.9	7.5	
	RQW250N03			25	1.8	2.5	11.2	
PSOP8S	RQA160N03	Single	30	16	5.5	7.7	4.1	
	RQA180N03			18	4.1	5.4	5.4	
	RQA200N03			20	3.0	3.9	7.5	

*1:V_{gs}=10V *2:V_{gs}=5V

● For High Side

Package	Part No.	Type	V _{bss} (V)	I _d (A)	R _{ds(on)} (mΩ) ^{*1}		Q _{gd} ^{*2} (nC)	Circuit
					Typ.	Max.		
PSOP8	RLW130N03	Single	30	13	9.5	13.3	3.4	Fig. 18
	RLW140N03			14	8.7	12.2	3.6	
	RLW190N03			19	4.4	6.2	6.8	
PSOP8S	RLA130N03	Single	30	13	9.5	13.3	3.4	
	RLA140N03			14	8.7	12.2	3.6	

*1:V_{gs}=10V *2:V_{gs}=5V

Power Transistors

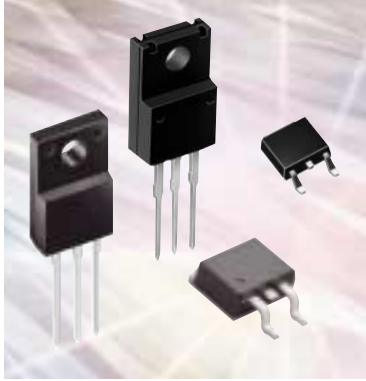

Features

- Realizes low $R_{DS(on)}$ by optimized design pattern.
- Built-in gate protection diode
- Avalanche capability ratings

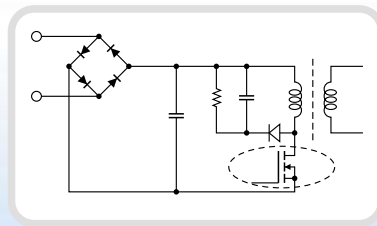

Application

- PDP, Power Supply

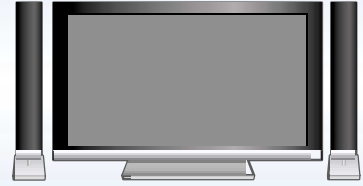

Nch

Package	Part No.	V_{DSS} (V)	I_b (A)	$R_{DS(on)}$ (Ω) *1	
				Typ.	Max.
CPT3	2SK2887	200	3	0.7	0.9
	RDD050N20		5	0.55	0.72
	2SK2715	500	2	3	4
	2SK3050	600	2	4.4	5.5
D2PAK	RDJ150N20	200	15	0.12	0.16
	RDJ080N25	250	8	0.38	0.5
	RDJ120N25		12	0.16	0.21
TO-220FN	RDN050N20	200	5	0.55	0.72
	RDN100N20		10	0.27	0.36
	RDN150N20	250	15	0.12	0.16
	RDN080N25		8	0.38	0.5
	RDN120N25		12	0.16	0.21
TO-220FM	RDX300N15	150	30	0.032	0.044
	RDX280N20	200	28	0.048	0.062
	RDX250N23	230	25	0.06	0.076
	RDX220N25	250	22	0.075	0.097
	RDX080N40	400	8	0.6	0.8
	RDX120N40		12	0.35	0.46
	RDX060N45	450	6	0.65	0.92
	RDX100N45		10	0.4	0.55
	RDX050N50	500	5	1.1	1.5
	RDX080N50		8	0.7	0.85
	RDX120N50		12	0.4	0.52
	RDX045N60	600	4.5	1.6	2.1
	RDX060N60		6	0.9	1.25
RDX100N60	10		0.55	0.75	

*1: $V_{GS}=10V$

MOS FET

Internal Circuit

TSMT / TUMT / VMT / EMT / UMT / SMT / MPT

Note) About more detail information, please see the latest technical specifications.

Nch

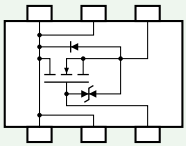

Fig.1

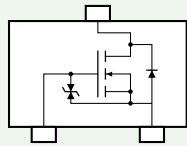

Fig.2

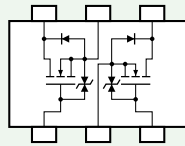

Fig.3

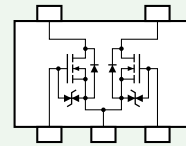

Fig.4

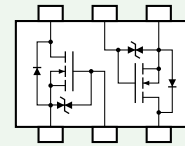

Fig.5

Nch(MPT3)

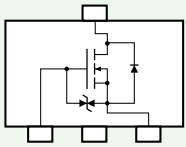

Fig.6

Nch+SBD

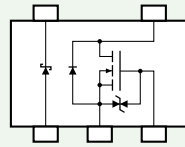

Fig.7

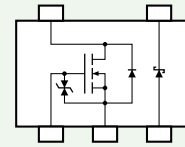

Fig.8

Pch

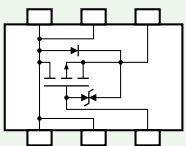

Fig.9

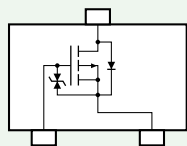

Fig.10

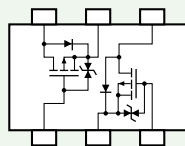

Fig.11

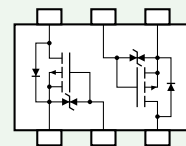

Fig.12

Pch+SBD

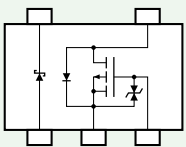

Fig.13

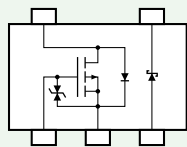

Fig.14

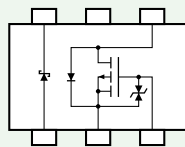

Fig.15

Nch+Pch

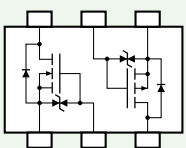

Fig.16

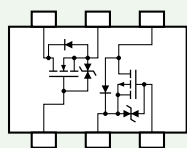
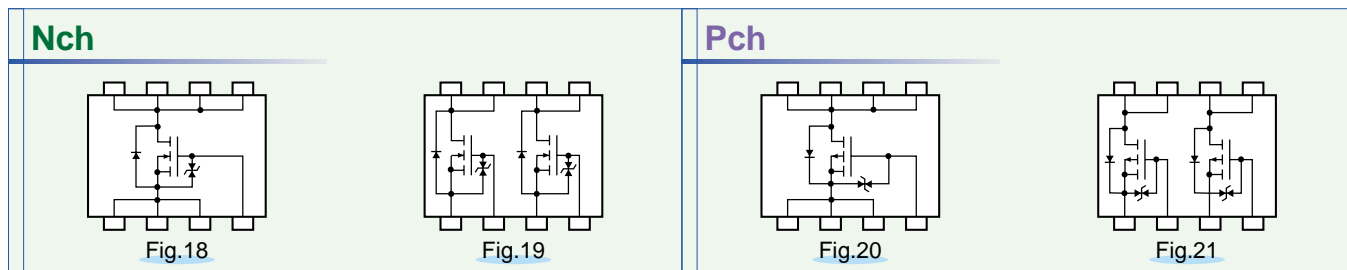

Fig.17

SOP8 / PSOP8 / PSOP8S

Note) About more detail information, please see the latest technical specifications.



Low $V_{CE(sat)}$ Miniature Digital Transistors

Single Type

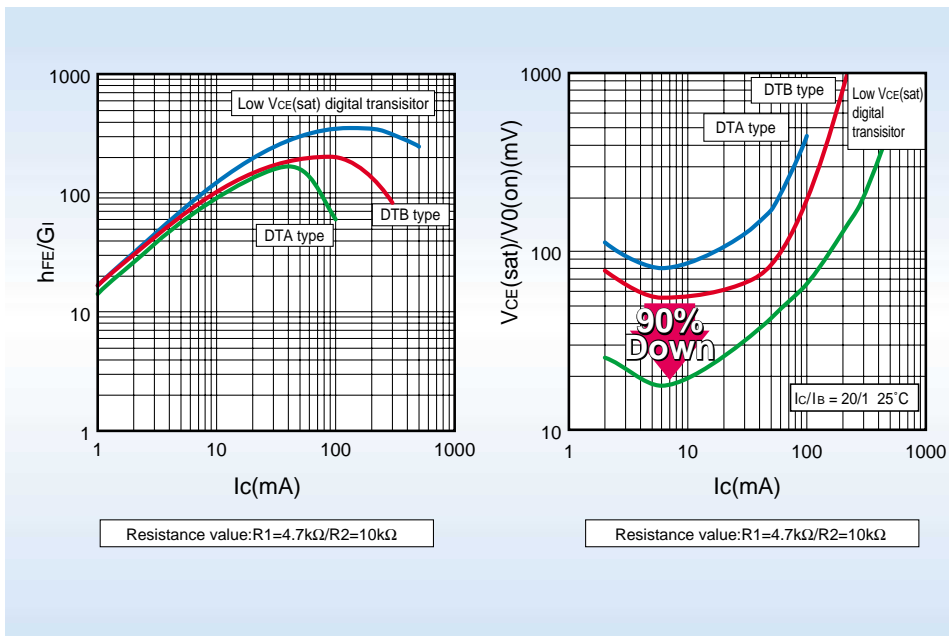

V_{CC} (V)	I_c (mA)	PNP	NPN	Built-in resistors		Package		G_i	$V_{O(on)}$ Typ.(mV)
				R1 (kΩ)	R2 (kΩ)	VMT3 	EMT3 		
12	500	DTB513Z	DTD513Z	1	10	●	●	140~	70
		DTB523Y	DTD523Y	2.2	10	●	●	140~	
		DTB543E	DTD543E	4.7	4.7	●	●	120~	
		DTB543X	DTD543X	4.7	10	●	●	140~	
		DTB543Z	DTD543Z	4.7	47	●	●	150~	
30	200	DTB713Z	DTD713Z	1	10	●	●	140~	
		DTB723Y	DTD723Y	2.2	10	●	●	140~	
		DTB743E	DTD743E	4.7	4.7	●	●	120~	
		DTB743X	DTD743X	4.7	10	●	●	140~	
		DTB743Z	DTD743Z	4.7	47	●	●	150~	

Complex Type

For switing of compact portable devices.

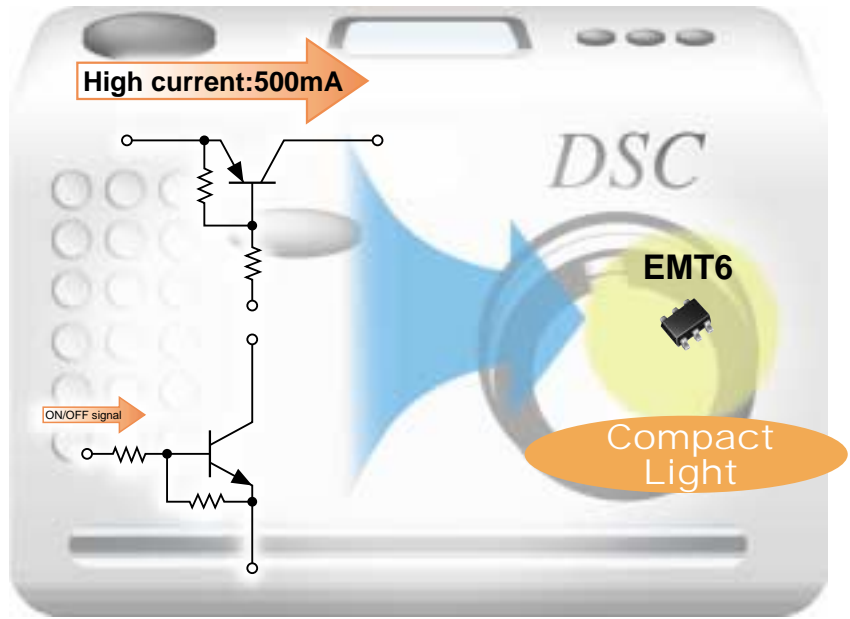
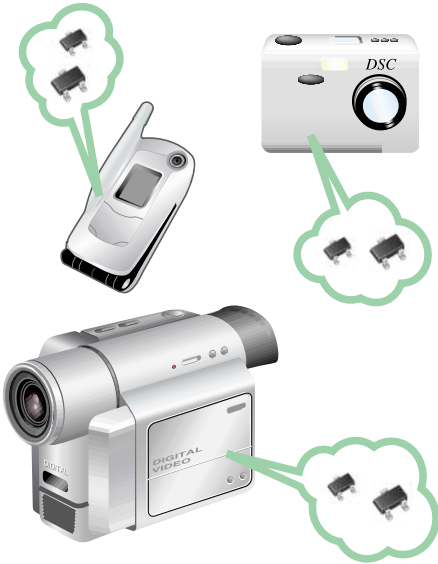

Ultra-miniature package:EMT6(1612 size)

Low $V_{CE(sat)}$ digital transistor and small signal digital transistor in one package.

Ideal for switching in power management circuit.

Circuit	Part No.	Elements	$V_{CC}(V)$	$I_o(mA)$	h_{FE}	$R_1(k\Omega)$	$R_2(k\Omega)$
	EMD28	DTR1 DTB543XM <small>Low $V_{CE(sat)}$ Digital Transistor</small>	-12	-500	140~	4.7	10
		DTR2 DTC144EM	50	30	68~	47	47
	EMD29	DTR1 DTB513ZM <small>Low $V_{CE(sat)}$ Digital Transistor</small>	-12	-500	140~	1	10
		DTR2 DTC114EM	50	50	30~	10	10
	EMD30	DTR1 DTB713ZM <small>Low $V_{CE(sat)}$ Digital Transistor</small>	-30	-200	140~	1	10
		DTR2 DTC114EM	50	50	30~	10	10
	EMF33	DTR1 DTB513ZM <small>Low $V_{CE(sat)}$ Digital Transistor</small>	-12	-500	140~	1	10
		MOS FET 2SK3019	30	0.1	Drive Voltage:2.5V		

Low $V_{CE(sat)}$ Transistor Series

ROHM development has achieved a Low $V_{CE(sat)}$ Transistor series in various small surface mount packages. These Low $V_{CE(sat)}$ Transistors are suitable for digital equipment.

Features

- Low $V_{CE(sat)}$ Transistors in small surface mount packages!
- Low Energy Consumption.
- High Collector Current.

Application

- Switching circuits
- DC/DC converters





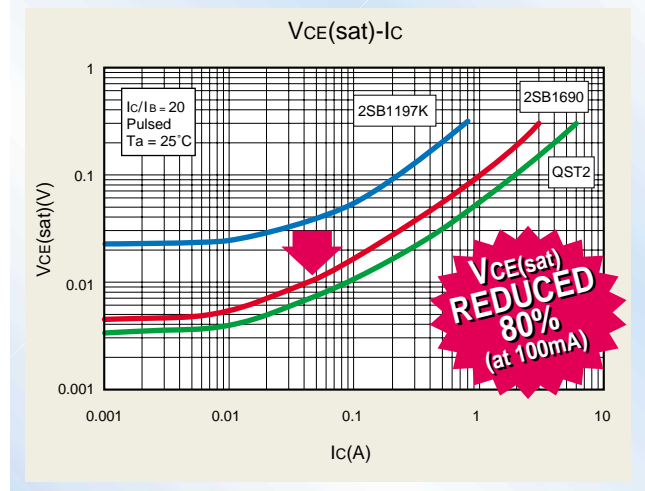
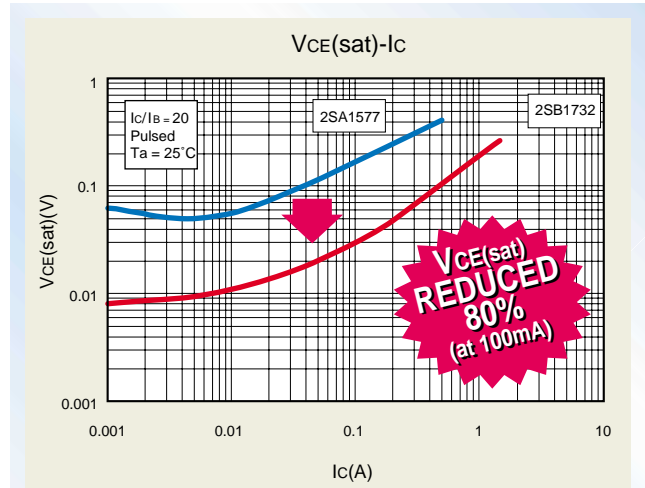



For Portable Equipment:
(i.e. Mobile phone, MD, CD-ROM,
DVD-ROM, Notebook PC, etc.)



● Single Type

VMT3		EMT3		UMT3		TUMT3		TUMT6		TSMT3		TSMT6		V_{CE0} (V)	I_c (A)
PNP	NPN	PNP	NPN	PNP	NPN	PNP	NPN	PNP	NPN	PNP	NPN	PNP	NPN		
2SA2030	2SC5663	2SA2018	2SC5585											12	0.5
				2SB1689	2SD2652	2SB1732	25D2702			2SB1709	2SD2674			12	1.5
						2SB1730	25D2700	US6T6	US6X5	2SB1690	2SD2653	QST6	QSX5	12	2
								US6T4	US6X3	2SB1705	2SD2670	QST4	QSX3	12	3
										2SB1707	2SD2672			12	4
												QST2	QSX1	12	6
				2SB1694	2SD2656	2SB1733	25D2703			2SB1710	2SD2675			30	1
						2SB1731	25D2701	US6T7	US6X6	2SB1695	2SD2657	QST7	QSX6	30	1.5
								US6T5	US6X4	2SB1706	2SD2671	QST5	QSX4	30	2
										2SB1708	2SD2673			30	3
												QST3	QSX2	30	5

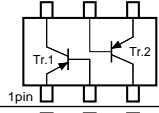
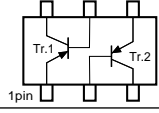
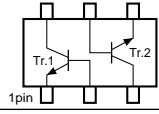
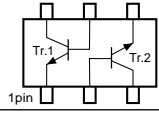
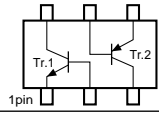
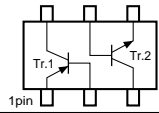
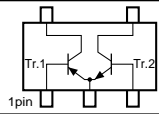
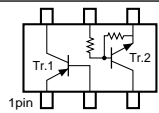
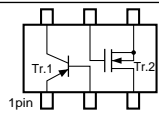
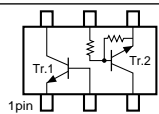
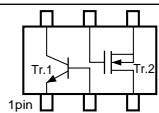
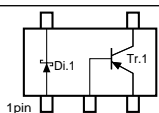
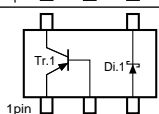
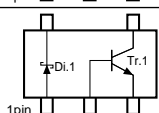
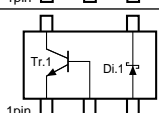
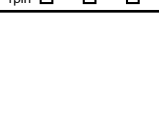
● Complex Type

Type	Circuit	EMT6	UMT5/UMT6	TUMT5/TUMT6	TSMT5/TSMT6	Combination	V _{CEO} (V)	I _c (A)
								
PNP x2		EMT18	UMT18N			2SA2018 2SA2018	12	0.5
				US6T8	QST8	2SB1709 2SB1709	12	1.5
				US6T9	QST9	2SB1710 2SB1710	30	1
NPN x2		EMX18	UMX18N			2SC5585 2SC5585	12	0.5
				US6X7	QSX7	2SD2674 2SD2674	12	1.5
				US6X8	QSX8	2SD2675 2SD2675	30	1
PNP + NPN		EMZ7	UMZ7N			2SA2018 2SC5585	12	0.5
		EMZ8	UMZ8N			2SA2018 2SC4617	12 50	0.5 0.15
					QSZ1	2SB1690 2SD2653	12	2
					QSZ2	2SB1695 2SD2657	30	1.5
PNP + DTr		EMF4	UMF4N			2SA2018 DTC123E	12 50	0.5 0.1
		EMF5	UMF5N			2SA2018 DTC144E	12 50	0.5 0.1
		EMF21	UMF21N			2SA2018 DTC114E	12 50	0.5 0.1
PNP + MOS		EMF6	UMF6N			2SA2018 2SK3019	12 30	0.5 0.1
NPN + DTr		EMF7	UMF7N			2SC5585 DTC123E	12 50	0.5 0.1
		EMF8	UMF8N			2SC5585 DTC144E	12 50	0.5 0.1
		EMF22	UMF22N			2SC5585 DTC114E	12 50	0.5 0.1
NPN + MOS		EMF9	UMF9N			2SC5585 2SK3019	12 30	0.5 0.1
PNP + SBD			UML4N			2SA2018 RB521S-30	12 30	0.5 0.2
				US5L9	QSL9	2SB1707 RB461F	12 20	1.5 0.7
				US5L11	QSL11	2SB1708 RB461F	30 20	1 0.7
NPN + SBD				US5L10	QSL10	2SB1690 RB400D	12 40	2 0.5
			UML6N			2SC5585 RB521S-30	12 30	0.5 0.2
				US5L12	QSL12	2SD2672 RB461F	12 20	1.5 0.7
				US5L12	QSL12	2SD2673 RB461F	30 20	1 0.7

Endured Discharge Voltage/ High Speed Switching/Low Noise Transistor Series

Outline

Introducing our new technology, we realized both high power durability and high speed switching in small surface mount packages.

Features







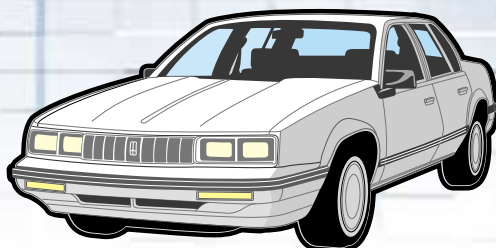
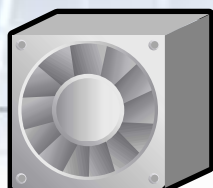
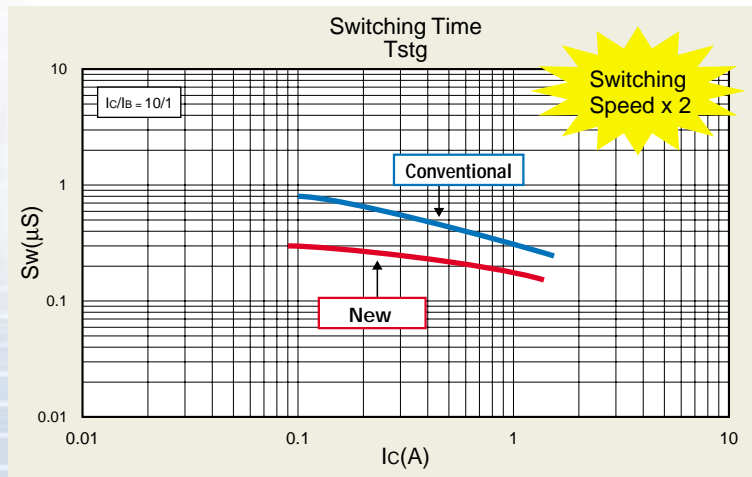
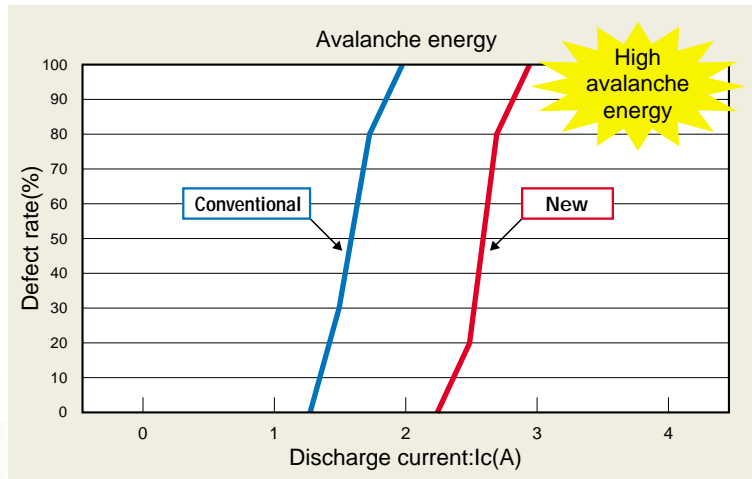
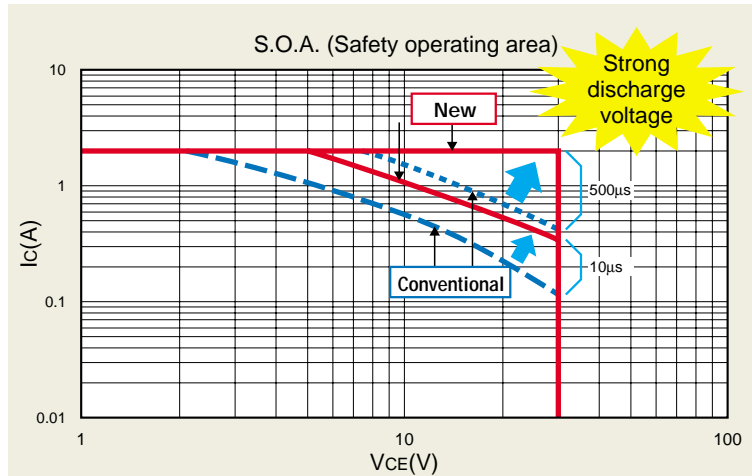











- High electrical power durability (wide S.O.A.) 5 times better
- High speed switching 2 times faster
- High avalanche energy 4 times better

Applications



- DC/DC converter
- Motor drive



Series Line-up

Surface mount devices	Current (A)	Package	Voltage [V]		
			30	60	90
	0.5	UMT3 	2SA2047/2SC5729	2SA2088/2SC5876	
TUMT3 			2SA2137/2SC5887	2SA2139/2SC5989	
SMT3 				2SA2054K/2SC5734K	
TSMT3 			2SA2090/2SC5868	2SA2054/2SC5734	
1	TUMT3 	2SA2136/2SC5986	2SA2138/2SC5988		
	TUMT6 			2SA2133/2SC5983	
	TSMT3 	2SA2048/2SC5730	2SA2092/2SC5865	2SC5734/2SC5917	
	MPT3 	2SA2155/2SC6027		2SA2051/2SC5733	
2	TUMT6 	2SA2131/2SC5981	2SA2132/2SC5982		
	TSMT3 	2SA2113/2SC5916	2SA2094/2SC5866	2SA2135/2SC5985	
	MPT3 	2SA2049/2SC5731		2SA2109/2SC5918	
	CPT3 	2SA2156/2SC6029		2SA2108/2SC5919	
3	TSMT3 		2SA2095/2SC5867	2SA2135/2SC5985	
	MPT3 		2SA2071/2SC5824		
	CPT3 		2SA2072/2SC5825		
5	TSMT3 	2SA2134/2SC5984*			
	MPT3 	2SA2157/2SC6028			
	CPT3 	2SA2050/2SC5732	2SA2096/2SC5881		
10	CPT3 	2SA2143/2SC6002	2SA2147/2SC6006		

*V_{CEO}=45V



Through-hole devices	Current (A)	Package	Voltage [V]		
			30	60	90
	0.5	SPT 	2SA2085S/2SC5873S	2SA2089S/2SC5877S	2SA2115S/2SC5920S
2SA2086S/2SC5874S			2SA2091S/2SC5879S	2SA2106S/2SC5921S	
1	ATV 			2SA2110/2SC5922	
2		2SA2087/2SC5875	2SA2093/2SC5880	2SA2107/2SC5923	
3	TO220FN 		2SA2073/2SC5826		
			2SA2160/2SC6007		
10			2SA2149/2SC6005		

Endured Discharge Voltage/ High Speed Switching Transistor Series

Characteristics

● Surface mount devices

Package	Part No.		BV _{CEO} [V]	I _c [A]	I _{CP} [A]	hFE	RANK	SW time [ns]		
	PNP	NPN						ton	tstg	tf
UMT3 P _C =0.2W 	2SA2047	2SC5729	30	0.5	1	120~390	Q,R	40/40	100/120	40/50
	2SA2088	2SC5876	60					120~270 /120~390	Q/Q,R	40/70

Package	Part No.		BV _{CEO} [V]	I _c [A]	I _{CP} [A]	hFE	RANK	SW time [ns]				
	PNP	NPN						ton	tstg	tf		
TUMT3 P _C =0.5W 	2SA2136	2SC5986	30	1	2	120~390	Q,R	30/30	100/120	20/35		
	2SA2137	2SC5987	60	0.5	1			120~270 /120~390	Q/Q,R	35/70	100/130	20/80
	2SA2138	2SC5988		1	2					30/50	100/130	30/50
	2SA2139	2SC5889	90	0.5	1					35/50	160/200	60/80
TUMT6 P _C =0.5W 	2SA2131	2SC5981	30	2	4	120~270 /120~390	Q/Q,R			25/25	100/100	20/20
	2SA2132	2SC5982	60	2	4			25/30	100/120	30/35		
	2SA2133	2SC5983	90	1	2			30/50	150/150	50/50		

Package	Part No.		BV _{CEO} [V]	I _c [A]	I _{CP} [A]	hFE	RANK	SW time [ns]		
	PNP	NPN						ton	tstg	tf
SMT3 P _C =0.2W 	2SA2048K	2SC5730K	30	1	2	120~390	Q,R	30/30	100/120	20/35
	2SA2054K	2SC5734K	90	0.5	1			120~270 /120~390	Q/Q,R	35/30

Package	Part No.		BV _{CEO} [V]	I _c [A]	I _{CP} [A]	hFE	RANK	SW time [ns]		
	PNP	NPN						ton	tstg	tf
TSMT3 P _C =0.5W 	2SA2048	2SC5730	30	1	2	120~390	Q,R	30/30	100/120	20/35
	2SA2113	2SC5916		2	4			25/25	100/100	20/20
	2SA2134	2SC5984*		5	10			30/60	100/130	50/20
	2SA2090	2SC5868	60	0.5	1	120~270 /120~390	Q/Q,R	70/70	130/130	80/80
	2SA2092	2SC5865		1	2			30/50	100/130	30/50
	2SA2094	2SC5866		2	4			25/50	100/120	30/35
	2SA2095	2SC5867		3	6			20/50	150/150	20/60
	2SA2054	2SC5734	90	0.5	1	120~270 /120~390	Q/Q,R	35/50	160/200	60/80
	2SA2114	2SC5917		1	2			30/50	150/150	50/50
	2SA2135	2SC5985		2	4			30/50	280/300	50/80

*45V

Package	Part No.		BV _{CEO} [V]	I _c [A]	I _{CP} [A]	hFE	RANK	SW time [ns]		
	PNP	NPN						ton	tstg	tf
MPT3 P _C =0.5W 	2SA2155	2SC6027	30	1	2	120~390	Q,R	30/30	100/120	20/35
	2SA2049	2SC5731		2	4			20/25	120/100	20/20
	2SA2157	2SC6028		5	7			25/50	110/130	20/25
	2SA2071	2SC5824	60	3	6	120~270 /120~390	Q/Q,R	20/50	130/150	20/30
	2SA2051	2SC5733	90	1	2			30/50	150/150	50/50
	2SA2109	2SC5918		2	4			25/50	280/300	50/80

Package	Part No.		BV _{CEO} [V]	I _C [A]	I _{CP} [A]	h _{FE}	RANK	SW time [ns]		
	PNP	NPN						ton	tstg	tf
CPT3 P _c =1W 	2SA2156	2SC6029	30	2	4	120~390	Q,R	20/25	120/100	20/20
	2SA2050	2SC5732		5	10			25/60	100/130	20/25
	2SA2143	2SC6002		10	15			30/30	130/150	30/40
	2SA2072	2SC5825	60	3	6	120~270 /120~390	Q/Q,R	20/50	130/150	20/30
	2SA2096	2SC5881		5	10			25/70	130/150	25/25
	2SA2147	2SC6006		10	15			25/60	120/150	20/40
	2SA2108	2SC5919	90	2	4			70/70	200/200	70/70

● Through-hole devices

Package	Part No.		BV _{CEO} [V]	I _C [A]	I _{CP} [A]	h _{FE}	RANK	SW time [ns]		
	PNP	NPN						ton	tstg	tf
SPT P _c =0.3W 	2SA2085S	2SC5873S	30	0.5	1	120~390	Q,R	40/40	100/120	40/50
	2SA2086S	2SC5874S		1	2			30/30	100/120	20/35
	2SA2089S	2SC5877S	60	0.5	1	120~270 /120~390	Q/Q,R	70/35	130/100	80/60
	2SA2091S	2SC5879S		1	2			30/50	100/130	30/50
	2SA2115S	2SC5920S	90	0.5	1			50/50	200/200	80/80
	2SA2106S	2SC5921S		1	2	30/50	150/150	50/50		

Package	Part No.		BV _{CEO} [V]	I _C [A]	I _{CP} [A]	h _{FE}	RANK	SW time [ns]		
	PNP	NPN						ton	tstg	tf
ATV P _c =1W 	2SA2087	2SC5875	30	2	4	120~390	Q,R	25/25	100/100	20/20
	2SA2093	2SC5880	60							
	2SA2073	2SC5826		3	6	120~270 /120~390	Q/Q,R	20/50	130/150	20/30
	2SA2110	2SC5922		1	2			30/50	150/150	50/50
	2SA2107	2SC5923	90	2	4			25/50	280/300	50/80

Package	Part No.		BV _{CEO} [V]	I _C [A]	I _{CP} [A]	h _{FE}	RANK	SW time [ns]		
	PNP	NPN						ton	tstg	tf
TO220FN P _c =2W 	2SA2160	2SC6007	60	3	6	120~270 /120~390	Q/Q,R	50/50	130/150	50/30
	2SA2149	2SC6005	60	10	15			30/25	130/150	50/30

Note) About more detail information, please see the latest technical specifications.

Muting Transistors

High- β & High-BVEBO

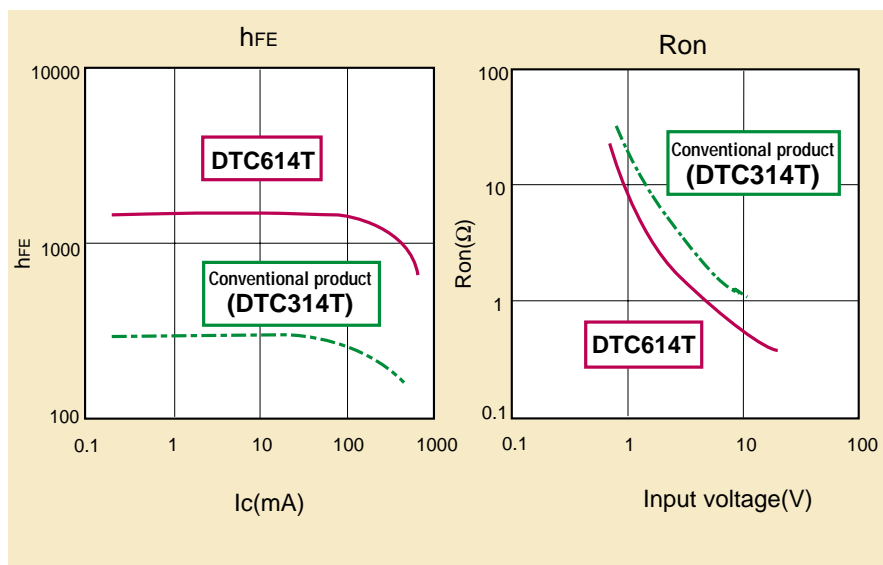
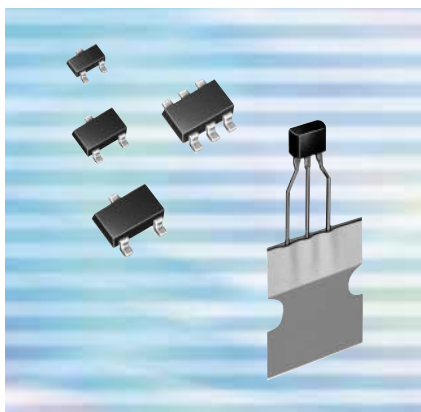

Built-in Resistor type

Part No.	R1/R2(kΩ)	Internal circuit	UMT3	SMT3	SPT	BVEBO(V)	BVCEO(V)	Ic(mA)	Ron(Ω)
DTC623T	2.2/—		●	●	●	12	20	600	0.4
DTC643T	4.7/—		●	●	●				0.55
DTC663E	6.8/6.8		●	●	—				0.9
DTC614T	10/—		●	●	●				0.9

Part No.	R1/R2(kΩ)	Internal circuit	Elements	SMT6	BVEBO(V)	BVCEO(V)	Ic(mA)	Ron(Ω)
IMH24	2.2/—		DTC623T	●	12	20	600	0.4
IMH23	4.7/—		DTC643T	●				0.55
IMH22	6.8/6.8		DTC663E	●				0.9
IMH21	10/—		DTC614T	●				0.9

Features

- Low $R_{DS(on)}$
- High h_{FE}
- $BV_{EBO}=12V, 25V$
- Compound packages

Applications



Home Audio



Car Stereo

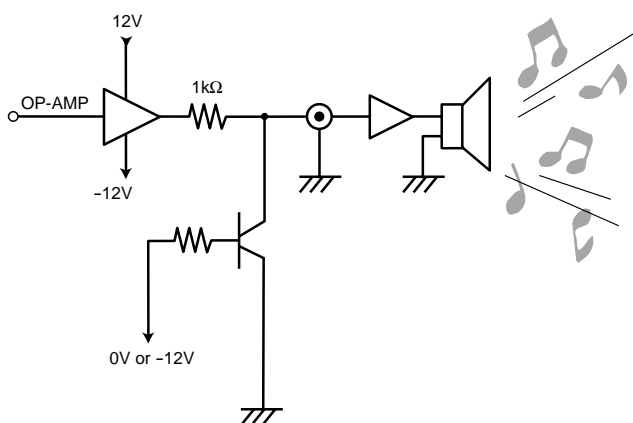

High- β • High- BV_{EBO}

Single type								
EMT3	UMT3	SMT3	SPT	$BV_{EBO}(V)$	$BV_{CEO}(V)$	$I_c(mA)$	h_{FE}	$R_{on}(\Omega)$
—	—	2SD2704K	2SD2705S	25	20	300	820~2700	0.7
2SD2654	2SD2351	2SD2226K	2SD2277S	12	50	150	820~2700	0.9
—	—	2SD2114K	2SD2144S	12	20	600	820~2700	0.8

Complex type								
EMT6	SMT6	Circuit	Elements	$BV_{EBO}(V)$	$BV_{CEO}(V)$	$I_c(mA)$	h_{FE}	$R_{on}(\Omega)$
—	IMX25		2SD2704K	25	20	300	800~2700	0.7
EMX26	—		2SD2654	12	50	150	820~2700	0.9
—	IMX9		2SD2114K	12	20	600	560~2700	0.8

External Dimensions (Unit:mm)

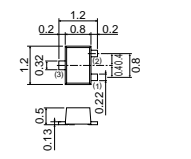
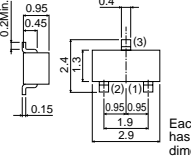
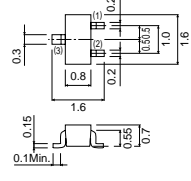
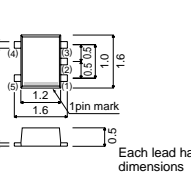
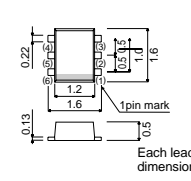
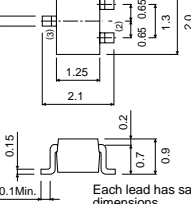
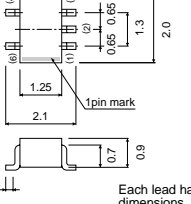
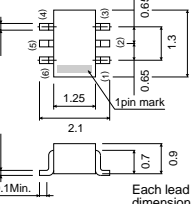
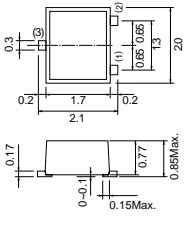
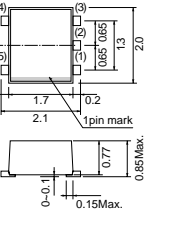
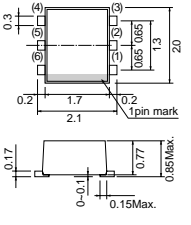
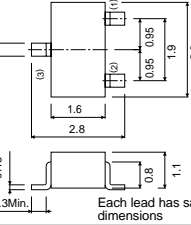
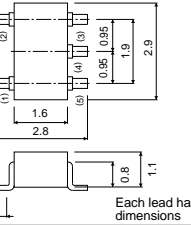
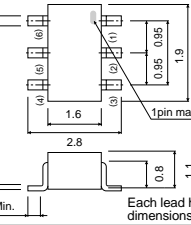
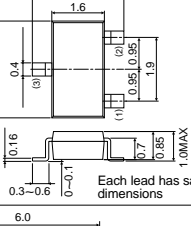
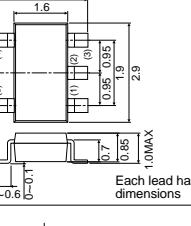
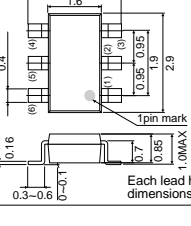
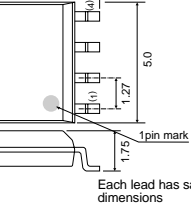
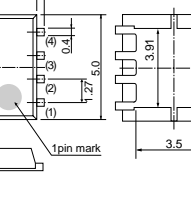
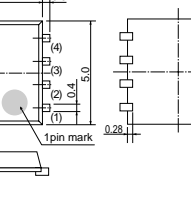
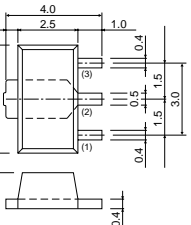
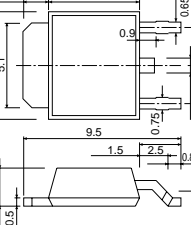
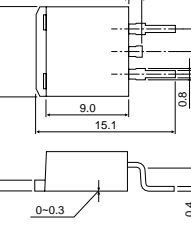
Surface mount devices	VMT3  (1)Base(IN)(Gate) (2)Emitter(GND)(Source) (3)Collector(OUT)(Drain)	SST3 <SOT-23>  (1)Emitter(GND)(Source) (2)Base(IN)(Gate) (3)Collector(OUT)(Drain) Each lead has same dimensions	
	EMT3 (SC-75A) <SOT-416>  (1)Emitter(GND)(Source) (2)Base(IN)(Gate) (3)Collector(OUT)(Drain)	EMT5  Each lead has same dimensions	EMT6  Each lead has same dimensions
	UMT3 (SC-70) <SOT-323>  (1)Emitter(GND)(Source) (2)Base(IN)(Gate) (3)Collector(OUT)(Drain)	UMT5 (SC-88A) <SOT-353>  Each lead has same dimensions	UMT6 (SC-88) <SOT-363>  Each lead has same dimensions
	TUMT3  (1)Base(Gate) (2)Emitter(Source) (3)Collector(Drain)	TUMT5  Each lead has same dimensions	TUMT6  Each lead has same dimensions
	SMT3 (SC-59) <SOT-346>  (1)Emitter(GND)(Source) (2)Base(IN)(Gate) (3)Collector(OUT)(Drain)	SMT5 (SC-74A)  Each lead has same dimensions	SMT6 (SC-74) <SOT-457>  Each lead has same dimensions
	TSMT3  (1)Base(Gate) (2)Emitter(Source) (3)Collector(Drain)	TSMT5  Each lead has same dimensions	TSMT6  Each lead has same dimensions
	SOP8  Each lead has same dimensions	PSOP8  Each lead has same dimensions	PSOP8S  Each lead has same dimensions
	MPT3 (SC-62) <SOT-89>  (1)Base(Gate) (2)Collector(Drain) (3)Emitter(Source)	CPT3 (SC-63) <SOT-428>  (1)Base(Gate) (2)Collector(Drain) (3)Emitter(Source)	D2PAK 

Notes: 1) Characters in () under package designation denotes JEITA No. Characters in < > under package designation denotes JEDEC No. 2) For dimensions refer to the data sheet.

Through-hole devices

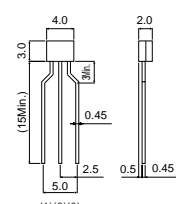
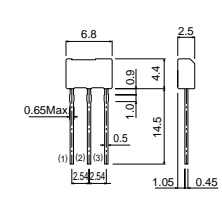
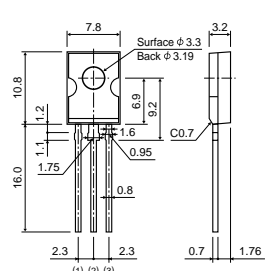
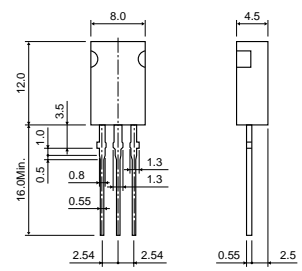
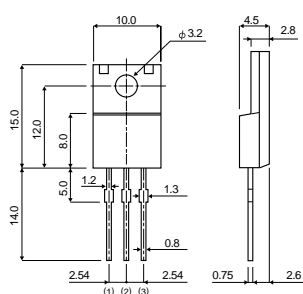
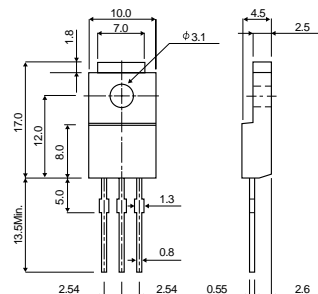
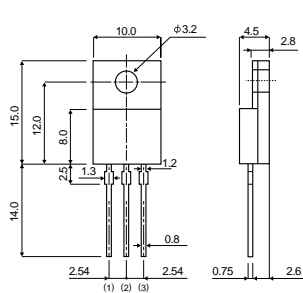
<p>SPT (SC-72)</p>  <p>(1)Emitter (2)Collector (3)Base</p>	<p>ATV</p>  <p>(1)Emitter (2)Collector (3)Base</p>
<p>TO-126FP</p>  <p>(1)Emitter (2)Collector (3)Base</p>	<p>HRT</p>  <p>(1)Emitter (2)Collector (3)Base</p>
<p>TO-220FN</p>  <p>(1)Base(Gate) (2)Collector(Drain) (3)Emitter(Source)</p>	<p>TO-220FP</p>  <p>(1)Base (2)Collector (3)Emitter</p>
<p>TO-220FM</p>  <p>(1)Base(Gate) (2)Collector(Drain) (3)Emitter(Source)</p>	<p></p>

Notes: 1) Characters in () under package designation denotes JEITA No. Characters in < > under package designation denotes JEDEC No. 2) For dimensions refer to the data sheet.

● The contents described herein are correct as of Oct, 2004.

● ROHM assumes no responsibility for the use of any circuits described herein, conveys no license under any patent or other right, and makes no representations that the circuits are free from patent infringement. Specifications subject to change without notice for the purpose of improvement.

The products listed in this catalog are designed to be used with ordinary electronic equipment or devices (such as audio visual equipment, office-automation equipment, communications devices, electrical appliances and electronic toys). Should you intend to use these products with equipment or devices which require an extremely high level of reliability and the malfunction of which would directly endanger human life (such as medical instruments, transportation equipment, aerospace machinery, nuclear-reactor controllers, fuel controllers and other safety devices), please be sure to consult with our sales representative in advance.

Excellence in Electronics



ROHM CO., LTD.

21, Saiin Mizosaki-cho, Ukyo-ku, Kyoto
615-8585, Japan
TEL: (075)311-2121 FAX: (075)315-0172
URL <http://www.rohm.com>

Contact us for further information about the products.

Atlanta U.S.A. / ROHM ELECTRONICS ATLANTA SALES OFFICE
(DIVISION OF ROHM ELE.U.S.A.,LLC)
TEL:+1(770)754-5972 FAX:+1(770)754-0691

Dallas U.S.A. / ROHM ELECTRONICS DALLAS SALES OFFICE
(DIVISION OF ROHM ELE.U.S.A.,LLC)
TEL:+1(972)312-8819 FAX:+1(972)312-0330

San Diego U.S.A. / ROHM ELECTRONICS SAN DIEGO SALES OFFICE
(DIVISION OF ROHM ELE.U.S.A.,LLC)
TEL:+1(858)625-3630 FAX:+1(858)625-3670

Germany / ROHM ELECTRONICS GMBH (GERMANY)
TEL:+49(2154)9210 FAX:+49(2154)921400

United Kingdom / ROHM ELECTRONICS GMBH (UK)
TEL:+44(0)1908-306700 FAX:+44(0)1908-235788

France / ROHM ELECTRONICS GMBH (FRANCE)
TEL:+33(1)41 23 14 00 FAX:+33(1)4123-1430

Hong Kong China / ROHM ELECTRONICS (H.K.) CO., LTD.
TEL:+852(2)7406262 FAX:+852(2)375-8971

Shanghai China / ROHM ELECTRONICS (SHANGHAI) CO., LTD.
TEL:+86(21)6279-2727 FAX:+86(21)6247-2066

Dalian China / ROHM ELECTRONICS TRADING (DALIAN) CO., LTD.
TEL:+86(411)8230-8549 FAX:+86(411)8230-8537

Beijing China / BEIJING REPRESENTATIVE OFFICE
TEL:+86(10)8525-2483 FAX:+86(10)8525-2489

Taiwan / ROHM ELECTRONICS TAIWAN CO., LTD.
TEL:+886(2)2500-6956 FAX:+886(2)2503-2869

Korea / ROHM ELECTRONICS KOREA CORPORATION
TEL:+82(2)8182-700 FAX:+82(2)8182-715

Singapore / ROHM ELECTRONICS ASIA PTE.LTD. (RES/REI)
TEL:+65-6332-2322 FAX:+65-6332-5662

Malaysia / ROHM ELECTRONICS (MALAYSIA) SDN. BHD.
TEL:+60(3)7958-8355 FAX:+60(3)7958-8377

Philippines / ROHM ELECTRONICS (PHILIPPINES) SALES CORPORATION
TEL:+63(2)807-6872 FAX:+63(2)809-1422

Thailand / ROHM ELECTRONICS (THAILAND) CO., LTD.
TEL:+66(2)254-4890 FAX:+66(2)256-6334