

OUTLINE

The R5426xxxxx Series are protection ICs for over-charge/discharge of rechargeable one-cell Lithium-ion (Li+) / Lithium polymer excess load current, further include a short circuit protector for preventing large external short circuit current and Excess charge/discharge-current.

Each of these ICs is composed of four voltage detectors, a reference unit, a delay circuit, a short circuit protector, an oscillator, a counter, and a logic circuit. When Over-charge voltage or Excess charge-current threshold crosses the each detector threshold from a low value to a high value, the output of C_{OUT} pin switches to low level after internal fixed delay time. After detecting over-charge or excess charge current, these detectors can be reset and the output of C_{OUT} becomes "H" when a kind of load is connected to V_{DD} after a charger is disconnected from the battery pack, and the cell voltage becomes lower than over-charge detector threshold. If a charger is continue to be connected to the battery pack, even the cell voltage becomes lower than over-charge detector threshold, over-charge state is not released.

The output of D_{OUT} pin, the output of Over-discharge detector and Excess discharge-current detector, switches to low level after internally fixed delay time, when discharged voltage crosses the detector threshold from a high value to a value lower than V_{DET2}.

After detecting over-discharge voltage, connect a charger to the battery pack, and when the battery supply voltage becomes higher than over-discharge detector threshold, VD2 is released and the voltage of D_{OUT} pin becomes "H" level.

An excess discharge-current and short circuit state can be sensed and cut off through the built in excess current detector, VD3, with D_{OUT} being enabled to low level. Once after detecting excess discharge-current or short circuit, the VD3 is released and D_{OUT} level switches to high by detaching a battery pack from a load system.

After detecting over-discharge, supply current will be kept extremely low by halting internal circuits' operation. By setting the DS pin at V_{DD} level, the output delay of all items except short circuit detector can be shortened. Especially, the delay time of over-charge detector can be reduced into approximately 1/90, therefore, testing time of protector circuit board can be reduced. Further, when the DS pin is set at the specified middle range voltage, output delay circuit is disabled, then over-charge and over-charger current can be detected immediately. Output delay time would be less than several tens μ s in this case. Output type of C_{OUT} and D_{OUT} are CMOS. 6-pin, SOT-23-6 or SON6 are available.

FEATURES

- Manufactured with High Voltage Tolerant Process Absolute Maximum Rating 28V
- Low supply current Supply current (At normal mode) Typ. 3.0 μ A
Standby current (detecting over-discharge) Max. 0.1 μ A
- High accuracy detector threshold Over-charge detector (T_{opt}=25°C) \pm 25mV
(T_{opt}=-5 to 55°C) \pm 30mV
Over-discharge detector \pm 2.5%
Excess discharge-current detector \pm 20mV
Excess charge-current detector \pm 30mV
- Variety of detector threshold Over-charge detector threshold 4.0V-4.5V step of 0.005V
Over-discharge detector threshold 2.0V-3.0V step of 0.005V
Excess discharge-current threshold 0.05V-0.4V step of 0.005V
Excess charge-current threshold Fixed at -0.1V
- Internal fixed Output delay time Over-charge detector Output Delay 250ms/1s/5s
(Select among the options) Over-discharge detector Output Delay 20ms
Excess discharge-current detector Output Delay 6ms/12ms
Short Circuit detector Output Delay 400 μ s
Excess charge-current detector Output Delay 8ms/16ms/1s
- DS pin At V_{DD} level, Output Delay time of all items except short-circuit can be reduced. (Delay Time for over-charge becomes about 1/90 of normal state.) At the specified middle range level, delay circuit is disabled.
- 0V-battery charge option acceptable/unacceptable
- With Latch function after over-charge detect
- Ultra Small package SOT-23-6 / SON6 6-pin

APPLICATIONS

- Li+ / Li Polymer protector of over-charge, over-discharge, excess-current for battery pack
- High precision protectors for cell-phones and any other gadgets using on board Li+ / Li Polymer battery

BLOCK DIAGRAM

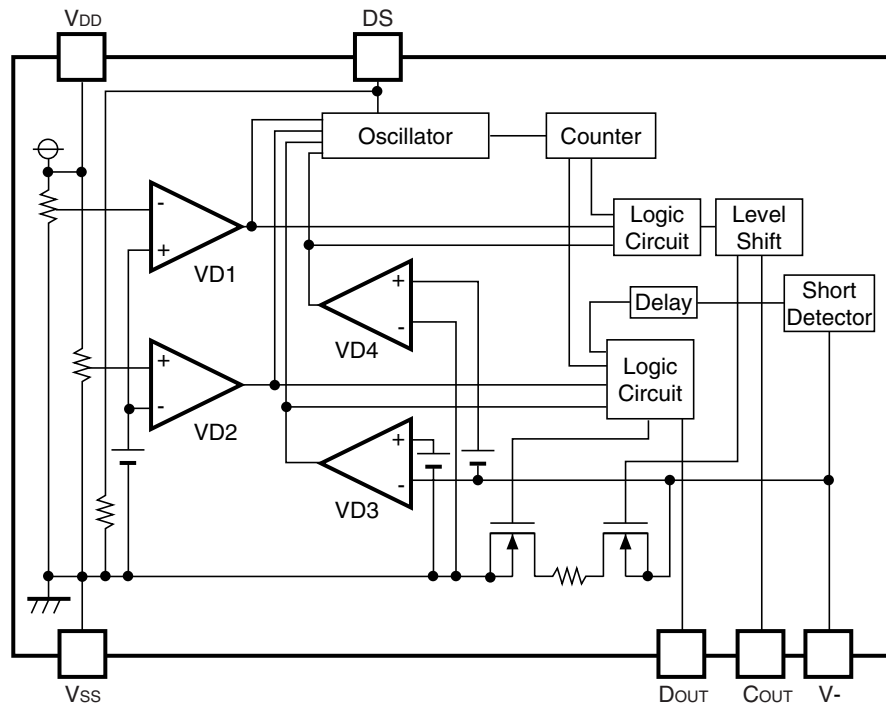

SELECTION GUIDE

In the R5426xxxxx Series four of the input threshold for over-charge, over-discharge, excess discharge current, and excess charge current detectors, package type can be designated.

Part Number is designated as follows:

R5426x xxxxx-xx ←Part Number
 ↑ ↑ ↑↑ ↑
 a b cd e

Code	Contents
a	Package Type N: SOT-23-6 D: SON6
b	Serial Number for the R5426 Series designating input four threshold for over-charge, over-discharge, excess discharge-current, and excess charge-current detectors.
c	Designation of Output delay option of over-charge, excess charge-current, and excess discharge-current.
d	Designation of version symbols
e	Taping Type: TR (refer to Taping Specification)

PIN CONFIGURATIONS

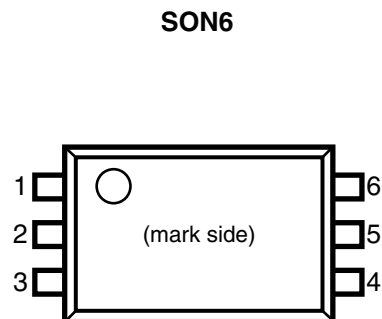
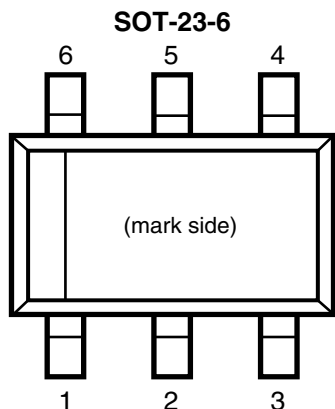

PIN DESCRIPTION

Pin No.		Symbol	Description
SOT-23-6	SON6		
1	1	D _{OUT}	Output of over-discharge detection, CMOS output
2	6	V ₋	Pin for charger negative input
3	5	C _{OUT}	Output of over-charge detection, CMOS output
4	4	DS	Pin for reduce pre-set output delay time
5	2	V _{DD}	Power supply pin, the substrate voltage level of the IC.
6	3	V _{SS}	Ground pin for the IC

ABSOLUTE MAXIMUM RATINGS

$V_{SS}=0V$

Symbol	Item	Ratings	Unit
V_{DD}	Supply voltage	-0.3 to 12	V
V_{-}	Input Voltage V- pin	$V_{DD} - 28$ to $V_{DD} + 0.3$	V
V_{DS}	DS pin	$V_{SS} - 0.3$ to $V_{DD} + 0.3$	V
V_{COUT}	Output voltage C _{OUT} pin	$V_{DD} - 28$ to $V_{DD} + 0.3$	V
V_{DOUT}	D _{OUT} pin	$V_{SS} - 0.3$ to $V_{DD} + 0.3$	V
P_D	Power dissipation	150	mW
T_{opt}	Operating temperature range	-40 to 85	°C
T_{stg}	Storage temperature range	-55 to 125	°C

ABSOLUTE MAXIMUM RATINGS

Absolute Maximum ratings are threshold limit values that must not be exceeded ever for an instant under any conditions. Moreover, such values for any two items must not be reached simultaneously. Operation above these absolute maximum ratings may cause degradation or permanent damage to the device. These are stress ratings only and do not necessarily imply functional operation below these limits.

ELECTRICAL CHARACTERISTICS

Unless otherwise specified, T_{opt}=25°C

Symbol	Item	Conditions	Min.	Typ.	Max.	Unit
V _{DD1}	Operating input voltage	Voltage defined as V _{DD} -V _{SS}	1.5		5.0	V
V _{st}	Minimum operating Voltage for 0V charging ^{*Note 1}	Voltage defined as V _{DD} -V ₋ , V _{DD} -V _{SS} =0V			1.5	V
V _{nochg}	Maximum Battery Voltage level of low voltage battery charge inhibitory circuit ^{*Note 2}	Voltage defined as V _{DD} -V _{SS} , V _{DD} -V ₋ =4V	0.6	1.0	1.4	V
V _{DET1}	Over-charge threshold	Detect rising edge of supply voltage R1=330Ω R1=330Ω (T _{opt} =-5 to 55°C) ^{*Note3}	V _{DET1} -0.025 V _{DET1} -0.030	V _{DET1} V _{DET1}	V _{DET1} +0.025 V _{DET1} +0.030	V V
t _{VDET1}	Output delay of over-charge	V _{DD} =3.6V to 4.4V	t _{VDET1} ×0.7	t _{VDET1}	t _{VDET1} ×1.3	s
t _{VREL1}	Output delay of release from over-charge	V _{DD} =4V, V ₋ =0V to 1V	11	16	21	ms
V _{DET2}	Over-discharge threshold	Detect falling edge of supply voltage	V _{DET2} ×0.975	V _{DET2}	V _{DET2} ×1.025	V
t _{VDET2}	Output delay of over-discharge	V _{DD} =3.6V to 2.2V	14	20	26	ms
t _{VREL2}	Output delay of release from over-discharge	V _{DD} =3V V ₋ =3V to 0V	0.7	1.2	1.7	ms
V _{DET3}	Excess discharge-current threshold	Detect rising edge of 'V-' pin voltage	V _{DET3} -0.020	V _{DET3}	V _{DET3} +0.020	V
t _{VDET3}	Output delay of excess discharge-current	V _{DD} =3.0V, V ₋ =0V to 1V 6ms type 12ms type	4 8	6 12	8 16	ms
t _{VREL3}	Output delay of release from excess dis- charge-current	V _{DD} =3.0V, V ₋ =3V to 0V	0.7	1.2	1.7	ms
V _{DET4}	Excess charge-current threshold	Detect falling edge of 'V-' pin voltage	-0.13	-0.10	-0.07	V
t _{VDET4}	Output delay of excess charge-current	V _{DD} =3.0V V ₋ =0V to -1V 8ms type 16ms type 1000ms type	5 11 700	8 16 1000	11 21 1300	ms
t _{VREL4}	Output delay of release from excess charge- current	V _{DD} =3.0V, V ₋ =-1V to 0V	0.7	1.2	1.7	ms
V _{short}	Short protection voltage	V _{DD} =3.0V	V _{DD} -1.4	V _{DD} -1.1	V _{DD} -0.8	V
T _{short}	Output Delay of Short protection	V _{DD} =3.0V, V ₋ =0V to 3V	250	400	600	μs
R _{short}	Reset resistance for Excess discharge- current protection	V _{DD} =3.6V, V ₋ =1V	15	30	45	kΩ
V _{IH}	DS pin "H" input voltage		V _{DD} -0.5		V _{DD} +0.3	V
V _{IM}	DS pin "M" input voltage	V _{DD} =3.6V to 4.4V	1.2		V _{DD} -1.1	V
R _{DS}	DS pin pull-down resistance	V _{DD} =3.6V	0.5	1.3	2.5	MΩ
V _{OL1}	Nch ON voltage of COUT	I _{ol} =50μA, V _{DD} =4.5V		0.4	0.5	V
V _{OH1}	Pch ON voltage of COUT	I _{oh} =-50μA, V _{DD} =3.9V	3.4	3.7		V
V _{OL2}	Nch ON voltage of DOUT	I _{ol} =50μA, V _{DD} =2.0V		0.2	0.5	V
V _{OH2}	Pch ON voltage of DOUT	I _{oh} =-50μA, V _{DD} =3.9V	3.4	3.7		V
I _{DD}	Supply current	V _{DD} =3.9V, V ₋ =0V		3.0	6.0	μA
I _s	Standby current	V _{DD} =2.0V			0.1	μA

*Note1: Specified for A version

*Note2: Specified for B version

*Note3: We compensate for this characteristic related to temperature by laser-trim, however, this specification is guaranteed by design, not production tested.

OPERATION

• VD1 / Over-Charge Detector

The VD1 monitors V_{DD} pin voltage while charge the battery pack. When the V_{DD} voltage crosses over-charge detector threshold V_{DET1} from a low value to a value higher than the V_{DET1} , the VD1 can sense a over-charging and an external charge control Nch MOSFET turns off with C_{OUT} pin being at "L" level.

To reset the VD1 making the C_{OUT} pin level to "H" again after detecting over-charge, in such conditions that a time when the V_{DD} voltage is down to a level lower than over-charge voltage.

Connecting a kind of loading to V_{DD} after disconnecting a charger from the battery pack when the V_{DD} voltage is lower than Over-charge detector threshold, VD1 can be reset. Output voltage of C_{OUT} pin becomes "H", and it makes an external Nch MOSFET turn on, and charge cycle is available. In other words, once over-charge is detected, even the supply voltage becomes low enough, if a charger is continue to be connected to the battery pack, recharge is not possible. Therefore this over-charge detector has no hysteresis. To judge whether or not load is connected, Excess-discharge current detector is used. In other words, by connecting some load, V_{-} pin voltage becomes equal or more than Excess-discharge current detector threshold, and reset Over-charge detecting state.

After detecting over-charge with the V_{DD} voltage of higher than V_{DET1} , connecting system load to the battery pack makes load current allowable through parasitic diode of external charge control FET.

The C_{OUT} level would be "H" when the V_{DD} level is down to a level below the V_{DET1} by continuous drawing of load current.

Internal fixed output delay times for over-charge detection and release from over-charge exist. Even when the V_{DD} level becomes a higher level than V_{DET1} if the V_{DD} voltage would be back to a level lower than the V_{DET1} within a time period of the output delay time, VD1 would not output a signal for turning off the charge control FET. Besides, after detecting over-charge, while the V_{DD} is lower than over-charge detector, even if a charger is removed and connect a load, when the voltage is recovered within output delay time of release from over-charge, over-charge state is not released.

A level shifter incorporated in a buffer driver for the C_{OUT} pin makes the "L" level of C_{OUT} pin to the V_{-} pin voltage and the "H" level of C_{OUT} pin is set to V_{DD} voltage with CMOS buffer.

• VD2 / Over-Discharge Detector

The VD2 is monitoring a V_{DD} pin voltage. When the V_{DD} voltage crosses the over-discharge detector threshold V_{DET2} from a high value to a value lower than the V_{DET2} , the VD2 can sense an over-discharging and the external discharge control Nch MOSFET turns off with the D_{OUT} pin being at "L" level.

To reset the VD2 with the D_{OUT} pin level being "H" again after detecting over discharge, it is necessary to connect a charger to the battery pack. When the V_{DD} voltage stays under over-discharge detector threshold V_{DET2} , charge-current can flow through parasitic diode of an external discharge control MOSFET, then after the V_{DD} voltage comes up to a value larger than V_{DET2} , then, D_{OUT} becomes "H" and discharging process would be able to advance through ON state MOSFET for discharge control.

Connecting a charger to the battery pack makes the D_{OUT} level being "H" instantaneously when the V_{DD} voltage is higher than V_{DET2} .

When a cell voltage equals to zero, operation varies and depends on the mask version.

A version: the voltage of a charger is equal or more than 0V-charge minimum voltage (V_{st}), C_{OUT} pin becomes "H" and system allowable to charge

B Version: when the V_{DD} pin voltage is equal or lower than charge inhibitory maximum voltage (V_{nochg}), even a charger is connected to a battery pack, C_{OUT} pin is stacked at "L" and charge current cannot flow.

An output delay time for over-discharge detection is fixed internally. When the V_{DD} level is down to a lower level than V_{DET2} if the V_{DD} voltage would be back to a level higher than the V_{DET2} within a time period of the output delay time, $VD2$ would not output a signal for turning off the discharge control FET. Output delay time for release from over-discharge is also set typically at 1.2ms.

After detecting of over-discharge by $VD2$, supply current would be reduced to maximum $0.1\mu A$ at $V_{DD}=2.0V$ and be into standby by halting all circuits and consumption current of IC itself is minimized.

The output type of D_{OUT} pin is CMOS having "H" level of V_{DD} and "L" level of V_{SS} .

- **VD3 /Excess discharge-current Detector, Short Circuit Protector**

Both of the excess current detector and short circuit protection can work when the both of control FETs are in "ON" state.

When the V- pin voltage is up to a value between the short protection voltage V_{short}/V_{DD} and excess discharge-current threshold V_{DET3} (Typically $V_{DD}-1.1V$), $VD3$ operates and further soaring of V- pin voltage higher than V_{short} makes the short circuit protector enabled. This leads the external discharge control Nch MOSFET turns off with the D_{OUT} pin being at "L" level.

An output delay time for the excess discharge-current detector is internally fixed.

A quick recovery of V- pin level from a value between V_{short} and V_{DET3} within the delay time keeps the discharge control FET staying "H" state. Output delay time for Release from excess discharge-current detection is also set at typically 1.2ms.

When the short circuit protector is enabled, the D_{OUT} would be "L" and its delay time would be typically $400\mu s$.

The V - pin has a built-in pulled down resistor, typically $30k\Omega$, with connecting to the V_{SS} pin.

After an excess discharge-current or short circuit protection is detected, removing a cause of excess discharge-current or external short circuit makes an external discharge control FET to an "ON" state automatically with the V- pin level being down to the V_{SS} level through built-in pulled down resistor. The reset resistor of excess discharge-current is off at normal state. Only when detecting excess discharge-current or short circuit, the resistor is on.

Output delay time of excess discharge-current is set shorter than the delay time for over-discharge detector. Therefore, if V_{DD} voltage would be lower than V_{DET2} at the same time as the excess discharge-current is detected, the R5426xxxxxx is at excess discharge-current detection mode. By disconnecting a load, $VD3$ is automatically released from excess discharge-current.

- **VD4/ Excess charge-current detector**

When the battery pack is chargeable and discharge is also possible, $VD4$ senses V- pin voltage. For example, if the battery pack is charged by an inappropriate charger, excess current flows, then the voltage of V- pin becomes equal or less than excess charge-current detector threshold. Then, the output of C_{OUT} becomes "L", and prevents from flowing excess current in the circuit by turning off the external Nch MOSFET.

Output delay of excess charge current is internally fixed. Even the voltage level of V- pin becomes equal or lower than excess charge-current detector threshold, the voltage is higher than the $VD4$ threshold within the delay time, excess charge-current state is not detected.

$VD4$ can be released by disconnecting a charger and setting a load.

- **DS (Delay Shorten) function**

Output delay time of over-charge, over-discharge, excess discharge-current, excess charge-current, and release from those detecting modes can be shorter than those setting value by forcing V_{DD} voltage to DS pin.

By forcing the specified middle range voltage to DS pin, Output Delay Circuit can be disabled. Therefore, under this condition, when over-charge or excess charge current is detected, output level can be checked without delay.

1.3M Ω pull-down resistor is connected between DS pin and V_{SS} internally.

At the normal operation, DS pin should be at no connection state.

TIMING CHART

1. Over-charge, Excess charge Current Operation

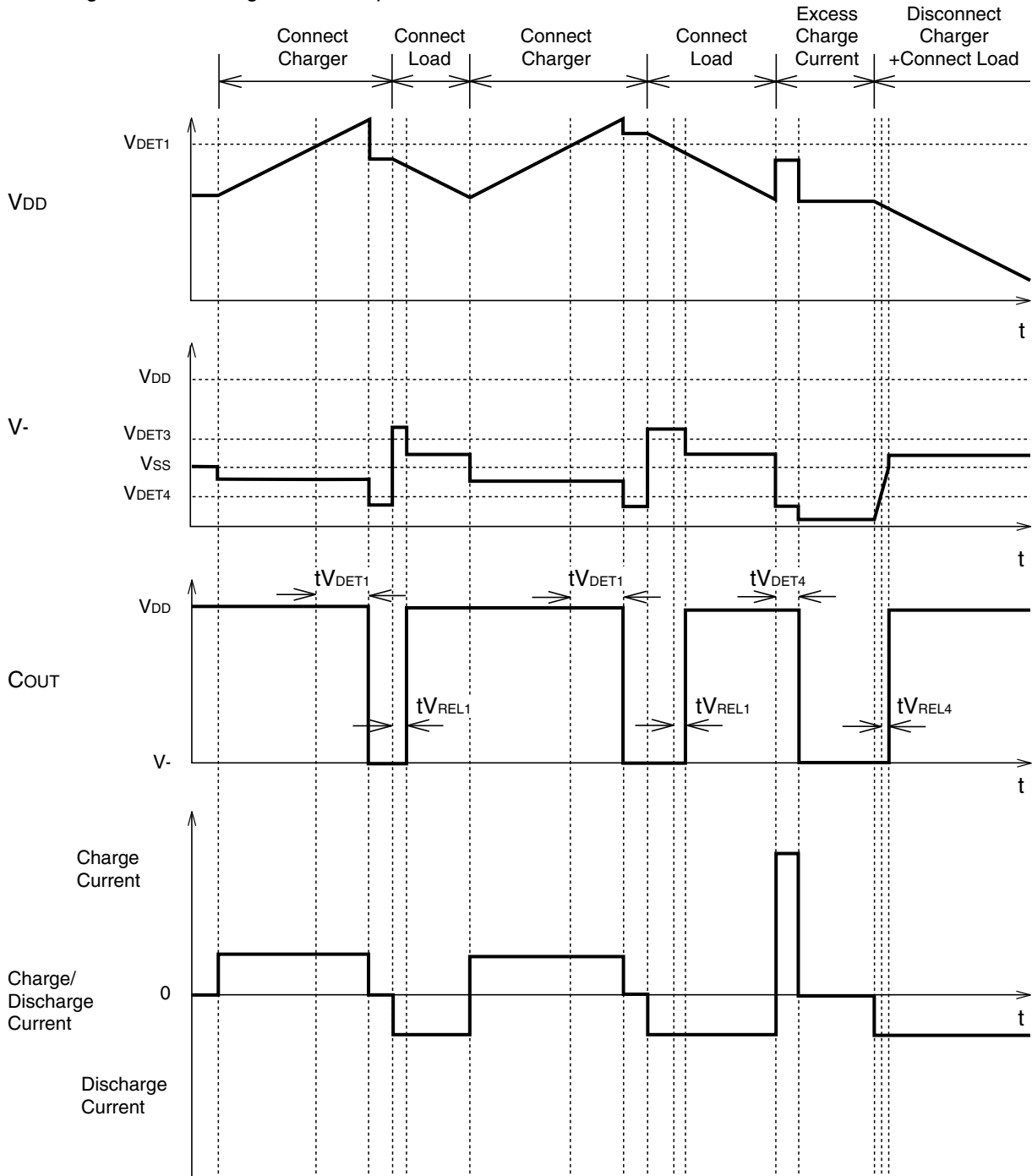

2. Over discharge, Excess discharge current, Short circuit operation

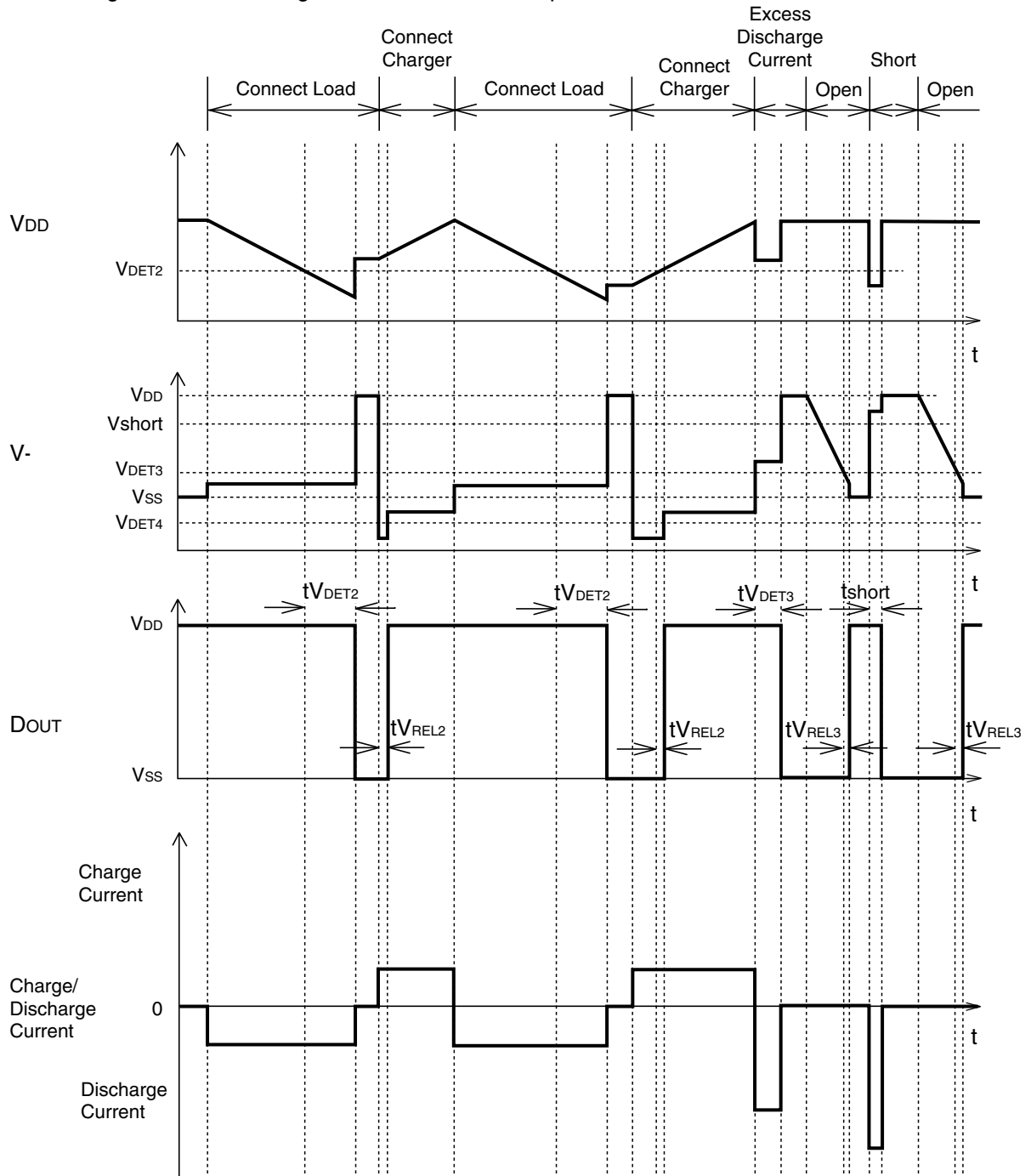

TYPICAL APPLICATION

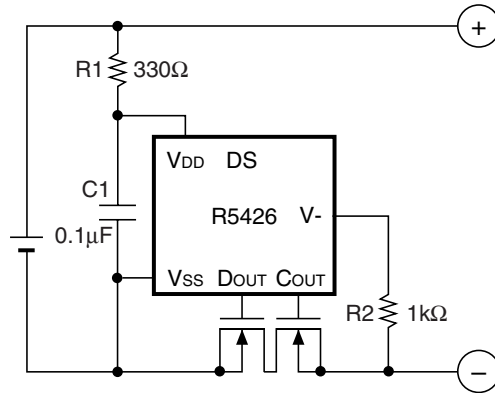

APPLICATION HINTS

R1 and C1 will stabilize a supply voltage to the R5426xxxxxx. A recommended R1 value is less than 1kΩ.

A larger value of R1 leads higher detection voltage, makes some errors, because of shoot through current flow in the R5426xxxxxx.

R1 and R2 can operate also as parts for current limit circuit against reverse charge or applying a charger with excess charging voltage to the R5426xxxxxx, battery pack. Small value of R1 and R2 may cause over-power consumption rating of power dissipation of the R5426xxxxxx. Therefore, total value of 'R1 + R2' should be equal or more than 1kΩ.

On the other hand, if large value of R2 is set, release from over-discharge by connecting a charger might not be possible. Recommended R2 value is equal or less than 30kΩ.

TEST CIRCUITS

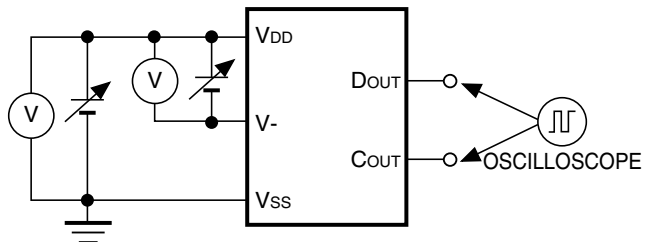

A

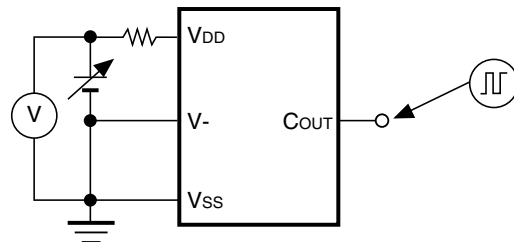

B

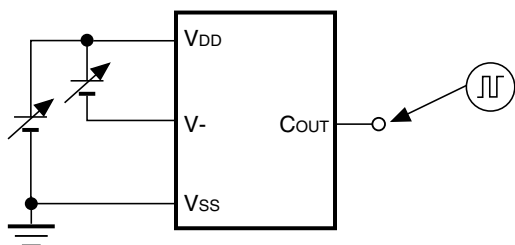

C

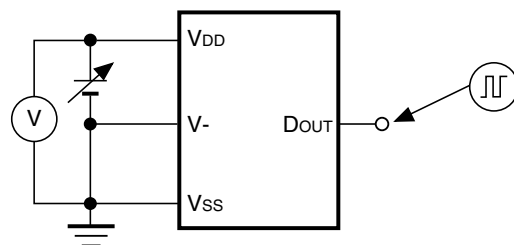

D

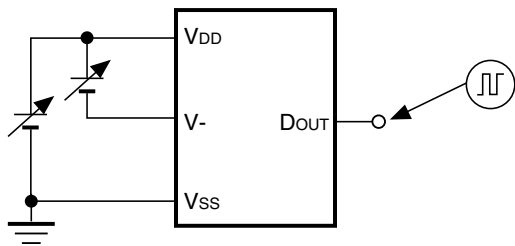

E

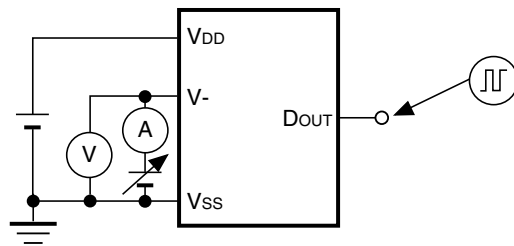

F

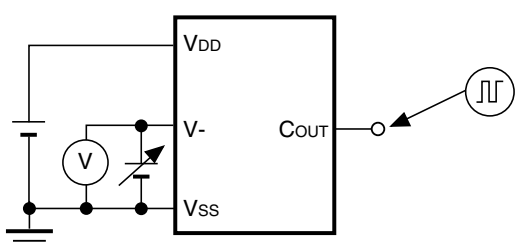

G

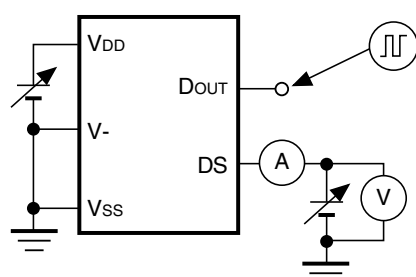

H

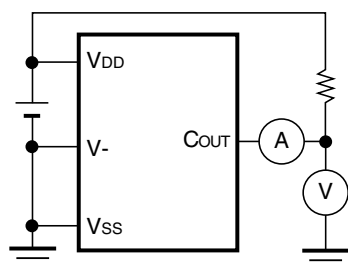

I

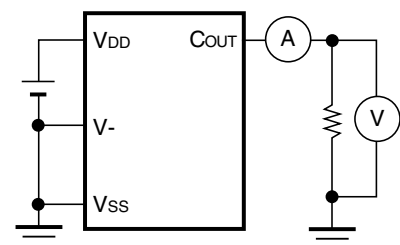

J

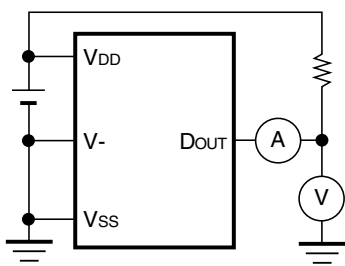

K

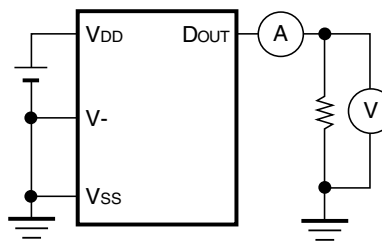

L

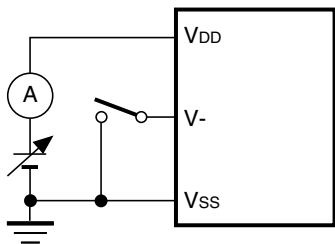

M

Typical Characteristics were obtained with using those above circuits:

- Test Circuit A: Typical characteristics 1) 2)
- Test Circuit B: Typical characteristics 3) 4)
- Test Circuit C: Typical characteristics 5)
- Test Circuit D: Typical characteristics 6) 7)
- Test Circuit E: Typical characteristics 8)
- Test Circuit F: Typical characteristics 9) 10) 11) 12) 13) 14)
- Test Circuit G: Typical characteristics 15) 16) 17)
- Test Circuit H: Typical characteristics 18) 19) 20)
- Test Circuit I: Typical characteristics 21)
- Test Circuit J: Typical characteristics 22)
- Test Circuit K: Typical characteristics 23)
- Test Circuit L: Typical characteristics 24)
- Test Circuit M: Typical characteristics 25) 26)

TYPICAL CHARACTERISTICS (Part 1)

- 1) Minimum Operating Voltage for 0V Cell Charging vs. Temperature
- 2) Maximum Battery Voltage Level for Low Voltage Battery Charge Inhibitory Circuit vs. Temperature

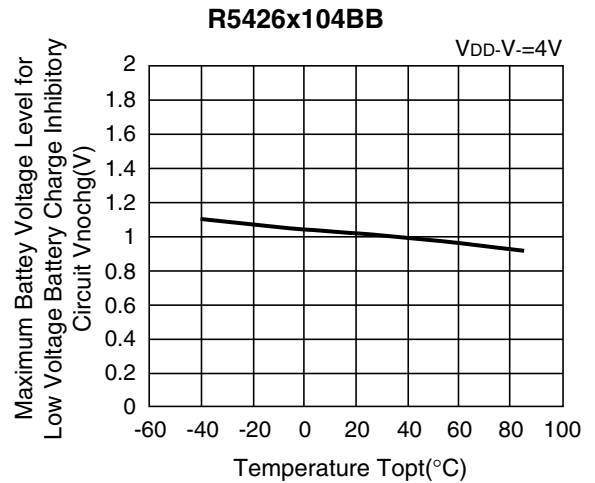
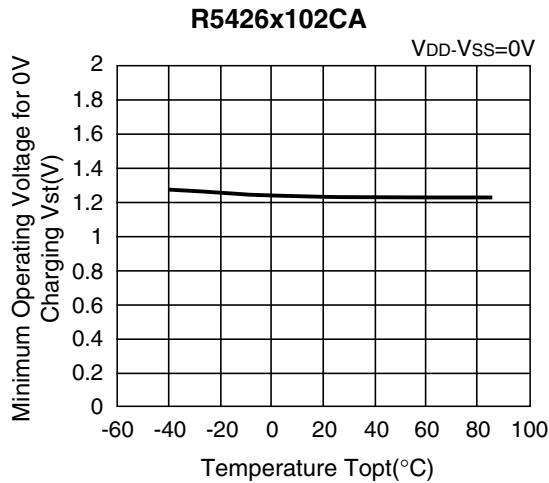

- 3) Over-Charge Threshold vs. Temperature
- 4) Output Delay of Over-charge vs. Temperature

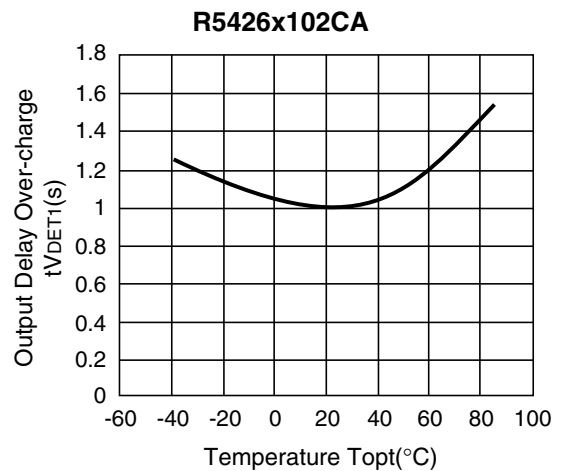
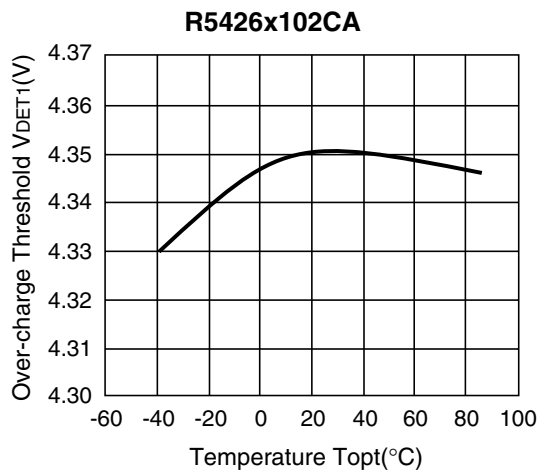

- 5) Output Delay of Release from Over-charge vs. Temperature
- 6) Over discharge Threshold vs. Temperature

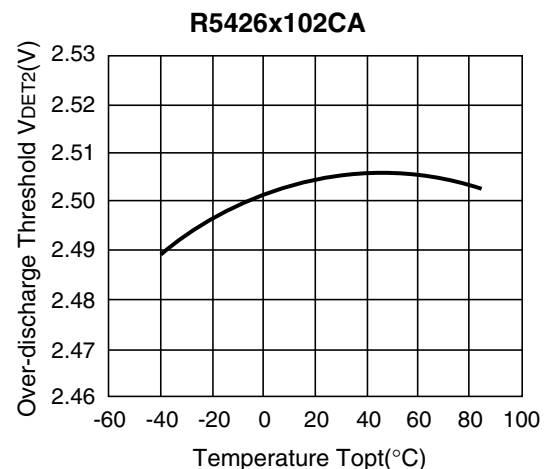
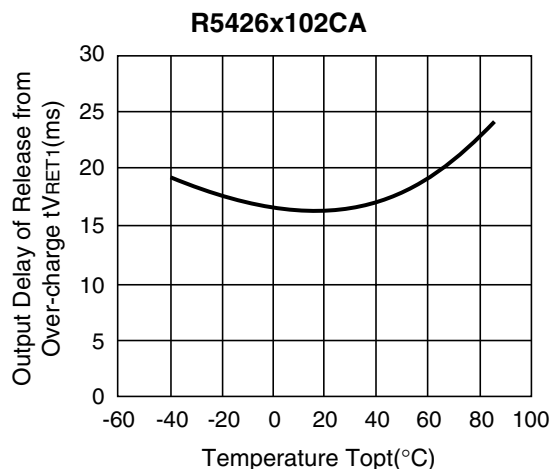

7) Output Delay of Over-discharge vs. Temperature

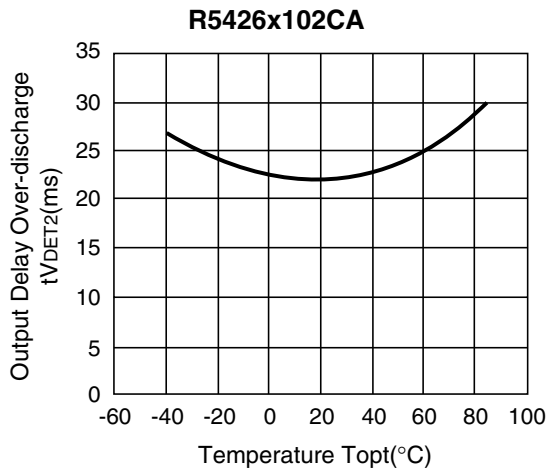

8) Output Delay of Release from Over-discharge vs. Temperature

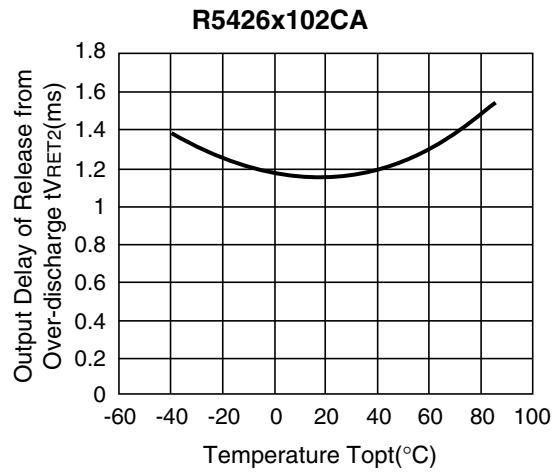

9) Excess Discharge-current Threshold vs. Temperature

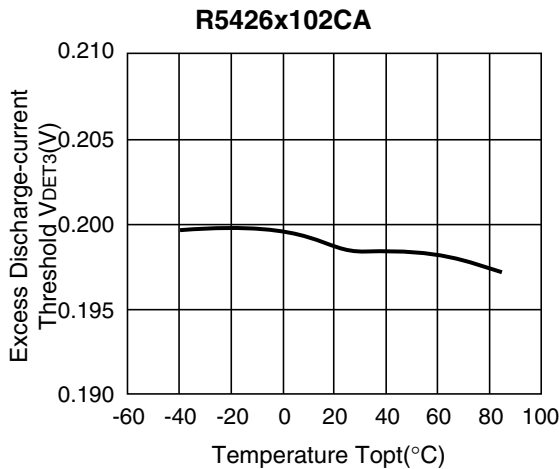

10) Output Delay of Excess Discharge-current vs. Temperature

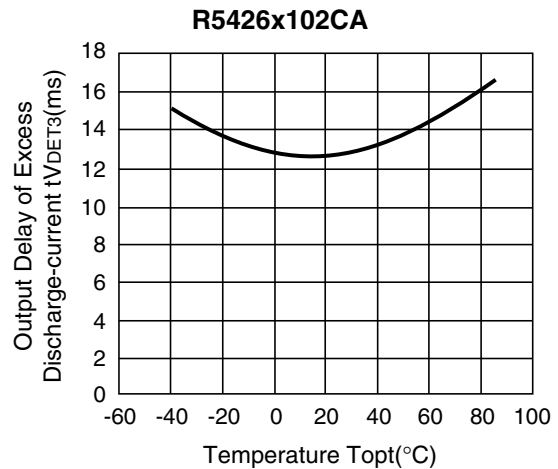

11) Output Delay of Release from Excess Discharge-current vs. Temperature

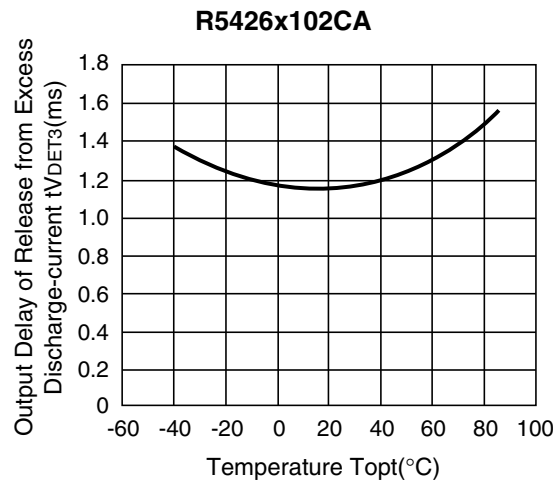

12) Short Protection Voltage vs. Temperature

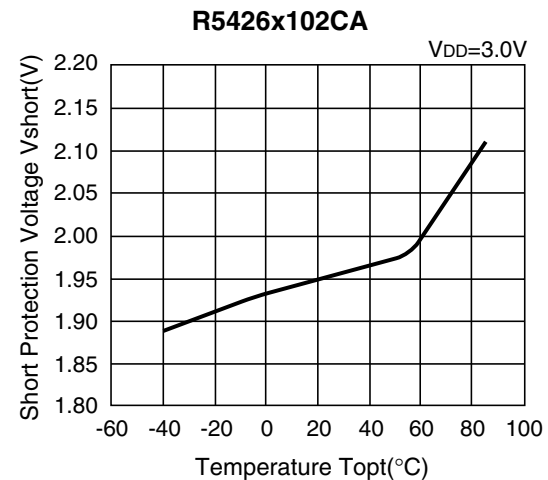

13) Output Delay of Short Protection vs. Temperature

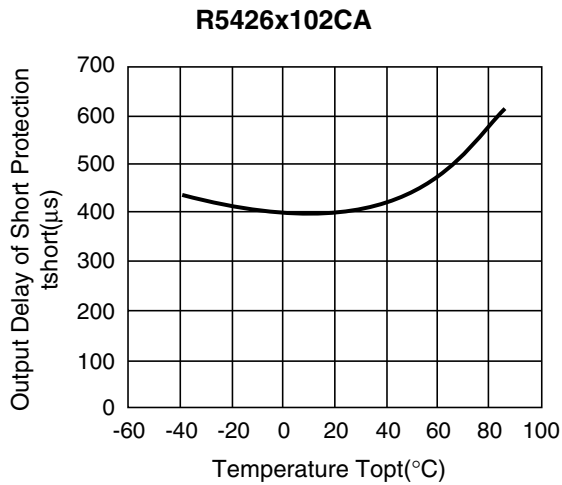

14) Reset Resistance for Excess Discharge current Protection vs. Temperature

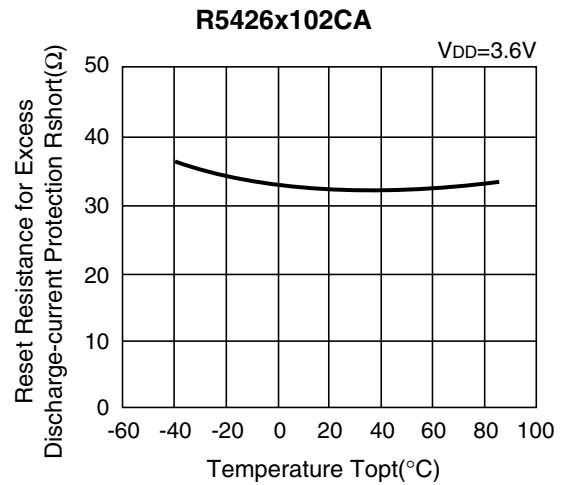

15) Excess Charge-current Threshold vs. Temperature

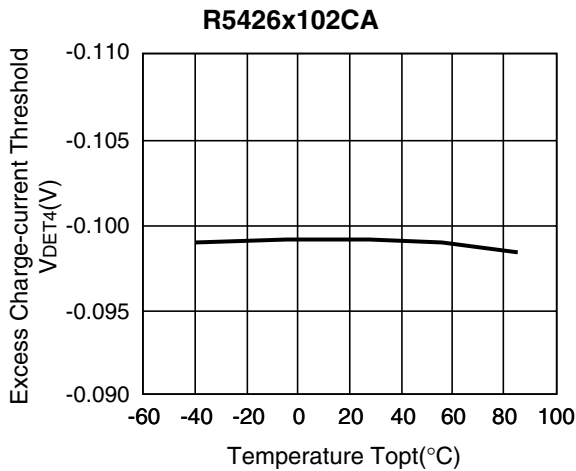

16) Output Delay of Excess Charge-current vs. Temperature

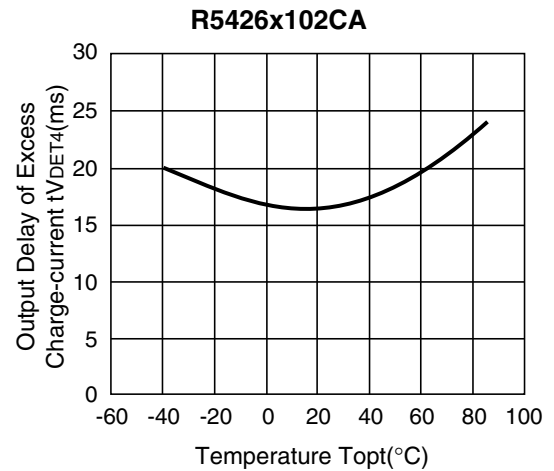

17) Output Delay of Release from Excess Charge-current vs. Temperature

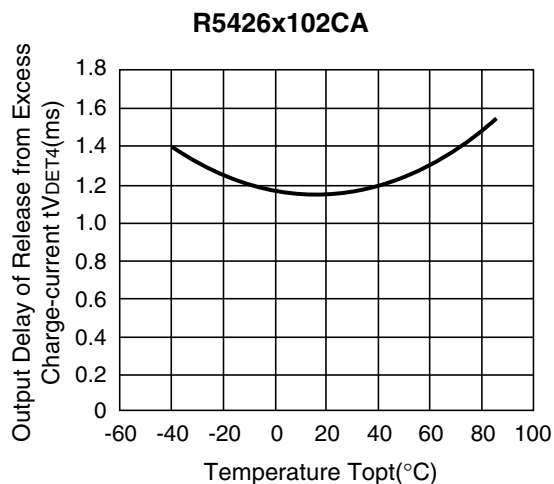

18) DS pin "H" Input Minimum Voltage vs. Temperature

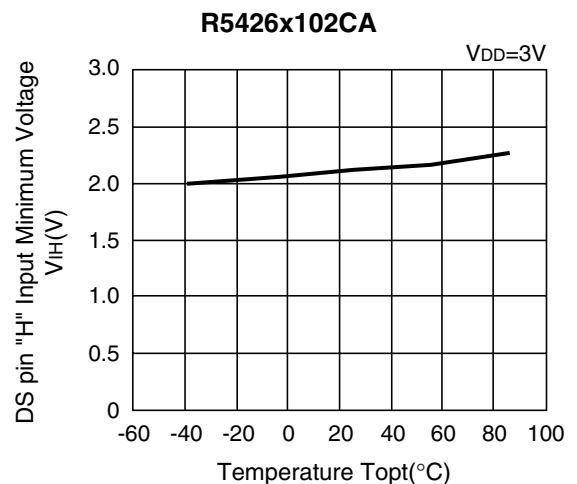

19) DS pin "M" Input Minimum Voltage vs. Temperature

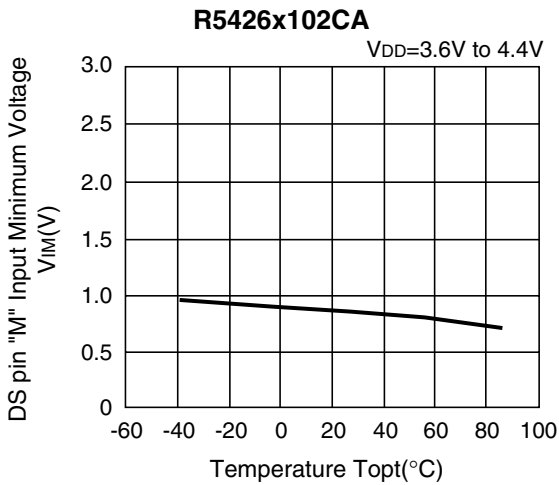

20) DS pin Pull-down Resistance vs. Temperature

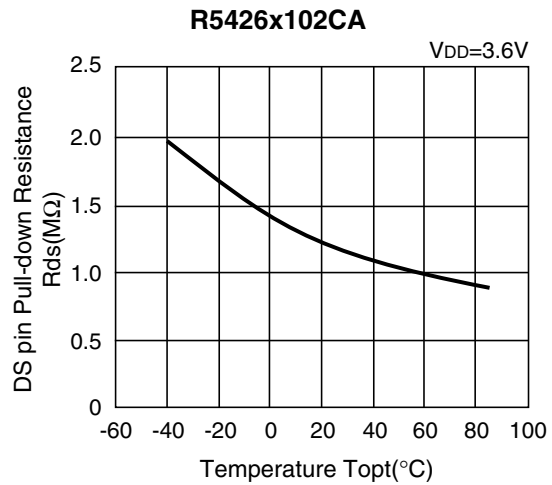

21) Nch ON Voltage of C_{OUT} vs. Temperature

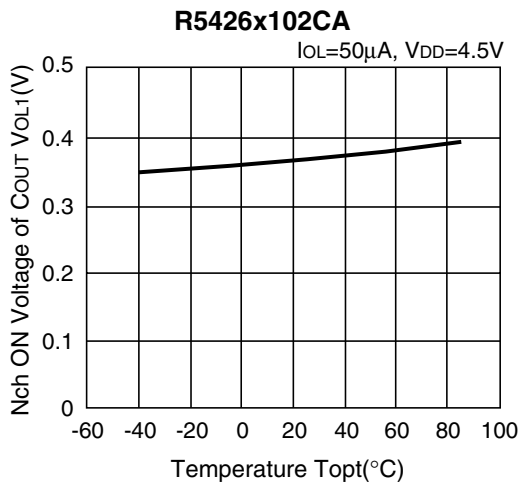

22) Pch ON Voltage of C_{OUT} vs. Temperature

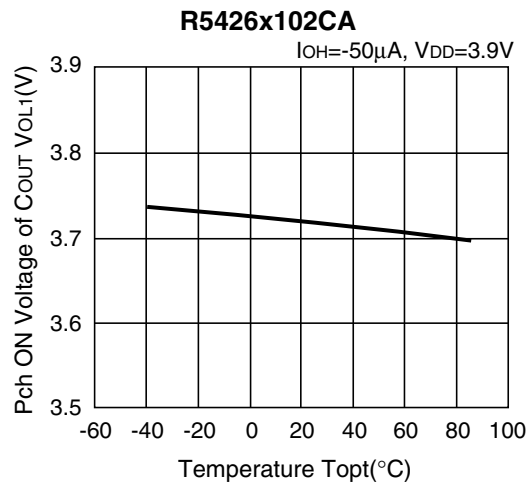

23) Nch ON Voltage of D_{OUT} vs. Temperature

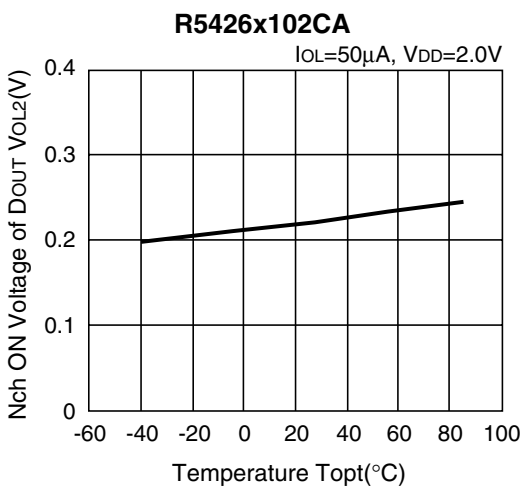

24) Pch ON Voltage of D_{OUT} vs. Temperature

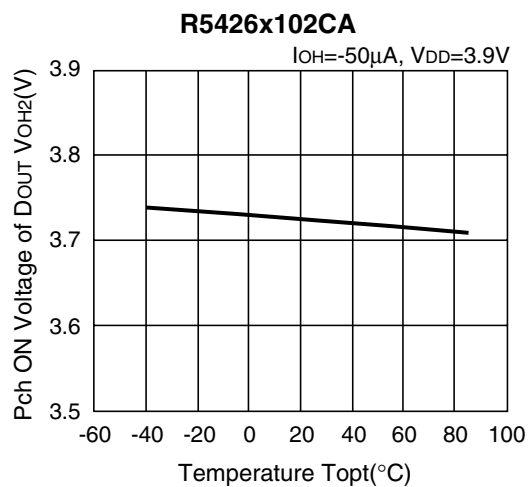

25) Supply Current vs. Temperature

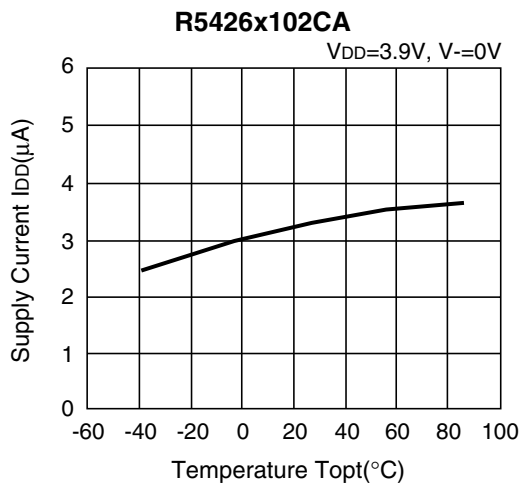

26) Standby Current vs. Temperature

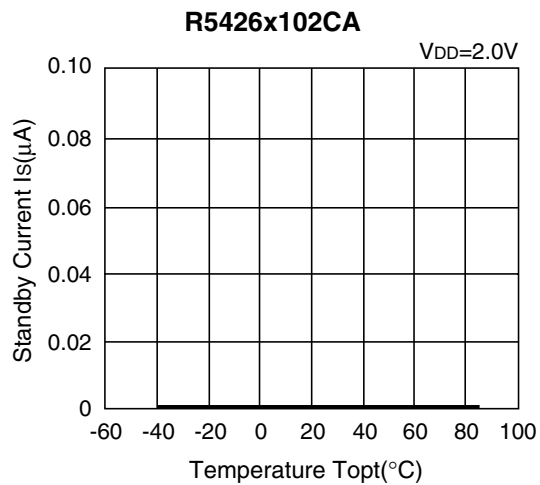

Part 2 Delay Time dependence on V_{DD}

1) Delay Time for Over-charge detect vs. V_{DD}

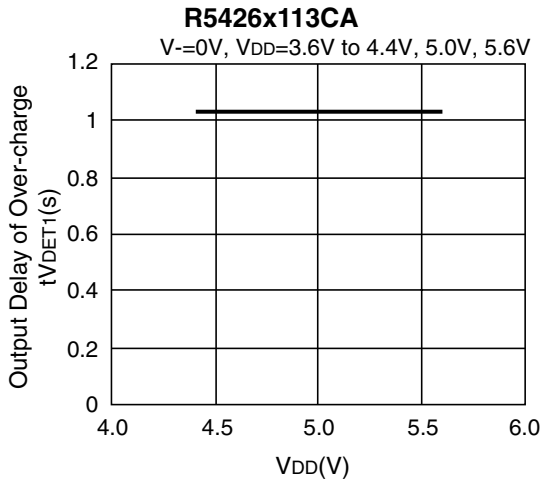

2) Delay Time for Release from Over-charge vs. V_{DD}

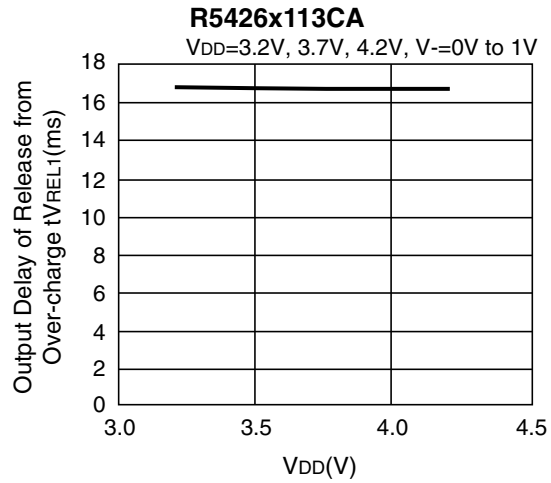

3) Output Delay of Over-discharge detect vs. V_{DD}

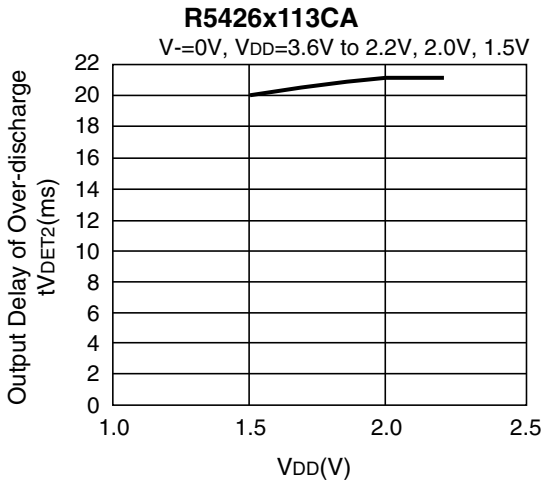

4) Output Delay for Release from Over-discharge vs. V_{DD}

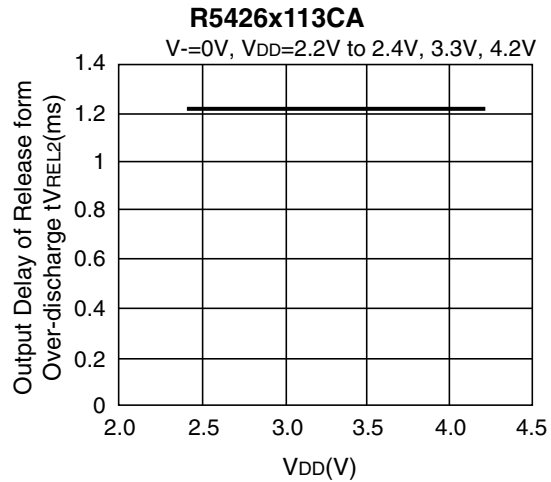

5) Output Delay for Excess Current during Discharge vs. V_{DD}

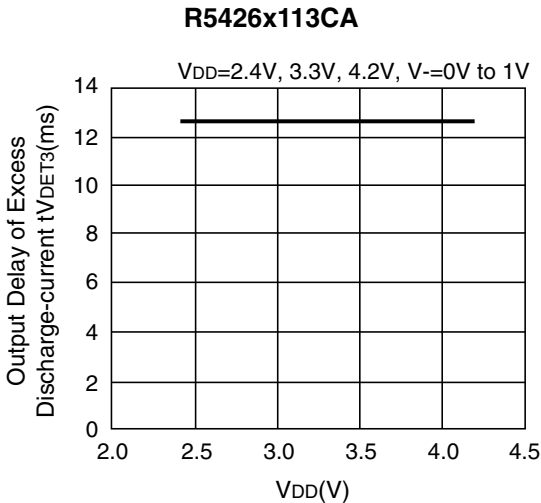

6) Output Delay for Release from Excess Discharge Current Detect vs. V_{DD}

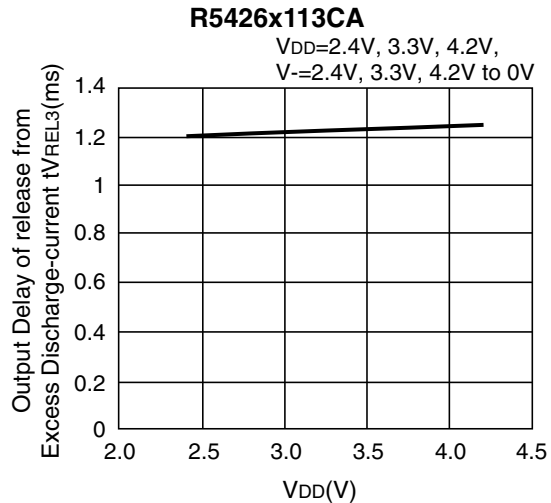

7) Delay Time for Excess Charge Current Detect vs. V_{DD}

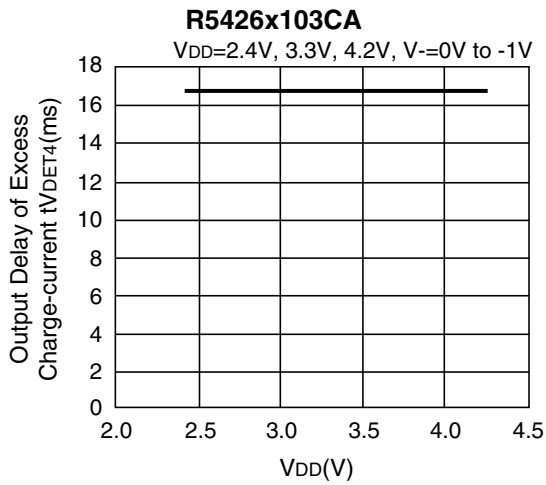

8) Delay Time for release from Excess charge current detect vs. V_{DD}

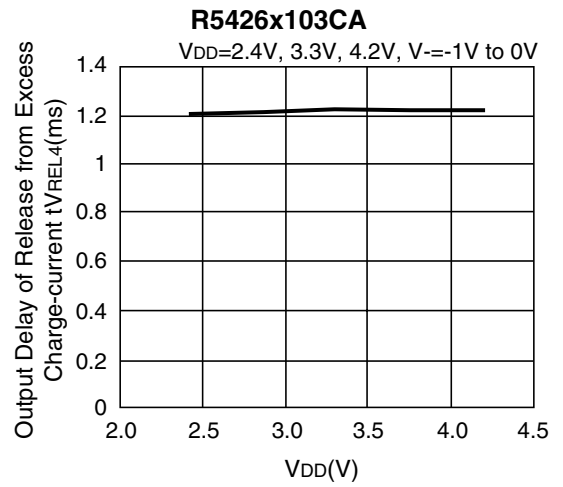

9) Output Delay for Short vs. V_{DD}

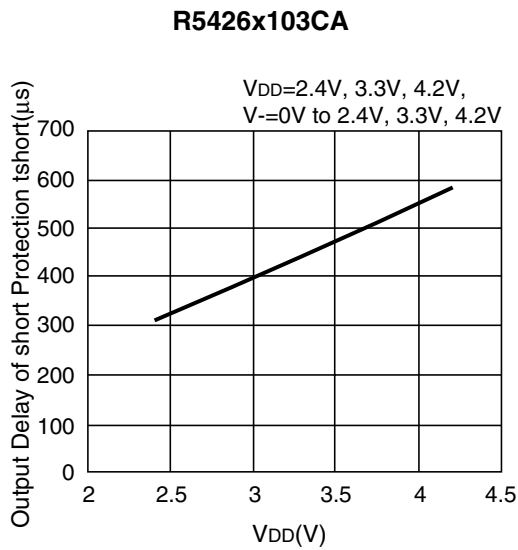

Part 3 Supply Current dependence on V_{DD}

Test Circuit

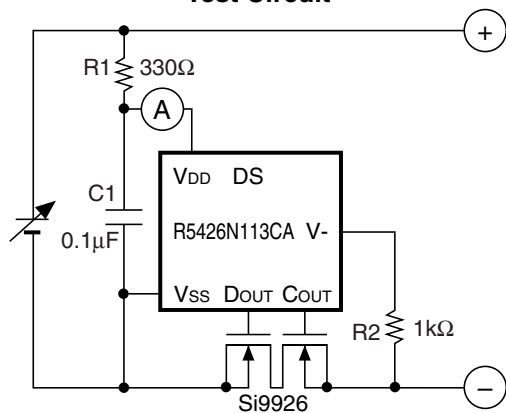

Supply Current vs. V_{DD}

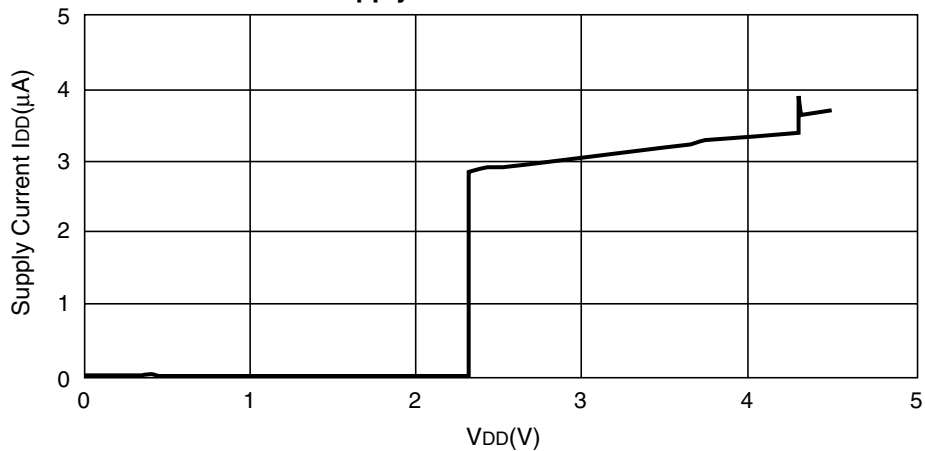

Part 4 Over-charge detector, Release voltage from Over-charge, Over-discharge detector, Release voltage from Over-discharge dependence on External Resistance value

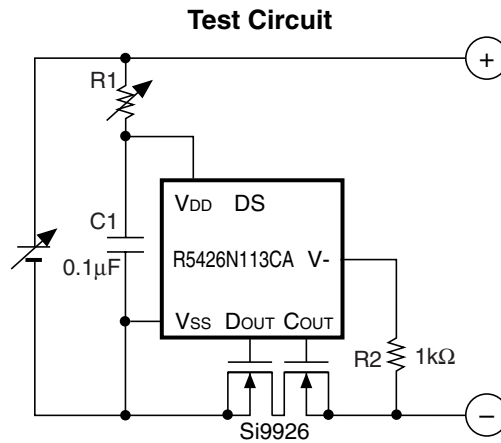

Over-discharge Detector Threshold / Released Voltage from Over-discharge vs. R1

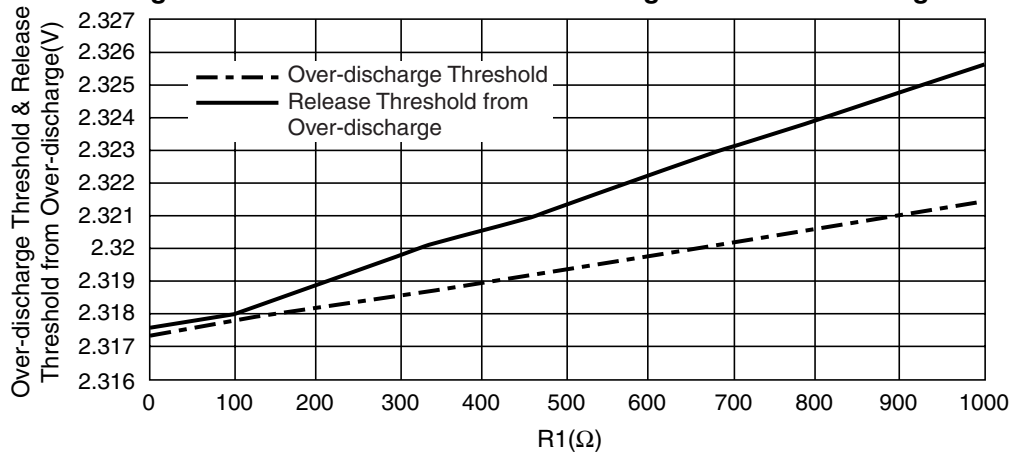

Over-charge / Released from Over-charge Threshold vs. R1

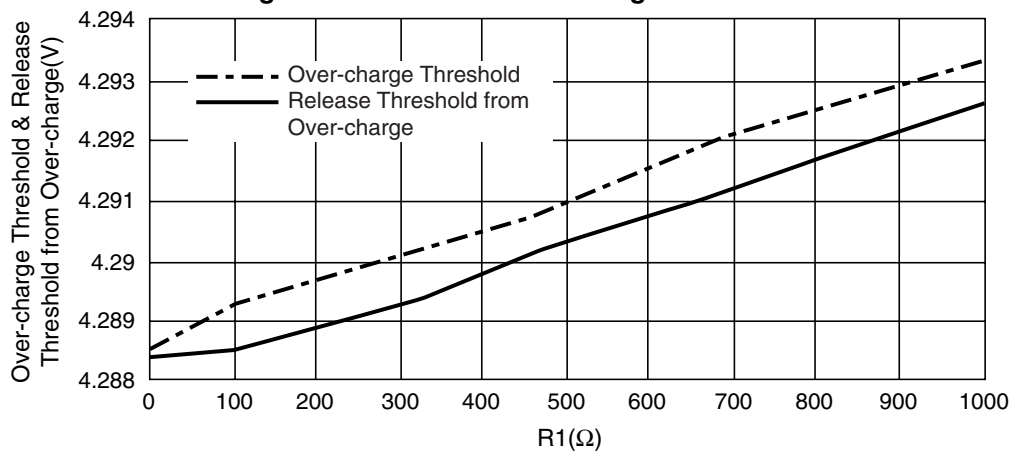

Part 5 Charger Voltage at Released from Over-discharge with a Charger dependence on R2

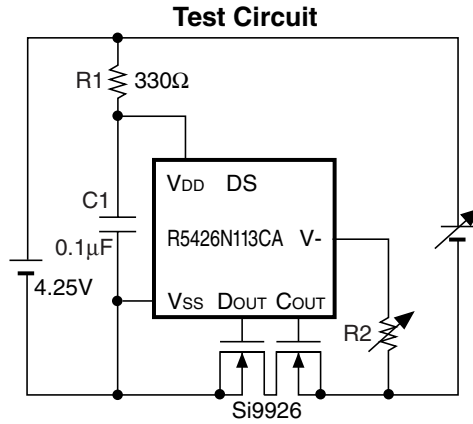

Charger Voltage at Release from Over-discharge with a charger vs. R2

V_{DD}=4.25V

