

LOW NOISE 150mA LDO REGULATOR R1121N SERIES

■ OUTLINE

The R1121N Series are voltage regulator ICs with high output voltage accuracy, extremely low supply current, low ON-resistance and high ripple rejection by CMOS process. Each of these voltage regulator ICs consists of a voltage reference unit, an error amplifier, resistors, a current limit circuit, and a chip enable circuit. These ICs perform with low dropout voltage and a chip enable function.

The line transient response and load transient response of the R1121N Series are excellent, thus these ICs are very suitable for the power supply for hand-held communication equipment.

The output voltage of these ICs is fixed with high accuracy.

Since the package for these ICs are SOT-23-5 (Mini-mold) package, high density mounting of the ICs on boards is possible.

■ FEATURES

- Ultra-Low Supply Current.....TYP. 35 μ A
- Standby ModeTYP. 0.1 μ A
- Low Dropout VoltageTYP. 0.2V ($I_{OUT} = 100\text{mA}$)
- High Ripple RejectionTYP. 70db ($f = 1\text{kHz}$)
- Low Temperature-Drift Coefficient of Output VoltageTYP. $\pm 100\text{ppm}/^\circ\text{C}$
- Excellent Line RegulationTYP. 0.05%/V
- High Accuracy Output Voltage..... $\pm 2.0\%$
- Small PackageSOT-23-5 (Mini-mold)
- Output VoltageStepwise setting with a step of 0.1V in the range of 1.5V to 5.0V is possible.
- Built-in chip enable circuit (2 Types; A: active "L", B: active "H")
- PinoutSimilar to the TK112, TK111

■ APPLICATIONS

- Power source for cellular phones such as GSM, CDMA and various kind of PCSs.
- Power source for domestic appliances such as cameras, VCRs and camcorders.
- Power source for battery-powered equipment.

■ BLOCK DIAGRAM

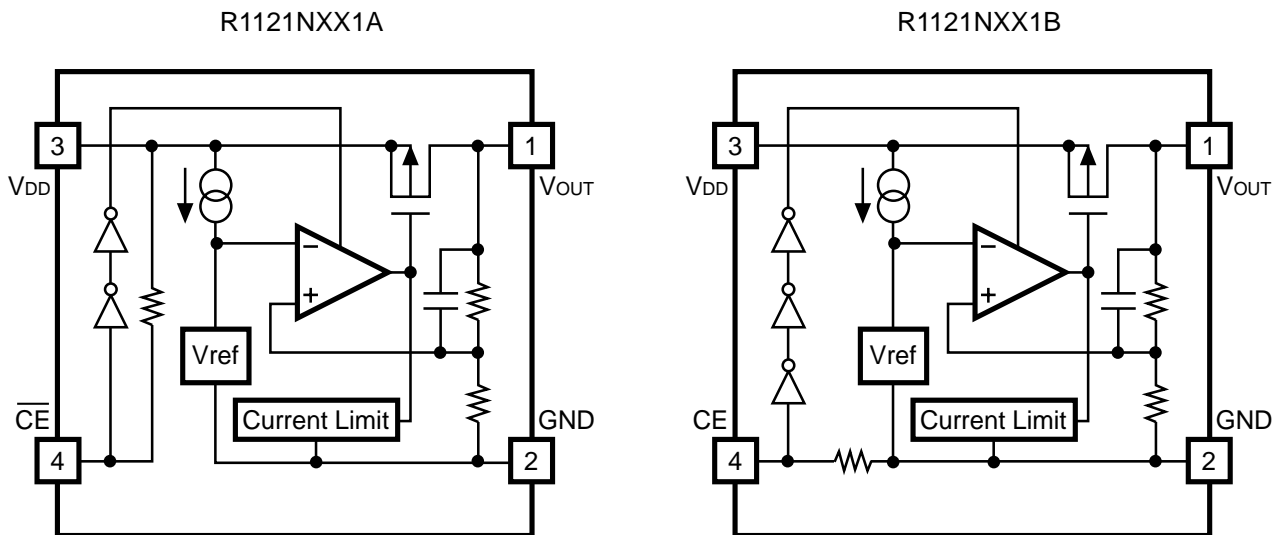

SELECTION GUIDE

The output voltage, the active type, the packing type, and the taping type for the ICs can be selected at the user's request. The selection can be made by designating the part number as shown below :

R1121XXX1X-XX ←Part Number
 ↑ ↑ ↑
 a b c

| Code | Contents |
|------|--|
| a | Setting Output Voltage (V_{OUT}) : Stepwise setting with a step of 0.1V in the range of 1.5V to 5.0V is possible. |
| b | Designation of Active Type : A : active "L" type B : active "H" type |
| c | Designation of Taping Type : Ex. TR, TL (refer to Taping Specifications; TR type is the standard direction.) |

PIN CONFIGURATION

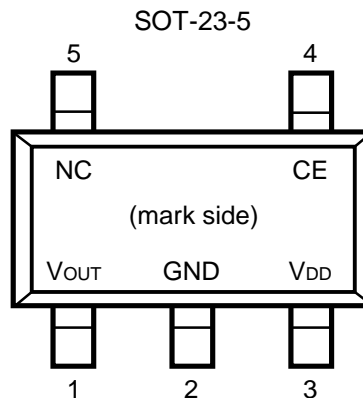

PIN DESCRIPTION

| Pin No. | Symbol | Description |
|---------|-----------------------|-----------------|
| 1 | V_{OUT} | Output pin |
| 2 | GND | Ground Pin |
| 3 | V_{DD} | Input Pin |
| 4 | \overline{CE} or CE | Chip Enable Pin |
| 5 | NC | No Connection |

■ ABSOLUTE MAXIMUM RATINGS

| Symbol | Item | Rating | Unit |
|------------------|------------------------------|-----------------------------|------|
| V _{IN} | Input Voltage | 9 | V |
| V _{CE} | Input Voltage (CE or CE Pin) | -0.3 ~ V _{IN} +0.3 | V |
| V _{OUT} | Output Voltage | -0.3 ~ V _{IN} +0.3 | V |
| P _D | Power Dissipation | 250 | mW |
| T _{opt} | Operating Temperature Range | -40 ~ 85 | °C |
| T _{stg} | Storage Temperature Range | -55 ~ 125 | °C |

■ ELECTRICAL CHARACTERISTICS

● R1121NXX1A

T_{opt} = 25°C

| Symbol | Item | Conditions | MIN. | TYP. | MAX. | Unit |
|--------------------------------------|--|--|---------------------------|------|---------------------------|---------|
| V _{OUT} | Output Voltage | V _{IN} = Set V _{OUT} +1V 1mA ≤ I _{OUT} ≤ 30mA | V _{OUT} ×0.98 | | V _{OUT} ×1.02 | V |
| I _{OUT} | Output Current | refer to the ELECTRICAL CHARACTERISTICS by OUTPUT VOLTAGE | | | | |
| ΔV _{OUT} /ΔI _{OUT} | Load Regulation | V _{IN} = Set V _{OUT} +1V 1mA ≤ I _{OUT} ≤ 80mA | | 12 | 40 | mV |
| V _{DIF} | Dropout Voltage | refer to the ELECTRICAL CHARACTERISTICS by OUTPUT VOLTAGE | | | | |
| I _{SS} | Supply Current | V _{IN} = Set V _{OUT} +1V | | 35 | 70 | μA |
| I _{standby} | Supply Current (Standby) | V _{IN} = V _{CE} = Set V _{OUT} +1V | | 0.1 | 1.0 | μA |
| ΔV _{OUT} /ΔV _{IN} | Line Regulation | Set V _{OUT} +0.5V ≤ V _{IN} ≤ 8V I _{OUT} = 30mA | | 0.05 | 0.20 | %/V |
| RR | Ripple Rejection | f = 1KHz, Ripple 0.5Vp-p V _{IN} = Set V _{OUT} +1V | | 70 | | dB |
| V _{IN} | Input Voltage | | | | 8 | V |
| ΔV _{OUT} /ΔT | Output Voltage Temperature Coefficient | I _{OUT} = 30mA -40°C ≤ T _{opt} ≤ 85°C | | ±100 | | ppm /°C |
| I _{lim} | Short Current Limit | V _{OUT} = 0V | | 50 | | mA |
| R _{PU} | CE Pull-up Resistance | | 2.5 | 5 | 10 | MΩ |
| V _{CEH} | CE Input Voltage "H" | | 1.5 | | V _{IN} | V |
| V _{CEL} | CE Input Voltage "L" | | 0 | | 0.25 | V |
| en | Output Noise | BW = 10Hz ~ 100kHz | | 30 | | μVrms |

● R1121NXX1B

Topt=25°C

| Symbol | Item | Conditions | MIN. | TYP. | MAX. | Unit |
|--------------------------------------|--|--|---------------------------|------|---------------------------|--------|
| V _{OUT} | Output Voltage | V _{IN} = Set V _{OUT} +1V 1mA ≤ I _{OUT} ≤ 30mA | V _{OUT} ×0.98 | | V _{OUT} ×1.02 | V |
| I _{OUT} | Output Current | refer to the ELECTRICAL CHARACTERISTICS by OUTPUT VOLTAGE | | | | |
| ΔV _{OUT} /ΔI _{OUT} | Load Regulation | V _{IN} = Set V _{OUT} +1V 1mA ≤ I _{OUT} ≤ 80mA | | 12 | 40 | mV |
| V _{DIF} | Dropout Voltage | refer to the ELECTRICAL CHARACTERISTICS by OUTPUT VOLTAGE | | | | |
| I _{SS} | Supply Current | V _{IN} = Set V _{OUT} +1V | | 35 | 70 | μA |
| I _{standby} | Supply Current (Standby) | V _{IN} = Set V _{OUT} +1V V _{CE} = GND | | 0.1 | 1.0 | μA |
| ΔV _{OUT} /ΔV _{IN} | Line Regulation | Set V _{OUT} +0.5V ≤ V _{IN} ≤ 8V I _{OUT} = 30mA | | 0.05 | 0.20 | %/V |
| RR | Ripple Rejection | f = 1KHz, Ripple 0.5Vp-p V _{IN} = Set V _{OUT} +1V | | 70 | | dB |
| V _{IN} | Input Voltage | | | | 8 | V |
| ΔV _{OUT} /ΔT | Output Voltage Temperature Coefficient | I _{OUT} = 30mA -40°C ≤ Topt ≤ 85°C | | ±100 | | ppm/°C |
| I _{lim} | Short Current Limit | V _{OUT} = 0V | | 50 | | mA |
| R _{PD} | CE Pull-down Resistance | | 2.5 | 5 | 10 | MΩ |
| V _{CEH} | CE Input Voltage "H" | | 1.5 | | V _{IN} | V |
| V _{CEL} | CE Input Voltage "L" | | 0 | | 0.25 | V |
| en | Output Noise | BW = 10Hz ~ 100kHz | | 30 | | μVrms |

● ELECTRICAL CHARACTERISTICS by OUTPUT VOLTAGE

Topt = 25°C

| Output Voltage V _{OUT} (V) | Output Current | |
|--|---|------|
| | I _{OUT} (mA) | |
| | Conditions | MIN. |
| 1.5 ≤ V _{OUT} ≤ 1.7 | V _{IN} - V _{OUT} = 1.0V | 100 |
| 1.8 ≤ V _{OUT} ≤ 5.0 | | 150 |

Topt = 25°C

| Output Voltage V _{OUT} (V) | Dropout Voltage | | | |
|--|--------------------------|------|------|------|
| | V _{DIF} (V) | | | |
| | Conditions | MIN. | TYP. | MAX. |
| 1.5 | I _{OUT} = 100mA | 0.5 | | |
| 1.6 | | 0.4 | | |
| 1.7 | | 0.3 | | |
| 1.8 ≤ V _{OUT} ≤ 1.9 | | | 0.60 | 1.40 |
| 2.0 ≤ V _{OUT} ≤ 2.4 | | | 0.35 | 0.70 |
| 2.5 ≤ V _{OUT} ≤ 2.7 | | | 0.24 | 0.35 |
| 2.8 ≤ V _{OUT} ≤ 3.3 | | | 0.20 | 0.30 |
| 3.4 ≤ V _{OUT} ≤ 5.0 | | | 0.17 | 0.26 |

Note : When set Output Voltage is equal or less than 2.0V, V_{IN} should be equal or more than 2.0V.

■ OPERATION

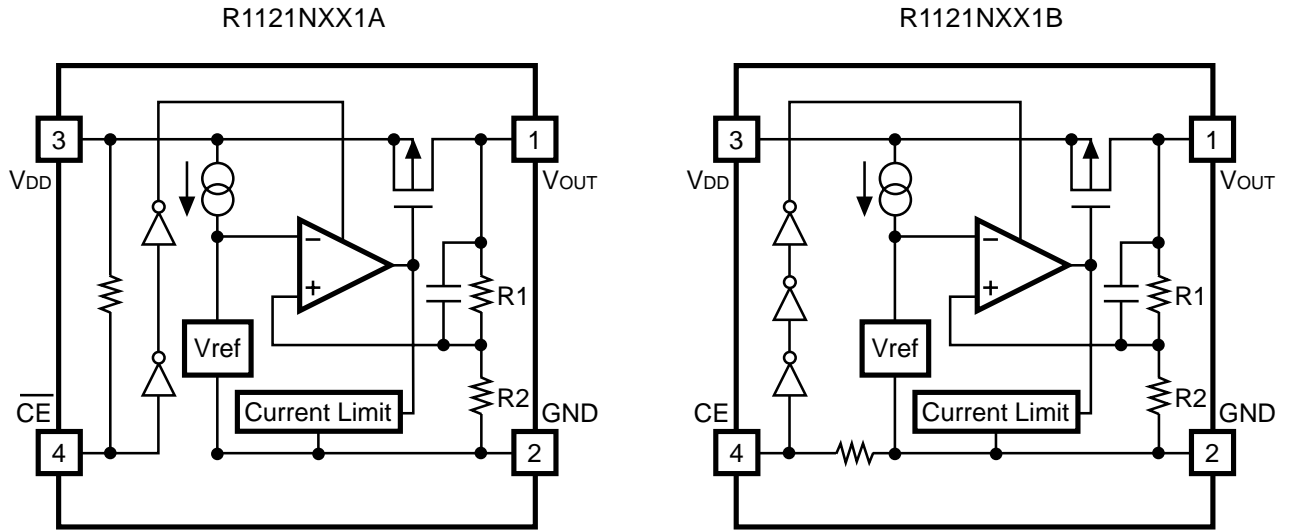

In these ICs, fluctuation of Output Voltage, V_{OUT} is detected by Feed-back Registers, R1 and R2, and the result is compared with a reference voltage by Error Amplifier, so that a constant voltage is output. A current limit circuit for protection at short mode and a chip enable circuit are included.

TEST CIRCUITS

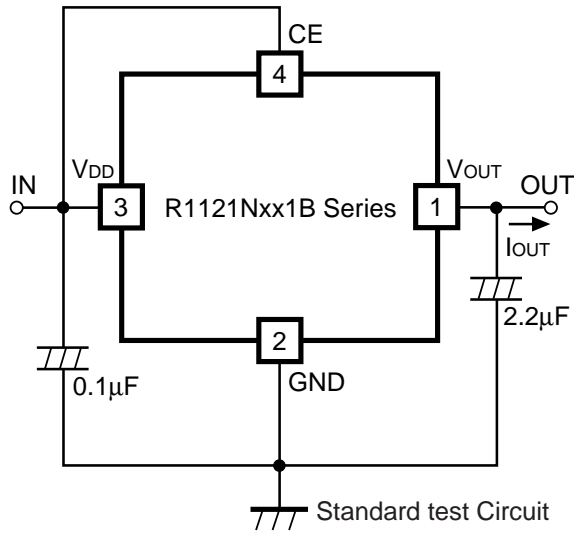

Fig.1 Standard test Circuit

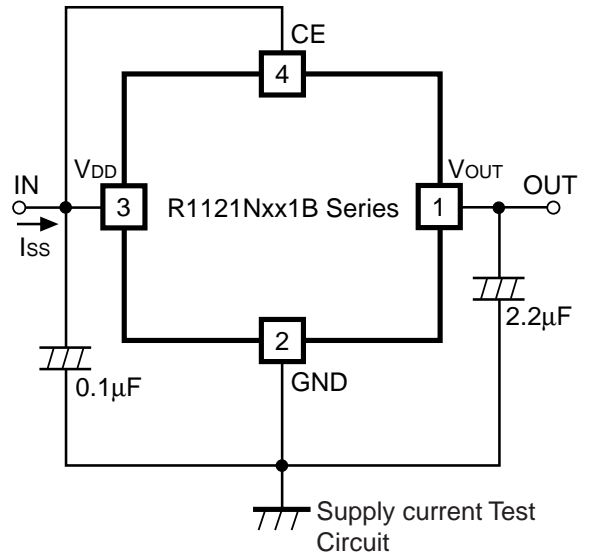

Fig.2 Supply Current Test Circuit

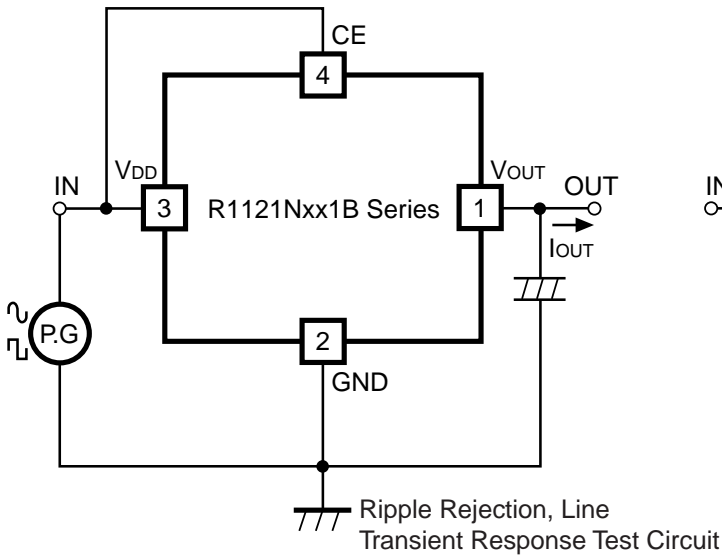

Fig.3 Ripple Rejection, Line Transient Response Test Circuit

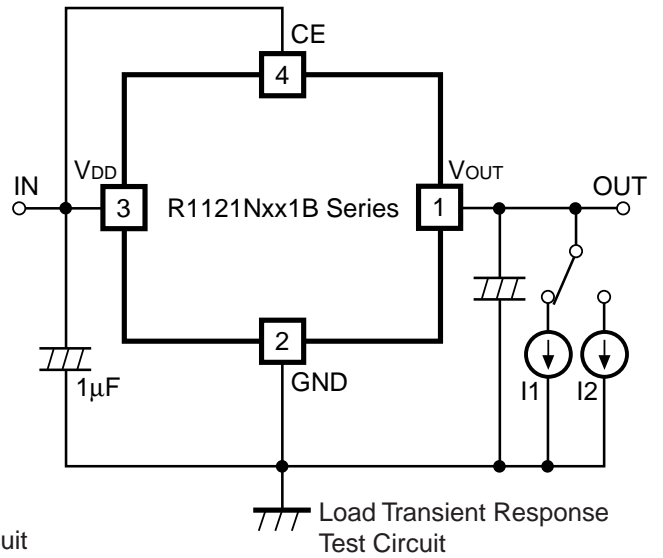
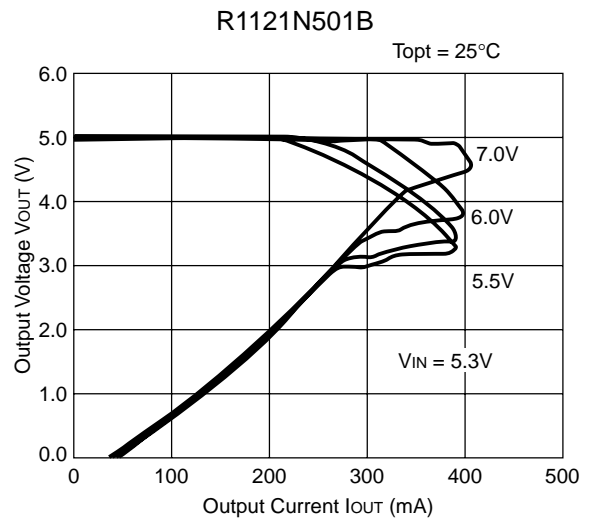
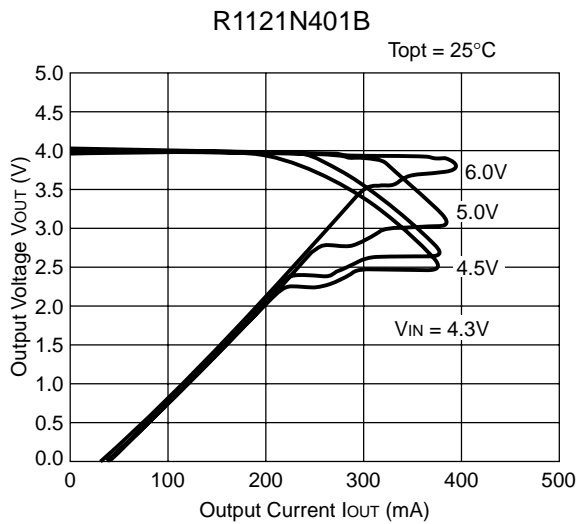
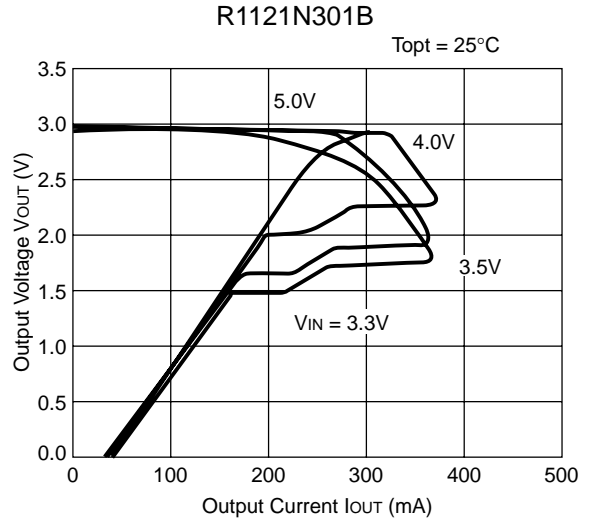
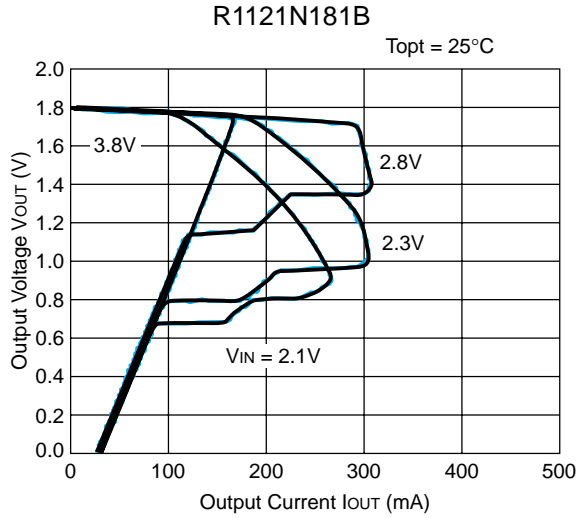

Fig.4 Load Transient Response Test Circuit

TYPICAL CHARACTERISTICS

1) Output Voltage vs. Output Current



2) Output Voltage vs. Input Voltage

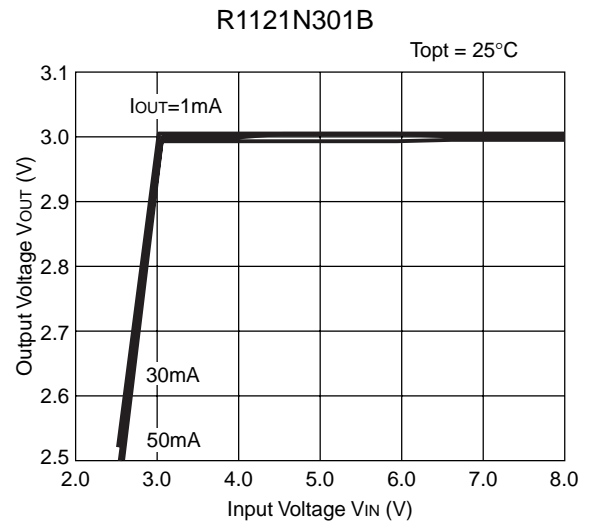
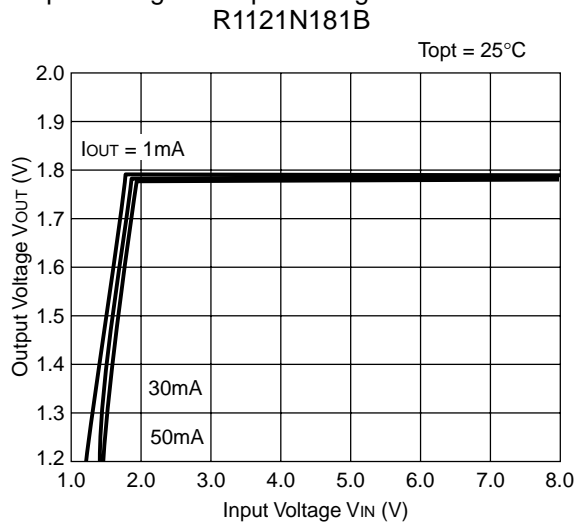

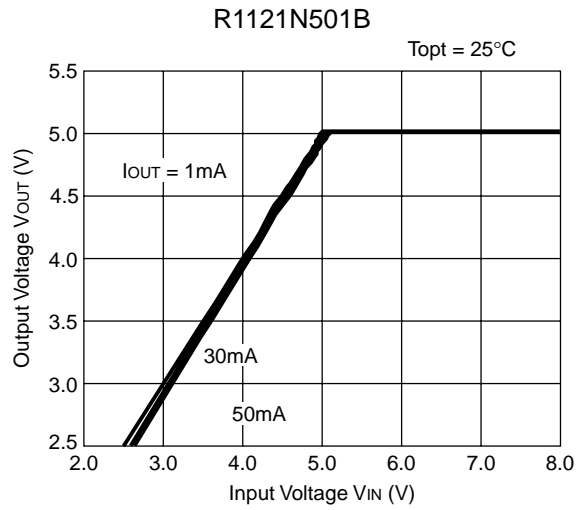
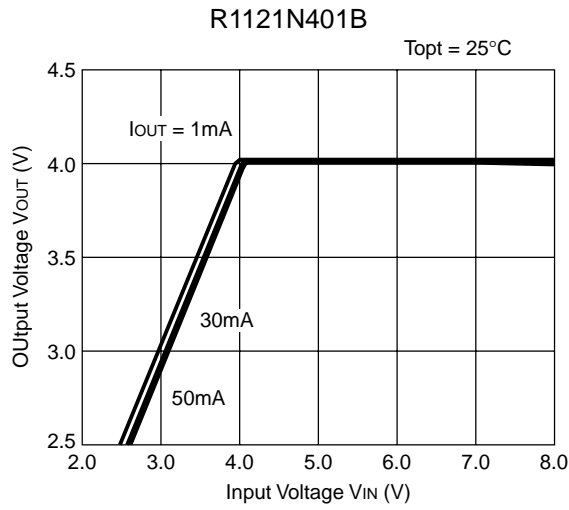

3) Dropout Voltage vs. Output Current
R1121N181B

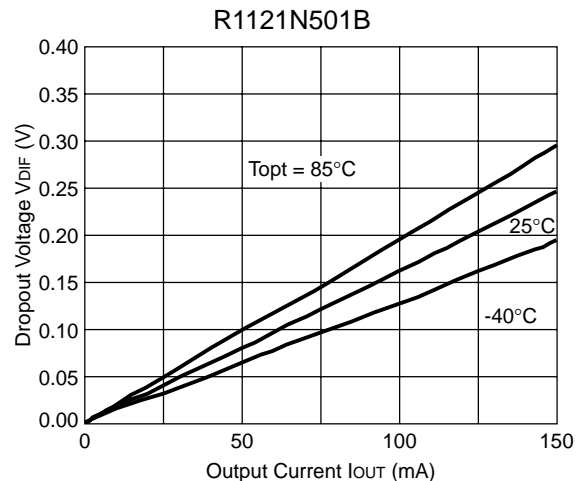
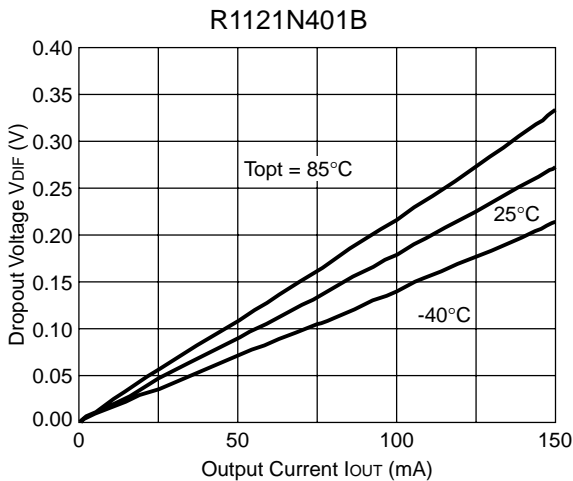
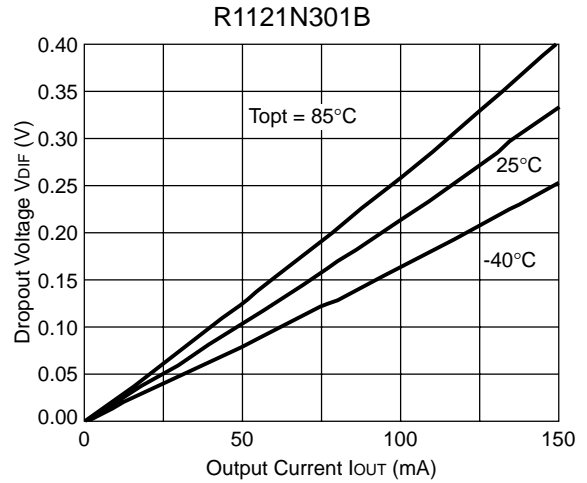
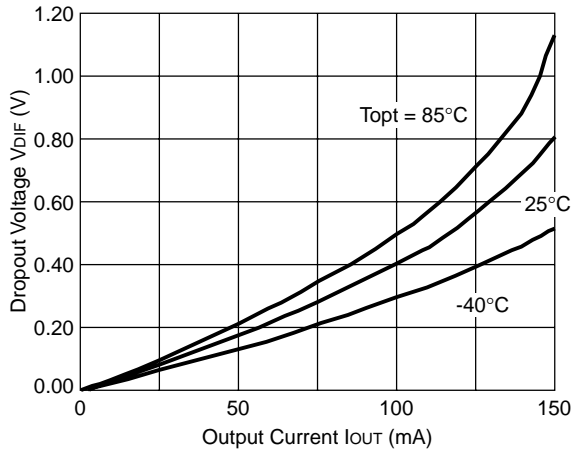

4) Output Voltage vs. Temperature
R1121N181B

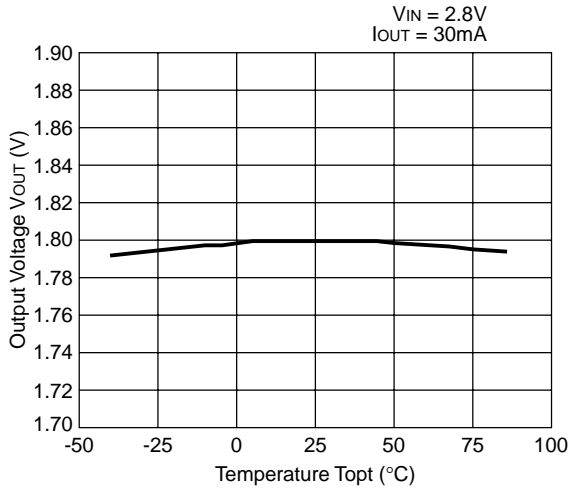

R1121N301B
 $V_{IN} = 4.0V$
 $I_{OUT} = 30mA$

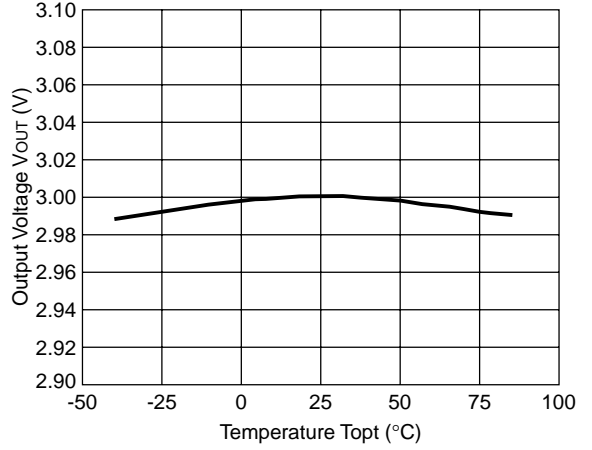

R1121N401B
 $V_{IN} = 5.0V$
 $I_{OUT} = 30mA$

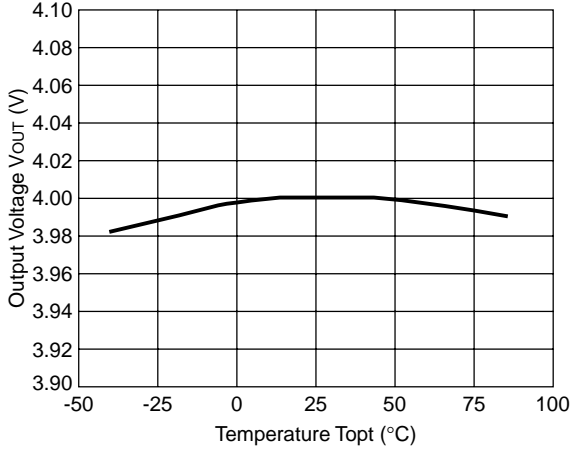

R1121N501B
 $V_{IN} = 6.0V$
 $I_{OUT} = 30mA$

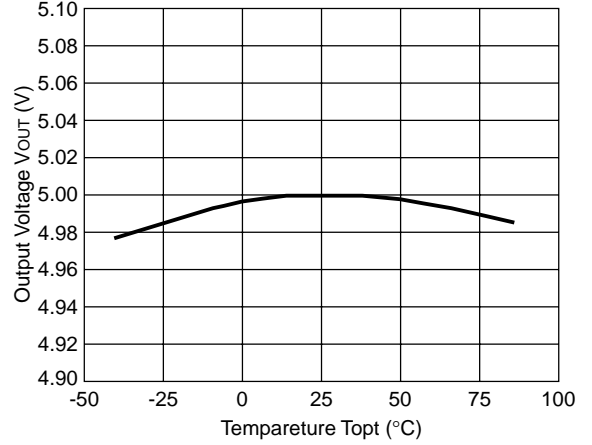

5) Supply Current vs. Input Voltage
R1121N181B

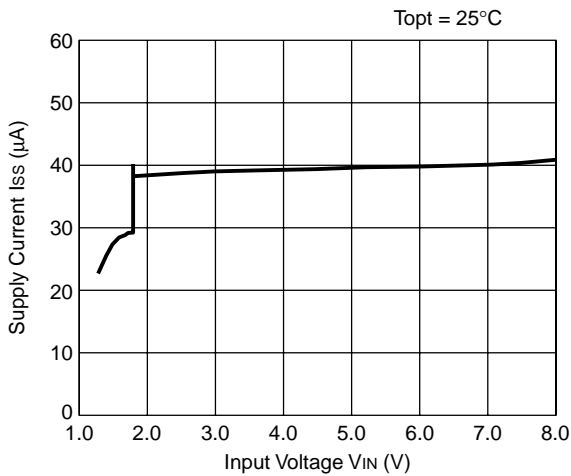

R1121N301B
 $T_{opt} = 25^{\circ}C$

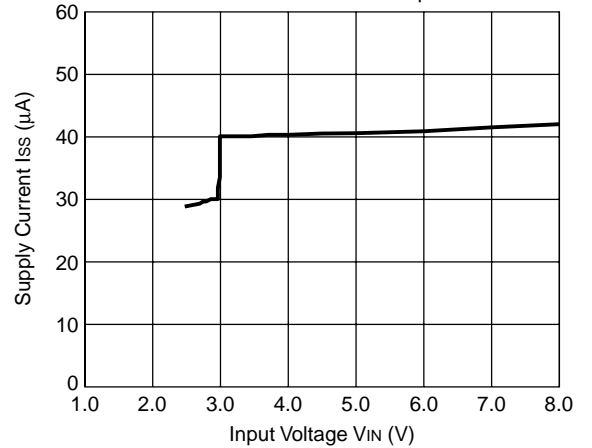

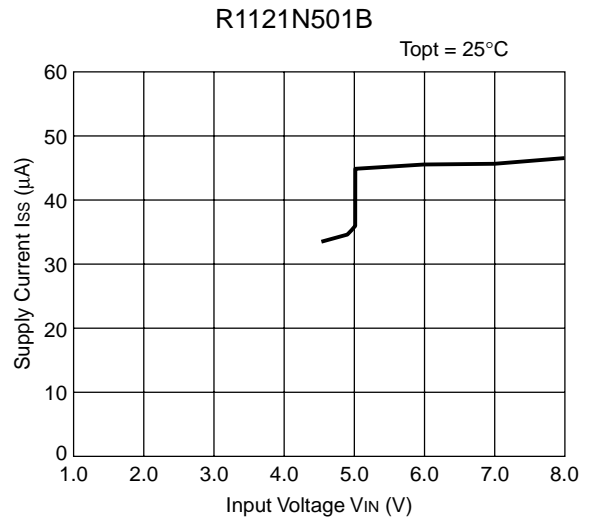
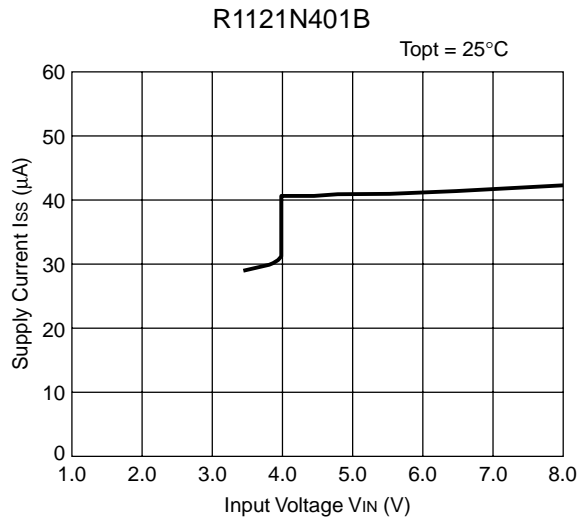

6) Supply Current vs. Temperature

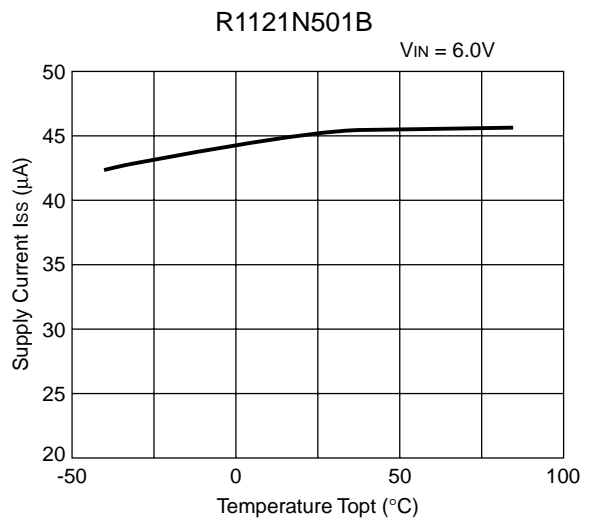
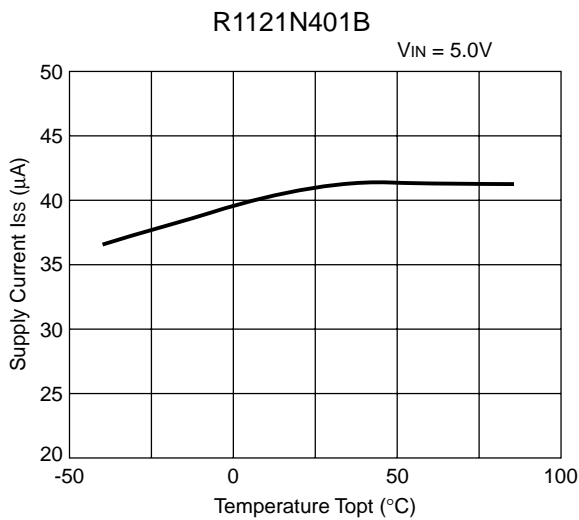
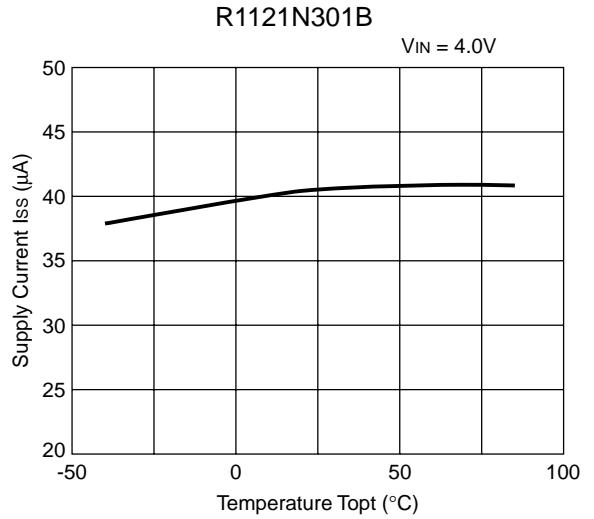
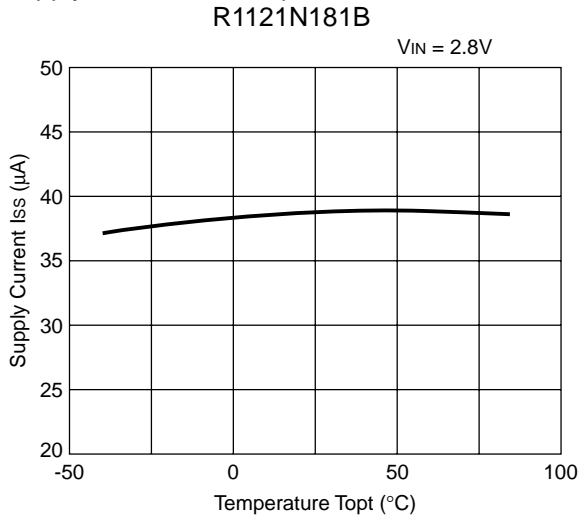

7) Dropout Voltage vs. Set Output Voltage
R1121Nxx1B

Topt = 25°C

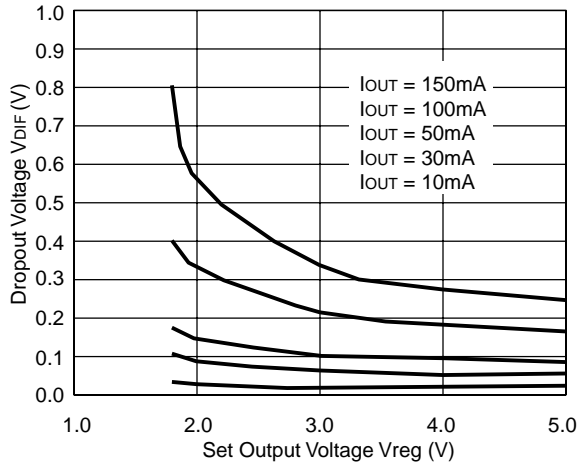

8) Ripple Rejection vs. Frequency
R1121N181B

VIN = 2.8VDC + 0.5Vp-p
COUT = tantal 1.0μF

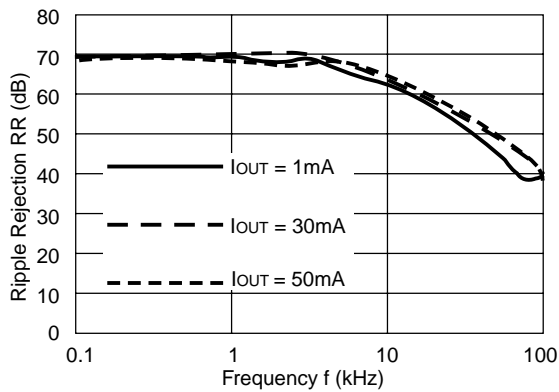

R1121N181B

VIN = 2.8VDC + 0.5Vp-p
COUT = tantal 2.2μF

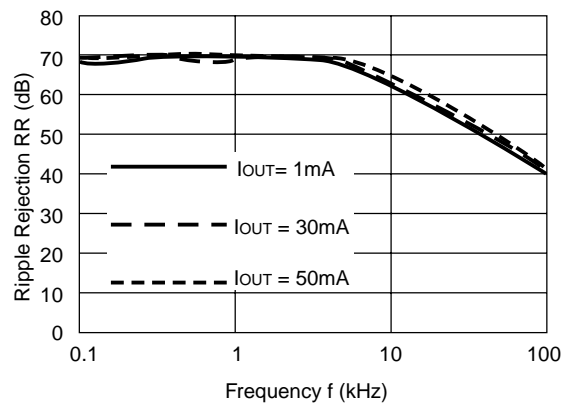

R1121N301B

VIN = 4.0VDC + 0.5Vp-p
COUT = tantal 1.0μF

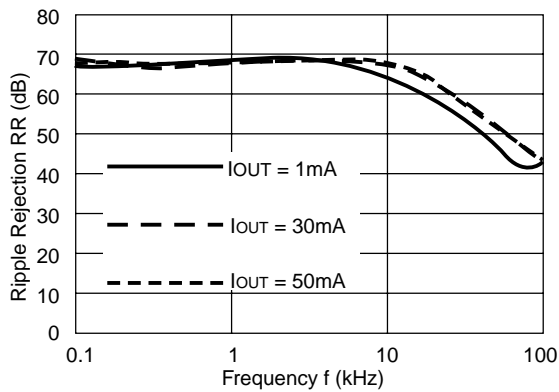

R1121N301B

VIN = 4.0VDC + 0.5Vp-p
COUT = tantal 2.2μF

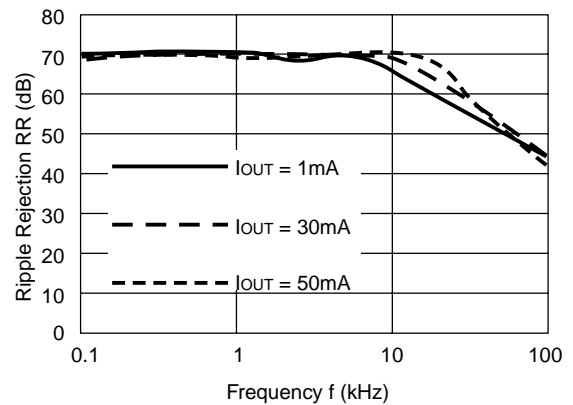

R1121N401B

$V_{IN} = 5.0V_{DC} + 0.5V_{p-p}$
 $C_{OUT} = \text{tantal } 1.0\mu F$

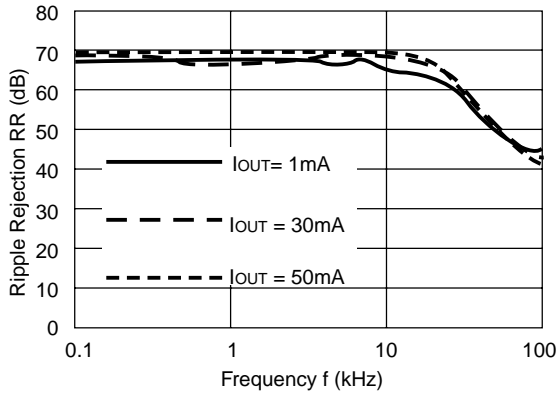

R1121N401B

$V_{IN} = 5.0V_{DC} + 0.5V_{p-p}$
 $C_{OUT} = \text{tantal } 2.2\mu F$

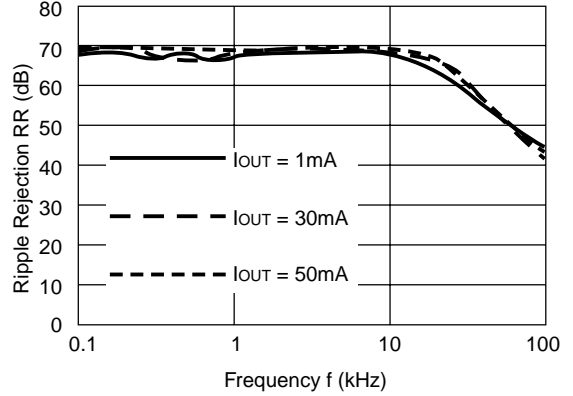

9) Ripple Rejection vs. Input Voltage (DC bias)

R1121N301B

$I_{OUT} = 1mA$
 $C_{OUT} = 2.2\mu F$

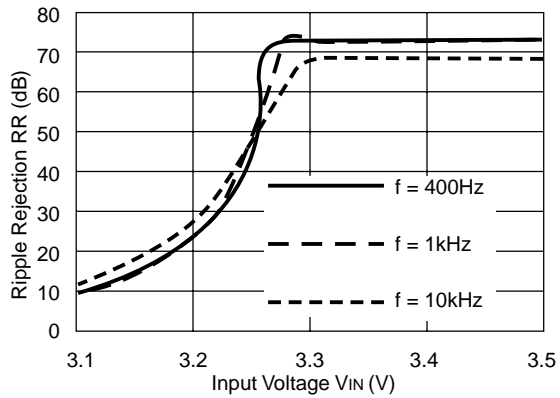

R1121N301B

$I_{OUT} = 10mA$
 $C_{OUT} = 2.2\mu F$

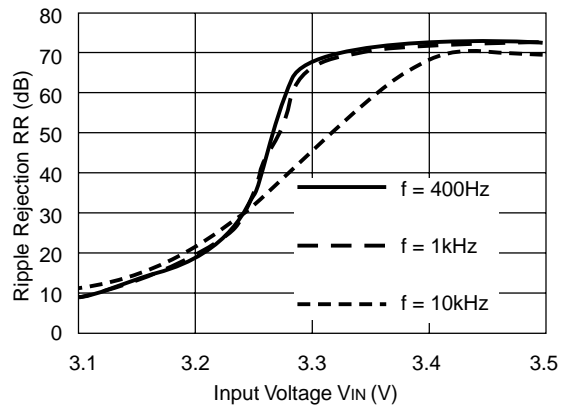

R1121N301B

$I_{OUT} = 50mA$
 $C_{OUT} = 2.2\mu F$

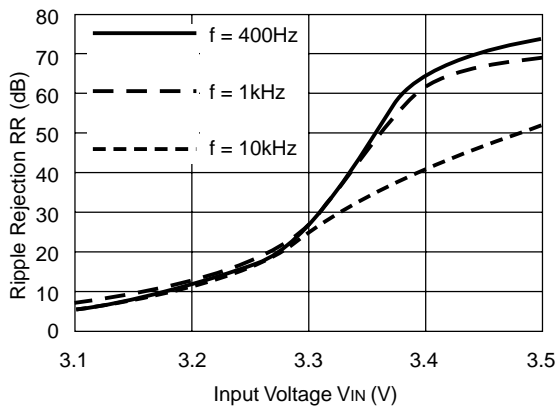

10) Line Transient Response

R1121N301B

$I_{OUT}=30\text{mA}$
 $t_r=t_f=5\ \mu\text{s}$
 $C_{OUT}=\text{Tantalum } 1.0\ \mu\text{F}$

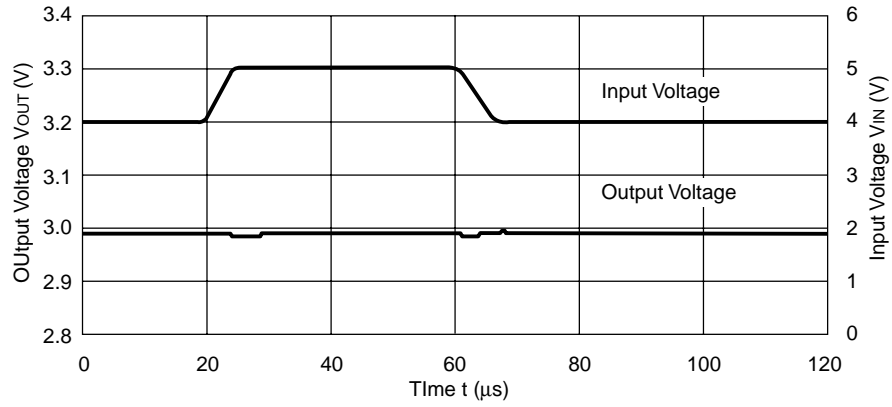

R1121N301B

$I_{OUT}=30\text{mA}$
 $t_r=t_f=5\ \mu\text{s}$
 $C_{OUT}=\text{Tantalum } 2.2\ \mu\text{F}$

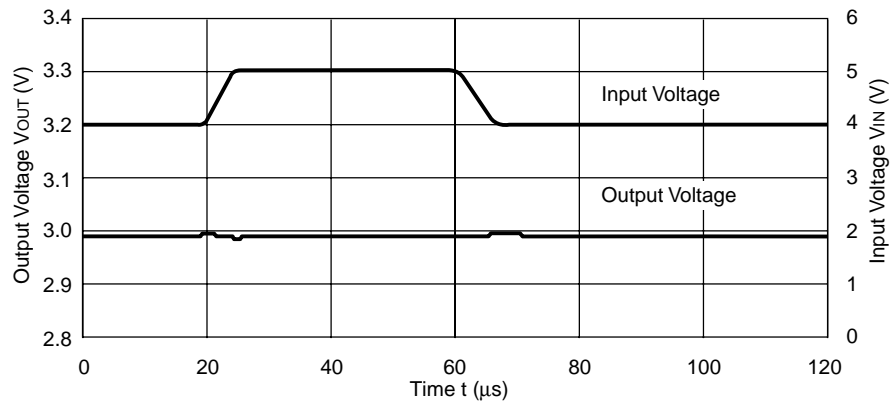

R1121N301B

$I_{OUT}=30\text{mA}$
 $t_r=t_f=5\ \mu\text{s}$
 $C_{OUT}=\text{Tantalum } 6.8\ \mu\text{F}$

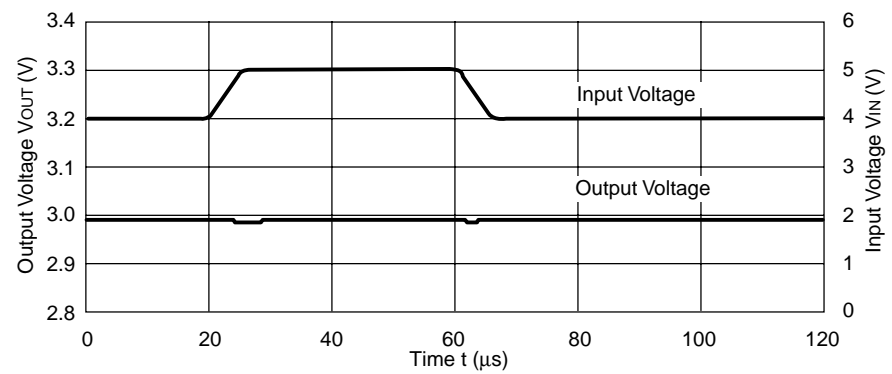

11) Load Transient Response

R1121N301B

$V_{IN}=4V$
 $C_{IN}=\text{Tantalum } 1\mu F$
 $C_{OUT}=\text{Tantalum } 1.0\mu F$

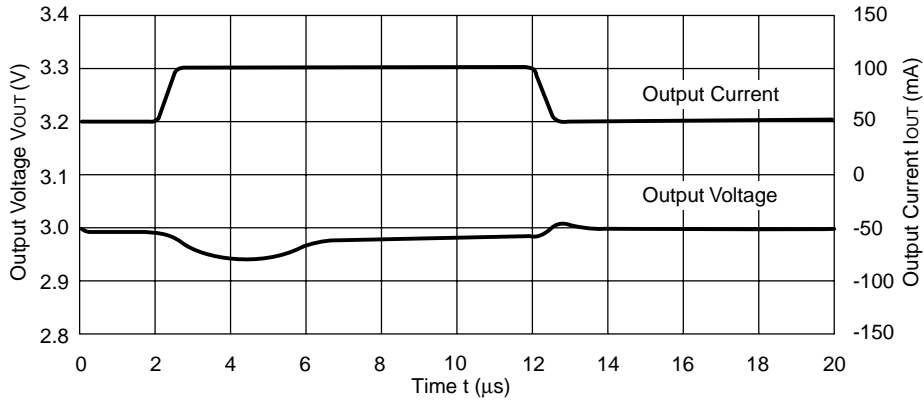

R1121N301B

$V_{IN}=4V$
 $C_{IN}=\text{Tantalum } 1\mu F$
 $C_{OUT}=\text{Tantalum } 2.2\mu F$

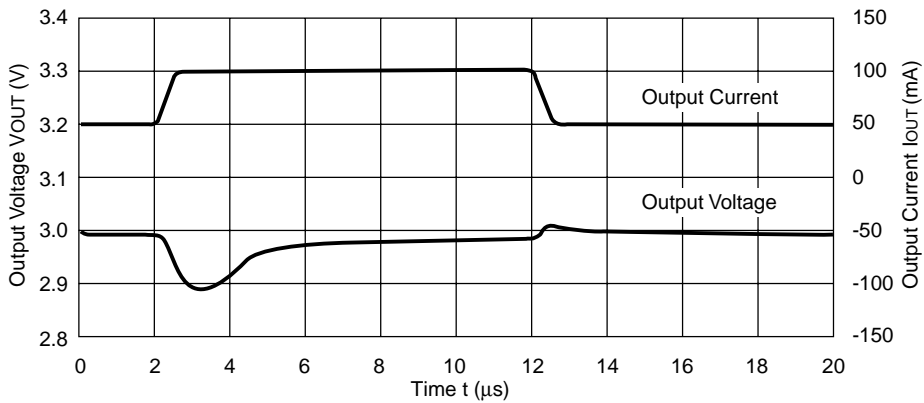

R1121N301B

$V_{IN}=4V$
 $C_{IN}=\text{Tantalum } 1\mu F$
 $C_{OUT}=\text{Tantalum } 6.8\mu F$

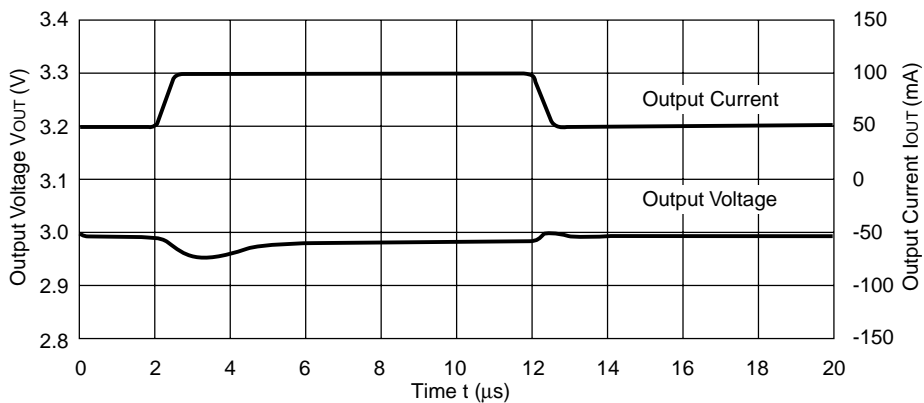

TECHNICAL NOTES

When using these ICs, be sure to consider following points:

- In these ICs, phase compensation is made for securing stable operation even if the load current is varied. For this purpose, be sure to use a capacitor C_{OUT} with good frequency characteristics and ESR (Equivalent Series Resistance) of which is in the range described as follows:

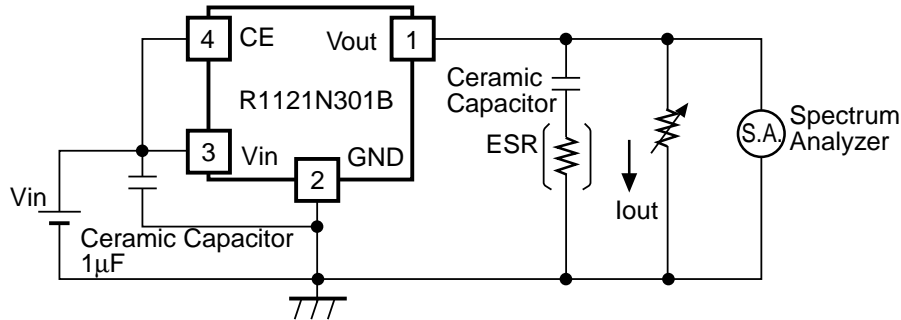

Measuring Circuit for white noise ; R1121N301B

The relations between I_{OUT} (Output Current) and ESR of Output Capacitor are shown below. The conditions when the white noise level is under $40\mu\text{V}$ (Avg.) are marked as the hatched area in the graph.
(note: When the additional ceramic capacitors are connected to the Output Pin with Output capacitor for phase compensation, the operation might be unstable. Because of this, test these ICs with as same external components as ones to be used on the PCB.)

<measuring conditions>

- $V_{IN} = 4\text{V}$
- Frequency band : 10Hz to 1MHz
- Temperature : 25°C

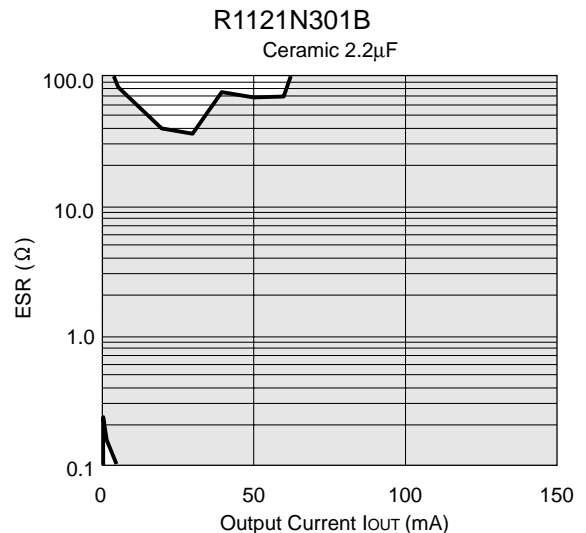
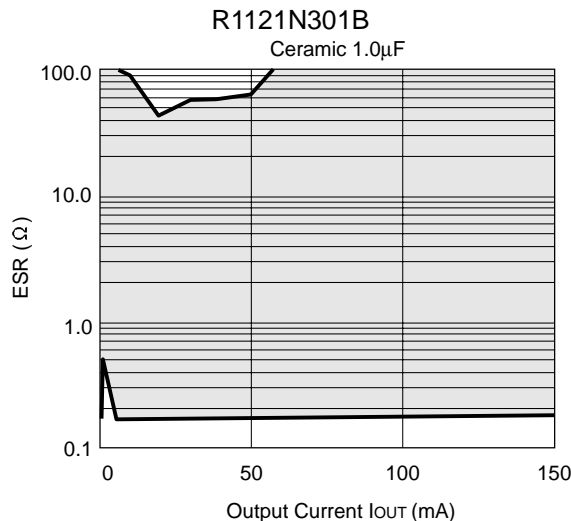

- Make V_{DD} and GND line sufficient. When the impedance of these is high, there is a case to pick up the noise or not to work correctly.
- Connect the capacitor with a capacitance of $1\mu\text{F}$ or more between V_{DD} and GND as close as possible.
- Set external components, especially Output Capacitor, as close as possible to the ICs and make wiring shortest.

■ TYPICAL APPLICATION

