

# Small switching (30V, 0.1A)

## UM6K1N

●Features

- 1) Two 2SK3018 transistors in a single UMT package.
- 2) The MOSFET elements are independent, eliminating interference.
- 3) Mounting cost and area can be cut in half.
- 4) Low on-resistance.
- 5) Low voltage drive (2.5V) makes this device ideal for portable equipment.

●Applications

Interfacing, switching (30V, 100mA)

●Structure

Silicon N-channel  
MOSFET

●External dimensions (Units: mm)

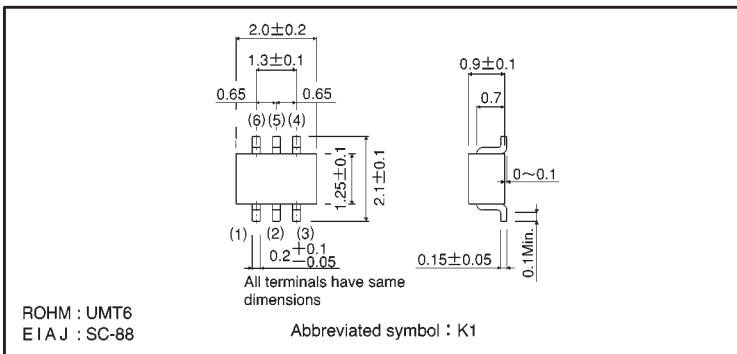

●Equivalent circuit

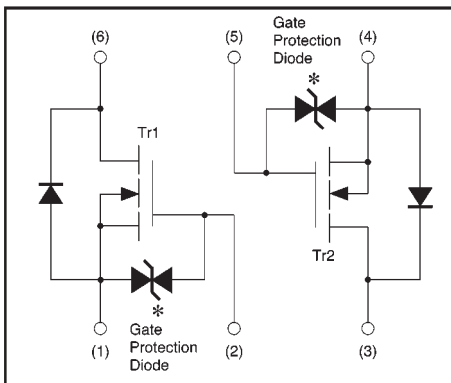

- (1) Tr1 Source
- (2) Tr1 Gate
- (3) Tr2 Drain
- (4) Tr2 Source
- (5) Tr2 Gate
- (6) Tr1 Drain

\* A protection diode has been built in between the gate and the source to protect against static electricity when the product is in use. Use the protection circuit when rated voltages are exceeded.

●Absolute maximum ratings (Ta = 25°C)

Parameter	Symbol	Limits	Unit
Drain-source voltage	V <sub>DSS</sub>	30	V
Gate-source voltage	V <sub>GSS</sub>	±20	V
Drain current	Continuous	I <sub>D</sub>	100 mA
	Pulsed	I <sub>DP</sub> *1	200 mA
Reverse drain current	Continuous	I <sub>DR</sub>	100 mA
	Pulsed	I <sub>DRP</sub> *1	200 mA
Total power dissipation (Tc=25°C)	P <sub>D</sub> *2	150	mW
Channel temperature	T <sub>ch</sub>	150	°C
Storage temperature	T <sub>stg</sub>	-55~+150	°C

\*1 Pw ≤ 10 μs, Duty cycle ≤ 50%

\*2 With each pin mounted on the recommended lands.

●Packaging specifications

Type	Package	Taping
	Code	TN
	Basic ordering unit (pieces)	3000
UM6K1N		○

●Electrical characteristics (Ta = 25°C)

Parameter	Symbol	Min.	Typ.	Max.	Unit	Test Conditions
Gate-source leakage	$I_{GSS}$	—	—	$\pm 1$	$\mu A$	$V_{GS} = \pm 20V, V_{DS} = 0V$
Drain-source breakdown voltage	$V_{(BR)DSS}$	30	—	—	V	$I_D = 10 \mu A, V_{GS} = 0V$
Zero gate voltage drain current	$I_{DSS}$	—	—	1.0	$\mu A$	$V_{DS} = 30V, V_{GS} = 0V$
Gate threshold voltage	$V_{GS(th)}$	0.8	—	1.5	V	$V_{DS} = 3V, I_D = 100 \mu A$
Static drain-source on-starte resistance	$R_{DS(on)}$	—	5	8	$\Omega$	$I_D = 10mA, V_{GS} = 4V$
	$R_{DS(on)}$	—	7	13	$\Omega$	$I_D = 1mA, V_{GS} = 2.5V$
Forward transfer admittance	$ Y_{fs} $	20	—	—	mS	$I_D = 10mA, V_{DS} = 3V$
Input capacitance	$C_{iss}$	—	13	—	pF	$V_{DS} = 5V$
Output capacitance	$C_{oss}$	—	9	—	pF	$V_{GS} = 0V$
Reverse transfer capacitance	$C_{rss}$	—	4	—	pF	$f = 1MHz$
Turn-on delay time	$t_{d(on)}$	—	15	—	ns	$I_D = 10mA, V_{DD} = 5V$
Rise time	$t_r$	—	35	—	ns	$V_{GS} = 5V$
Turn-off delay time	$t_{d(off)}$	—	80	—	ns	$R_L = 500 \Omega$
Fall time	$t_f$	—	80	—	ns	$R_{GS} = 10 \Omega$

●Electrical characteristic curves

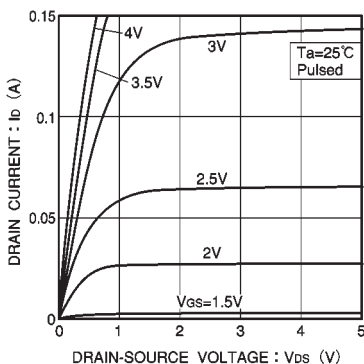

Fig.1 Typical output characteristics

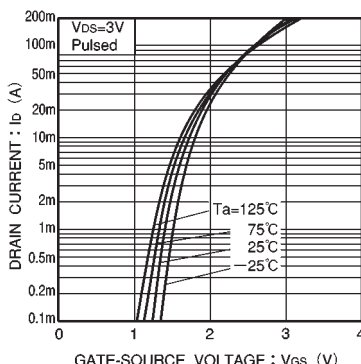

Fig.2 Typical transfer characteristics

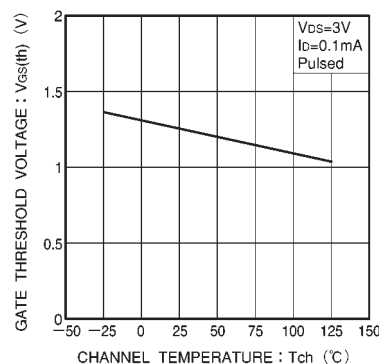

Fig.3 Gate threshold voltage vs. channel temperature

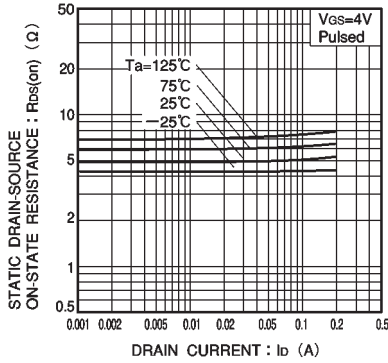

Fig. 4 Static drain-source on-state resistance vs. drain current ( I )

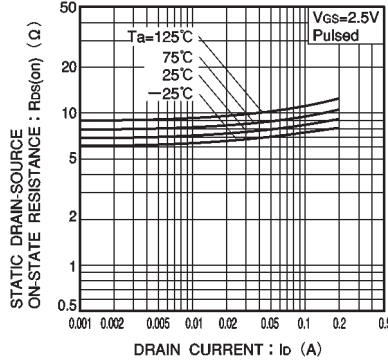

Fig. 5 Static drain-source on-state resistance vs. drain current ( II )

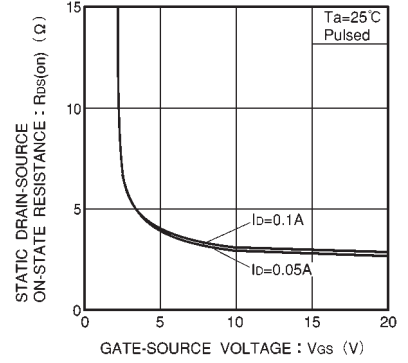

Fig. 6 Static drain-source on-state resistance vs. gate-source voltage

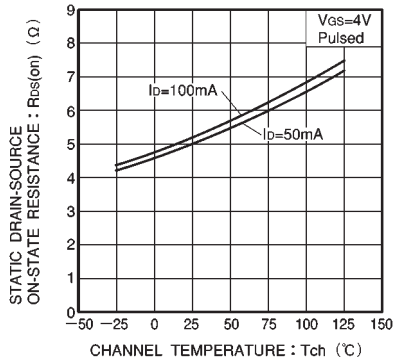

Fig. 7 Static drain-source on-state resistance vs. channel temperature

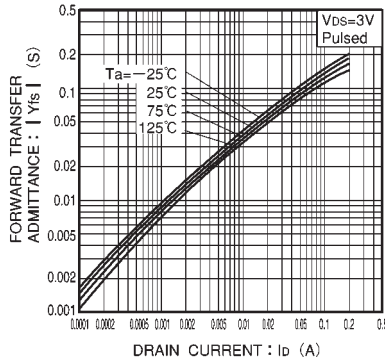

Fig. 8 Forward transfer admittance vs. drain current

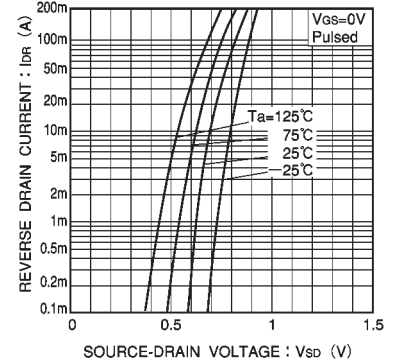

Fig. 9 Reverse drain current vs. source-drain voltage ( I )

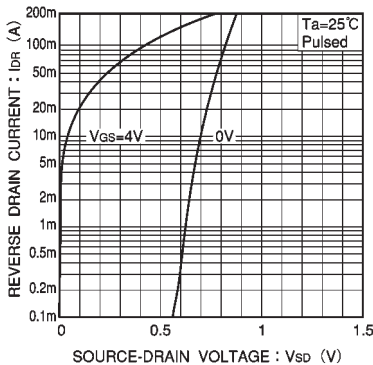

Fig. 10 Reverse drain current vs. source-drain voltage ( II )

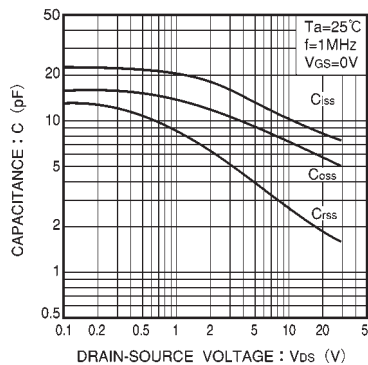

Fig. 11 Typical capacitance vs. drain-source voltage

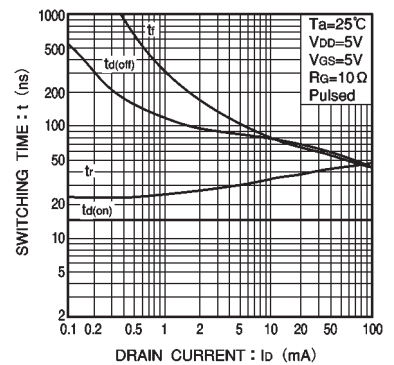

Fig. 12 Switching characteristics (See Figures 13 and 14 for the measurement circuit and resultant waveforms)

● Switching characteristics measurement circuit

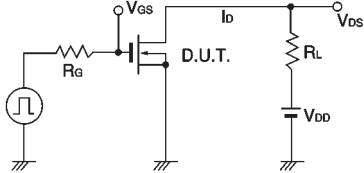

Fig.13 Switching time measurement circuit

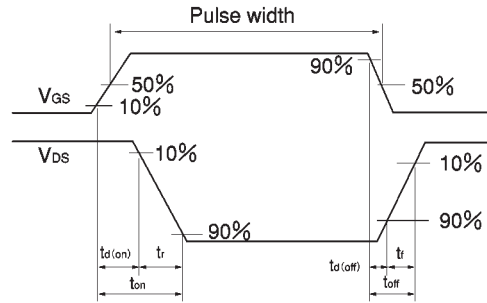

Fig.14 Switching time waveforms